

# MINI TYPE LED LAMPS

## 小型化發光二極體指示

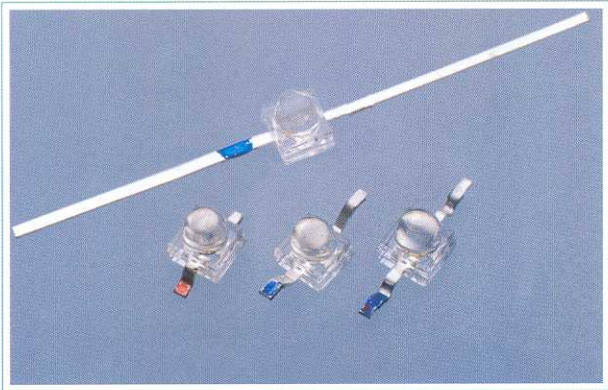

### Recommended Soldering Pattern For Reflow Soldering

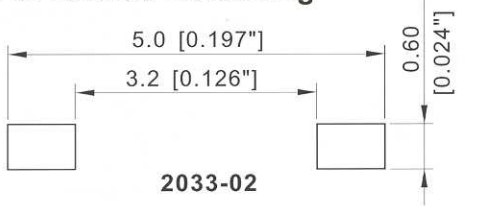

2033-02

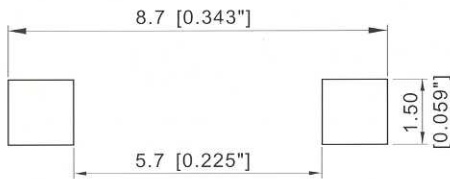

2033-03

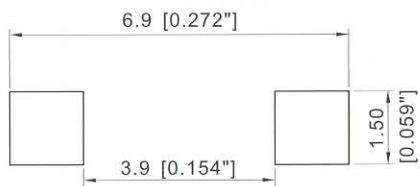

2033-04

### Package Outline Drawing:

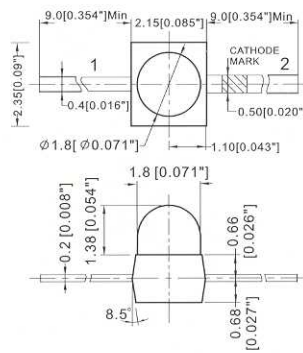

2033-01

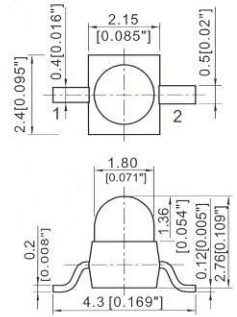

2033-02

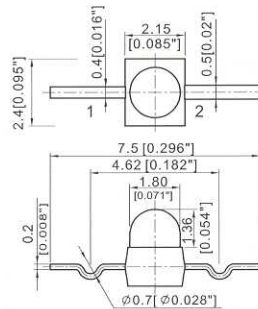

2033-03

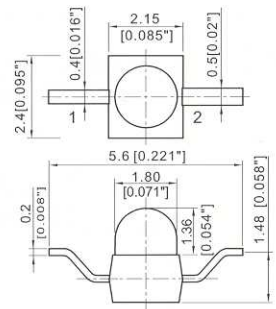

2033-04

NOTES 1. All dimensions are in millimeters (inches);  
2. Tolerances are  $\pm 0.1$ mm (0.004inch) unless otherwise noted;  
3. Resin color: water clear.

### Recommended Reflow Soldering Profile.

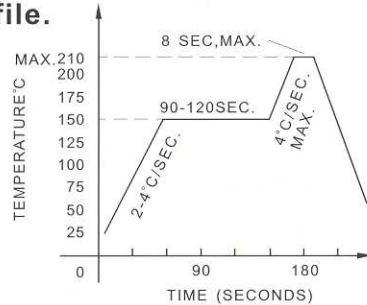

## 1.8mm Round Subminiature Axial LEDs

Part Number	Raw Material	Wave Length $\lambda$ D(nm)	Emitting color	Lens Type	Vf(V) Typ	Iv(mcd) Typ	Viewing angle $2\theta_{1/2}(\circ)$
					At 20mA		
RF-RS2033TS-(01-04)E	GaAlAs	645	Red	Water Clear	1.8	90	20
RF-RU2033TP-(01-04)E	AlGaInP	630	Red	Water Clear	2.0	210	20
RF-OU2033TP-(01-04)E	AlGaInP	620	Orange	Water Clear	2.0	270	20
RF-YU2033TP-(01-04)E	AlGaInP	587	Yellow	Water Clear	2.0	270	20
RF-YG2033TP-(01-04)E	GaP	570	Yellow Green	Water Clear	2.2	72	20
RF-GP2033TP-(01-04)E	AllnGaN	525	Green	Water Clear	3.3	720	20
RF-BN2033TP-(01-04)E	AllnGaN	470	Blue	Water Clear	3.3	215	20
RF-WN2033TP-(01-04)E	AllnGaN		White	diffused	3.3	480	20