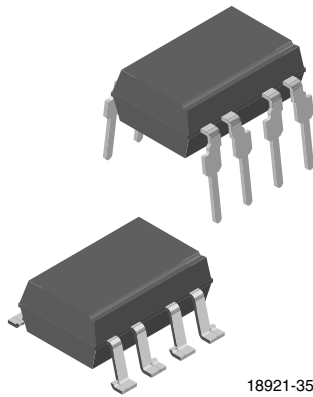
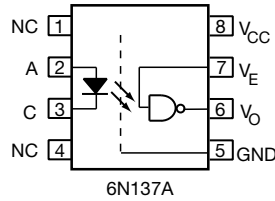


High Speed Optocoupler, 10 MBd



18921-35



Truth Table (Positive Logic)

| LED | ENABLE | OUTPUT |
|-----|--------|--------|
| ON | H | L |
| OFF | H | H |
| ON | L | H |
| OFF | L | H |
| ON | NC | L |
| OFF | NC | H |

FEATURES

- CMR performance of 1 kV/μs
- High speed: 10 MBd typical
- LSTTL/TTL compatibility
- Low input current capability: 5 mA
- Material categorization:
For definitions of compliance please see www.vishay.com/doc?99912



RoHS COMPLIANT

APPLICATIONS

- Microprocessor system interface
- PLC, ATE input/output isolation
- Computer peripheral interface
- Digital fieldbus isolation: CC-link, DeviceNet, profibus, SDS
- High speed A/D and D/A conversion
- AC plasma display panel level shifting
- Multiplexed data transmission
- Digital control power supply
- Ground loop elimination

DESCRIPTION

The 6N137A is single channel 10 MBd optocouplers utilizing a high efficient input LED coupled to a very high speed integrated photo-detector logic gate with a strobable output. This detector features an open collector. The internal shield provides a guaranteed common mode transient immunity of 1 kV/μs. The use of a 0.1 μF bypass capacitor connected between pin 5 and 8 is recommended.

AGENCY APPROVALS

(Parts are certified under base model 6N137A)

- UL1577 file number: E52744, double protection
- cUL tested to CSA 22.2 bulletin 5A
- DIN EN 60747-5-5 (VDE 0884-5), available with option 1
- CQC GB8898, GB4943.1

| ORDERING INFORMATION | |
|---|---|
| <div style="display: flex; justify-content: space-around; align-items: center;"> <div style="text-align: center;"> <div style="border: 1px solid black; padding: 2px 5px;">6</div> <div style="border: 1px solid black; padding: 2px 5px;">N</div> <div style="border: 1px solid black; padding: 2px 5px;">1</div> <div style="border: 1px solid black; padding: 2px 5px;">3</div> <div style="border: 1px solid black; padding: 2px 5px;">7</div> <div style="border: 1px solid black; padding: 2px 5px;">A</div> <div style="border: 1px solid black; padding: 2px 5px;">-</div> <div style="border: 1px solid black; padding: 2px 5px;">X</div> <div style="border: 1px solid black; padding: 2px 5px;">0</div> <div style="border: 1px solid black; padding: 2px 5px;">0</div> <div style="border: 1px solid black; padding: 2px 5px;">#</div> <div style="border: 1px solid black; padding: 2px 5px;">T</div> </div> <div style="margin-left: 20px;"> <p>DIP-8 Option 7</p> </div> </div> | <p style="text-align: center;">PART NUMBER PACKAGE OPTION TAPE AND REEL</p> |
| AGENCY CERTIFIED/PACKAGE | CMR (V/μs) |
| UL, cUL, CQC | 1000 |
| DIP-8 | 6N137A |
| SMD-8, option 7 | 6N137A-X007T |
| VDE, UL, cUL, CQC | 1000 |
| DIP-8 | 6N137A-X001 |
| SMD-8, option 7 | 6N137A-X017T |

Note

- Additional options may be possible, please contact sales office.



| ABSOLUTE MAXIMUM RATINGS ($T_{amb} = 25\text{ }^{\circ}\text{C}$, unless otherwise specified) | | | | |
|--|--------------------|------------|-------------------------|--------------------|
| PARAMETER | TEST CONDITION | SYMBOL | VALUE | UNIT |
| INPUT | | | | |
| Average forward current | | I_F | 20 | mA |
| Reverse input voltage | | V_R | 5 | V |
| Enable input voltage | | V_E | $V_{CC} + 0.5\text{ V}$ | V |
| Enable input current | | I_E | 5 | mA |
| Output power dissipation | | P_{diss} | 35 | mW |
| OUTPUT | | | | |
| Supply voltage | 1 min maximum | V_{CC} | 7 | V |
| Output current | | I_O | 50 | mA |
| Output voltage | | V_O | 7 | V |
| Output power dissipation | | P_{diss} | 85 | mW |
| COUPLER | | | | |
| Isolation test voltage | $t = 1\text{ min}$ | V_{ISO} | 5000 | V_{RMS} |
| Storage temperature | | T_{stg} | - 55 to + 125 | $^{\circ}\text{C}$ |
| Operating temperature | | T_{amb} | - 40 to + 85 | $^{\circ}\text{C}$ |
| Solder reflow temperature ⁽¹⁾ | 5 s | | 260 | $^{\circ}\text{C}$ |

Notes

- Stresses in excess of the absolute maximum ratings can cause permanent damage to the device. Functional operation of the device is not implied at these or any other conditions in excess of those given in the operational sections of this document. Exposure to absolute maximum ratings for extended periods of the time can adversely affect reliability.
- ⁽¹⁾ Refer to reflow profile for soldering conditions for surface mounted devices (SMD). Refer to wave profile for soldering conditions for through hole devices (DIP).

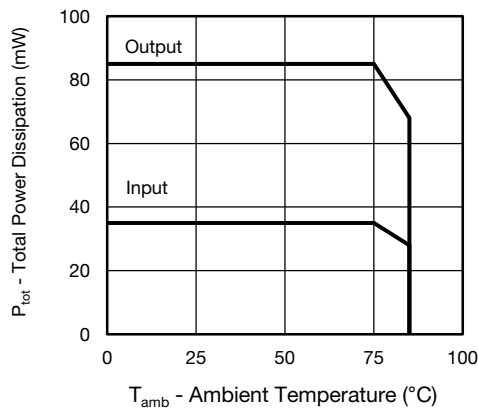


Fig. 1 - Total Power Dissipation vs. Ambient Temperature

| RECOMMENDED OPERATING CONDITIONS | | | | | |
|---|--------------------------|-----------|------|----------|--------------------|
| PARAMETER | TEST CONDITION | SYMBOL | MIN. | MAX. | UNIT |
| Operating temperature | | T_{amb} | - 40 | 85 | $^{\circ}\text{C}$ |
| Supply voltage | | V_{CC} | 4.5 | 5.5 | V |
| Input current low level | | I_{FL} | 0 | 250 | μA |
| Input current high level | | I_{FH} | 5 | 15 | mA |
| Logic high enable voltage | | V_{EH} | 2 | V_{CC} | V |
| Logic low enable voltage | | V_{EL} | 0 | 0.8 | V |
| Output pull up resistor | | R_L | 330 | 4K | Ω |
| Fanout | $R_L = 1\text{ k}\Omega$ | N | | 5 | - |



| ELECTRICAL CHARACTERISTICS ($T_{amb} = 25\text{ }^{\circ}\text{C}$, unless otherwise specified) | | | | | | |
|--|---|-----------------------|------|-------|-------|---------------|
| PARAMETER | TEST CONDITION | SYMBOL | MIN. | TYP. | MAX. | UNIT |
| INPUT | | | | | | |
| Input forward voltage | $I_F = 10\text{ mA}$ | V_F | | 1.35 | 1.7 | V |
| Input forward voltage temperature coefficient | $I_F = 10\text{ mA}$ | $\Delta V_F/\Delta T$ | | - 1.2 | | mV/K |
| Input reverse voltage | $I_R = 10\text{ }\mu\text{A}$ | BV_R | 5 | | | V |
| Input threshold current | $V_E = 2\text{ V}$, $V_{CC} = 5.5\text{ V}$, $I_{OL}(\text{sinking}) = 13\text{ mA}$ | I_{TH} | | 1.8 | 5 | mA |
| Input capacitance | $f = 1\text{ MHz}$, $V_F = 0\text{ V}$ | C_I | | 28 | | pF |
| OUTPUT | | | | | | |
| High level supply current | $V_E = 0.5\text{ V}$, $I_F = 0\text{ mA}$ | I_{CCH} | | 8 | 10 | mA |
| | $V_E = V_{CC}$, $I_F = 10\text{ mA}$ | | | 5.8 | | |
| Low level supply current | $V_E = 0.5\text{ V}$, $I_F = 0\text{ mA}$ | I_{CCL} | | 10 | 13 | mA |
| | $V_E = V_{CC}$, $I_F = 10\text{ mA}$ | | | 8 | | |
| High level enable current | $V_E = 2\text{ V}$ | I_{EH} | | - 0.6 | - 1.6 | mA |
| Low level enable current | $V_E = 0.5\text{ V}$ | I_{EL} | | - 0.9 | - 1.6 | mA |
| High level enable voltage | | V_{EH} | 2 | | | V |
| Low level enable voltage | | V_{EL} | | | 0.8 | V |
| High level output current | $V_E = 2\text{ V}$, $V_{CC} = 5.5\text{ V}$, $V_O = 5.5\text{ V}$, $I_F = 250\text{ }\mu\text{A}$ | I_{OH} | | 0.02 | 100 | μA |
| Low level output voltage | $V_E = 2\text{ V}$, $V_{CC} = 5.5\text{ V}$, $I_F = 5\text{ mA}$, $I_{OL}(\text{sinking}) = 13\text{ mA}$ | V_{OL} | | 0.13 | 0.60 | V |
| Collector emitter capacitance | $f = 1\text{ MHz}$, $T_{amb} = 25\text{ }^{\circ}\text{C}$ | C_{IO} | | 4 | | pF |
| COUPLER | | | | | | |
| Coupling capacitance | $f = 1\text{ MHz}$, $T_{amb} = 25\text{ }^{\circ}\text{C}$ | C_{IO} | | 0.9 | | pF |

Note

- Minimum and maximum values are testing requirements. Typical values are characteristics of the device and are the result of engineering evaluation. Typical values are for information only and are not part of the testing requirements.

| SWITCHING CHARACTERISTICS | | | | | | |
|--|---|-----------------------|------|------|-------------------|------|
| PARAMETER | TEST CONDITION | SYMBOL | MIN. | TYP. | MAX. | UNIT |
| Propagation delay time to high output level | $R_L = 350\text{ }\Omega$, $C_L = 15\text{ pF}$ | t_{PLH} | 25 | 45 | 75 ⁽¹⁾ | ns |
| Propagation delay time to low output level | $R_L = 350\text{ }\Omega$, $C_L = 15\text{ pF}$ | t_{PHL} | 25 | 32 | 75 ⁽¹⁾ | ns |
| Pulse width distortion | $R_L = 350\text{ }\Omega$, $C_L = 15\text{ pF}$ | $ t_{PHL} - t_{PLH} $ | | 13 | 35 | ns |
| Propagation delay skew | $R_L = 350\text{ }\Omega$, $C_L = 15\text{ pF}$ | t_{PSK} | | 16 | 40 | ns |
| Output rise time (10 % to 90 %) | $R_L = 350\text{ }\Omega$, $C_L = 15\text{ pF}$ | t_r | | 27 | | ns |
| Output fall time (90 % to 10 %) | $R_L = 350\text{ }\Omega$, $C_L = 15\text{ pF}$ | t_f | | 10 | | ns |
| Propagation delay time of enable from V_{EH} to V_{EL} | $R_L = 350\text{ }\Omega$, $C_L = 15\text{ pF}$, $V_{EL} = 0\text{ V}$, $V_{EH} = 3\text{ V}$ | t_{ELH} | | 47 | | ns |
| Propagation delay time of enable from V_{EL} to V_{EH} | $R_L = 350\text{ }\Omega$, $C_L = 15\text{ pF}$, $V_{EL} = 0\text{ V}$, $V_{EH} = 3\text{ V}$ | t_{EHL} | | 24 | | ns |

Notes

- Over recommended temperature ($T_{amb} = -40\text{ }^{\circ}\text{C}$ to $+85\text{ }^{\circ}\text{C}$), $V_{CC} = 5\text{ V}$, $I_F = 7.5\text{ mA}$, unless otherwise specified. Typical values applies to $V_{CC} = 5\text{ V}$, $T_{amb} = 25\text{ }^{\circ}\text{C}$

(1) A JEDEC registered data for 6N137A

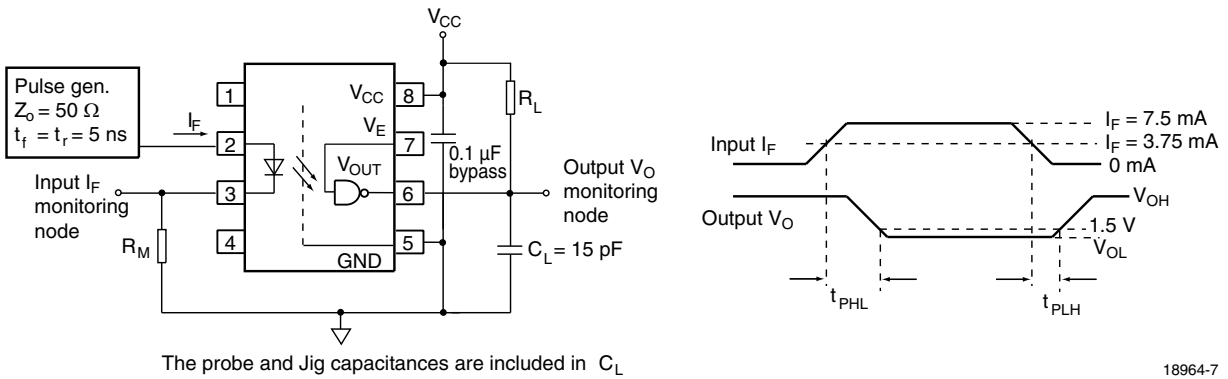


Fig. 2 - Test Circuit for t_{PLH} , t_{PHL} , t_r , and t_f

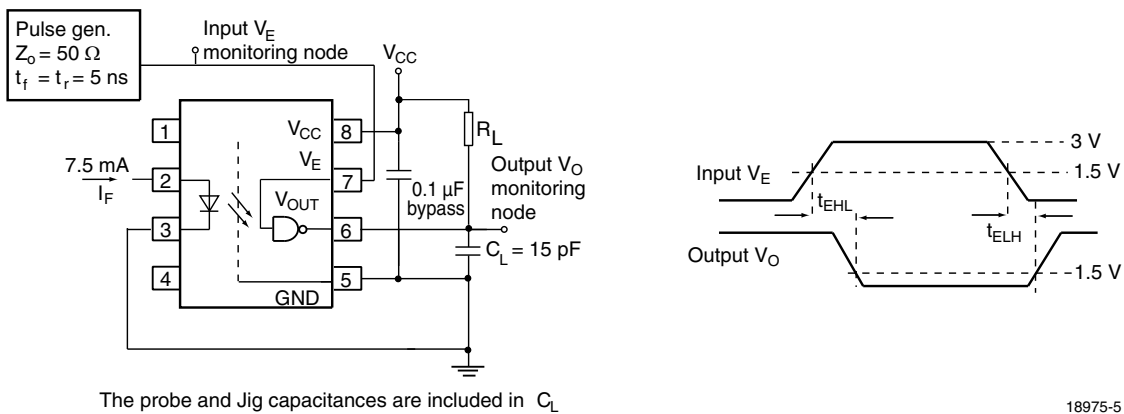


Fig. 3 - Test Circuit for t_{EHL} , and t_{ELH}

| COMMON MODE TRANSIENT IMMUNITY | | | | | | |
|---|---|----------|------|------|------|------------------------|
| PARAMETER | TEST CONDITION | SYMBOL | MIN. | TYP. | MAX. | UNIT |
| Logic high common mode transient immunity ⁽¹⁾⁽³⁾ | $ V_{CM} = 50 \text{ V}$, $V_{CC} = 5 \text{ V}$, $I_F = 0 \text{ mA}$, $V_{O(\min.)} = 2 \text{ V}$, $R_L = 350 \Omega$, $T_{amb} = 25 \text{ }^\circ\text{C}$ | $ CM_H $ | 1000 | | | $\text{V}/\mu\text{s}$ |
| Logic low common mode transient immunity ⁽²⁾⁽³⁾ | $ V_{CM} = 50 \text{ V}$, $V_{CC} = 5 \text{ V}$, $I_F = 7.5 \text{ mA}$, $V_{O(\min.)} = 0 \text{ V}$, $R_L = 350 \Omega$, $T_{amb} = 25 \text{ }^\circ\text{C}$ | $ CM_L $ | 1000 | | | $\text{V}/\mu\text{s}$ |

Notes

- (1) CM_H is the maximum tolerable rate of rise of the common mode voltage to assure that the output will remain in a high logic state (i.e. $V_O > 2.0 \text{ V}$)
- (2) CM_L is the maximum tolerable rate of fall of the common mode voltage to assure that the output will remain in a low logic state (i.e. $V_O > 0.8 \text{ V}$)
- (3) No external pull up is required for a high logic state on the enable input. If the enable pin is not used, trying it to V_{CC} .

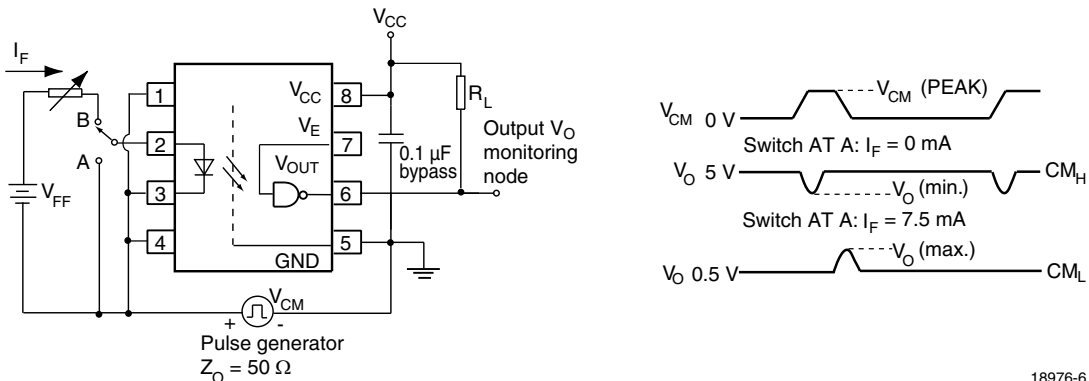


Fig. 4 - Test Circuit for Common Mode Transient Immunity

| SAFETY AND INSULATION RATINGS | | | | |
|--|--|------------|-----------|------------|
| PARAMETER | | SYMBOL | VALUE | UNIT |
| MAXIMUM SAFETY RATINGS | | | | |
| Output safety power | | P_{SO} | 600 | mW |
| Input safety current | | I_{si} | 230 | mA |
| Safety temperature | | T_S | 175 | °C |
| Comparative tracking index | | CTI | 175 | |
| INSULATION RATED PARAMETERS | | | | |
| Maximum withstanding isolation voltage | | V_{ISO} | 5000 | V_{RMS} |
| Maximum transient isolation voltage | | V_{IOTM} | 6000 | V_{peak} |
| Maximum repetitive peak isolation voltage | | V_{IORM} | 630 | V_{peak} |
| Insulation resistance | $T_{amb} = 25\text{ °C}, V_{DC} = 500\text{ V}$ | R_{IO} | 10^{12} | Ω |
| Insulation resistance | $T_{amb} = 100\text{ °C}, V_{DC} = 500\text{ V}$ | R_{IO} | 10^{11} | Ω |
| Climatic classification (according to IEC 68 part 1) | | | 40/85/21 | |
| Environment (pollution degree in accordance to DIN VDE 0109) | | | 2 | |
| Maximum creepage | | | 7 | mm |
| Clearance | | | 7 | mm |
| Insulation thickness | | | 0.4 | mm |

Note

- As per DIN EN 60747-5-5, §7.4.3.8.2, this optocoupler is suitable for “safe electrical insulation” only within the safety ratings. Compliance with the safety ratings shall be ensured by means of protective circuits.

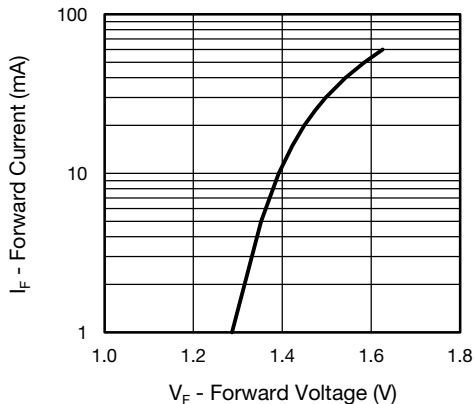
TYPICAL CHARACTERISTICS ($T_{amb} = 25\text{ °C}$, unless otherwise specified)


Fig. 5 - Diode Forward Current vs. Forward Voltage

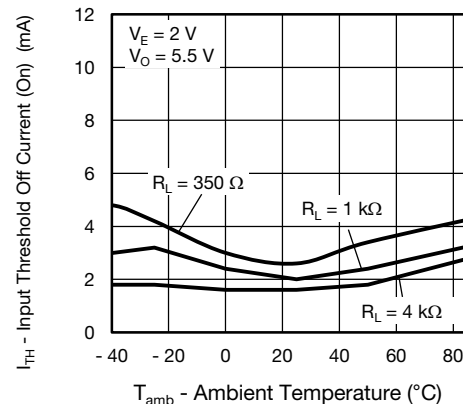


Fig. 7 - Input Threshold Off Current vs. Ambient Temperature

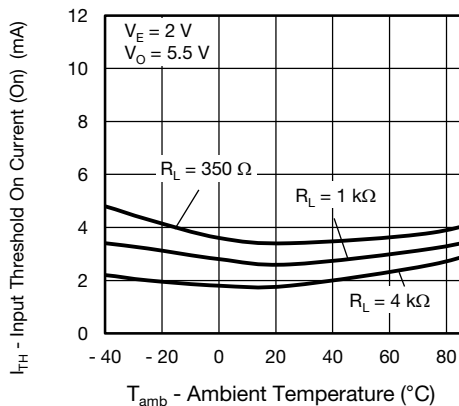


Fig. 6 - Input Threshold On Current vs. Ambient Temperature

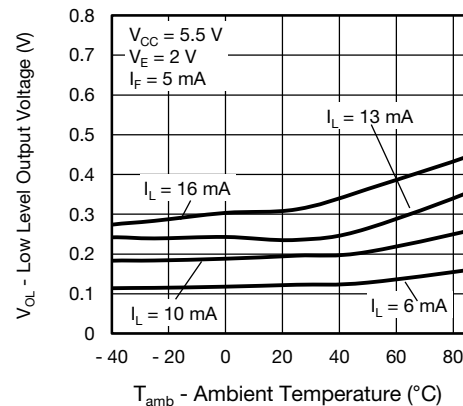


Fig. 8 - Low Level Output Voltage vs. Ambient Temperature

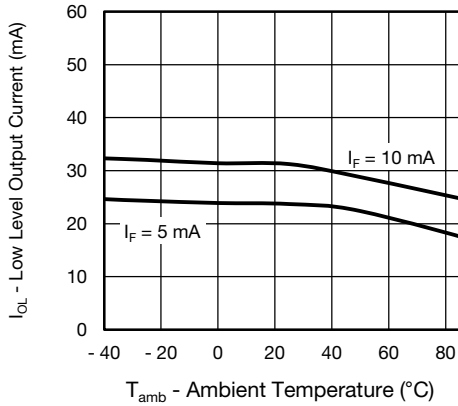


Fig. 9 - Low Level Output Current vs. Ambient Temperature

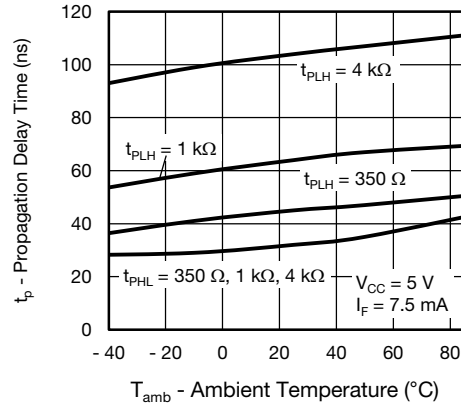


Fig. 12 - Propagation Delay Time vs. Ambient Temperature

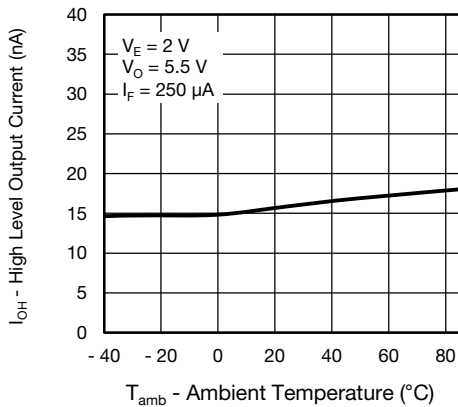


Fig. 10 - High Level Output Current vs. Ambient Temperature

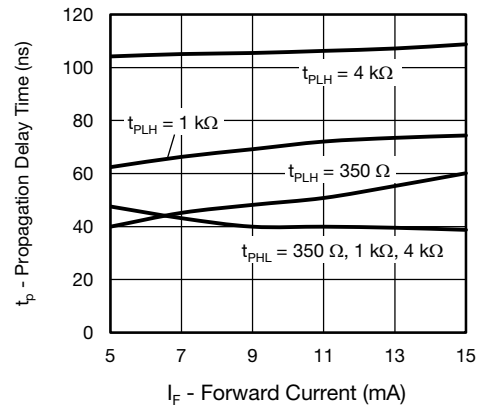


Fig. 13 - Propagation Delay Time vs. Diode Forward Current

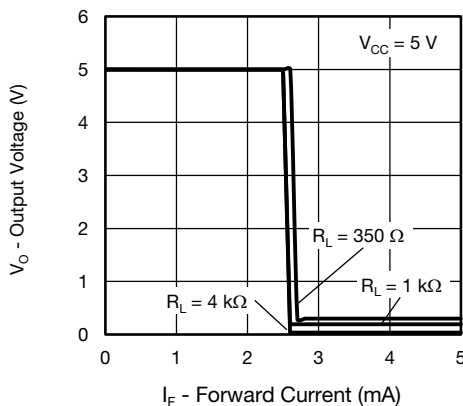


Fig. 11 - Output Voltage vs. Diode Forward Current

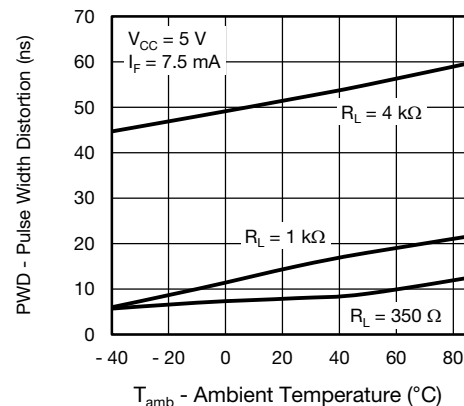


Fig. 14 - Pulse Width Distortion vs. Ambient Temperature

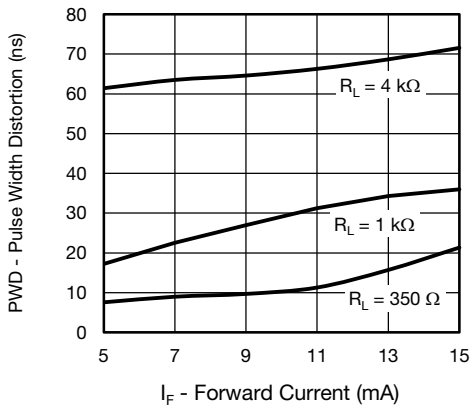


Fig. 15 - Pulse Width Distortion vs. Diode Input Current

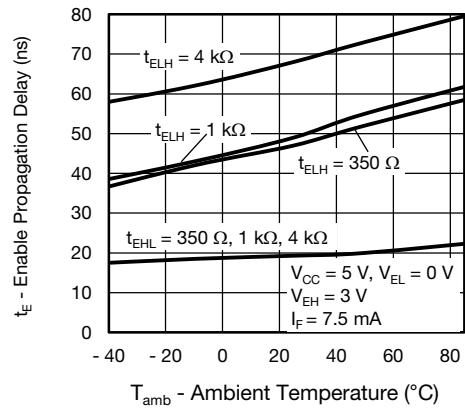


Fig. 17 - Enable Propagation Delay vs. Ambient Temperature

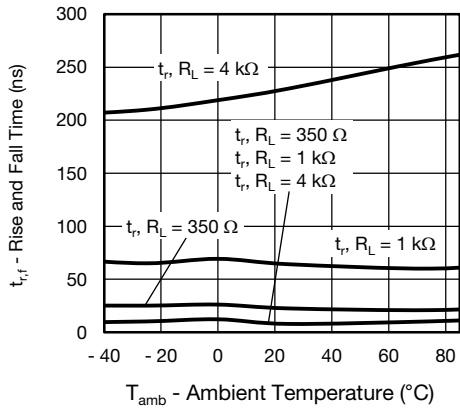


Fig. 16 - Rise And Fall Time vs. Ambient Temperature

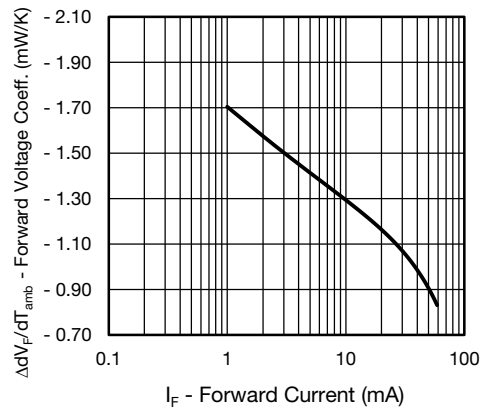
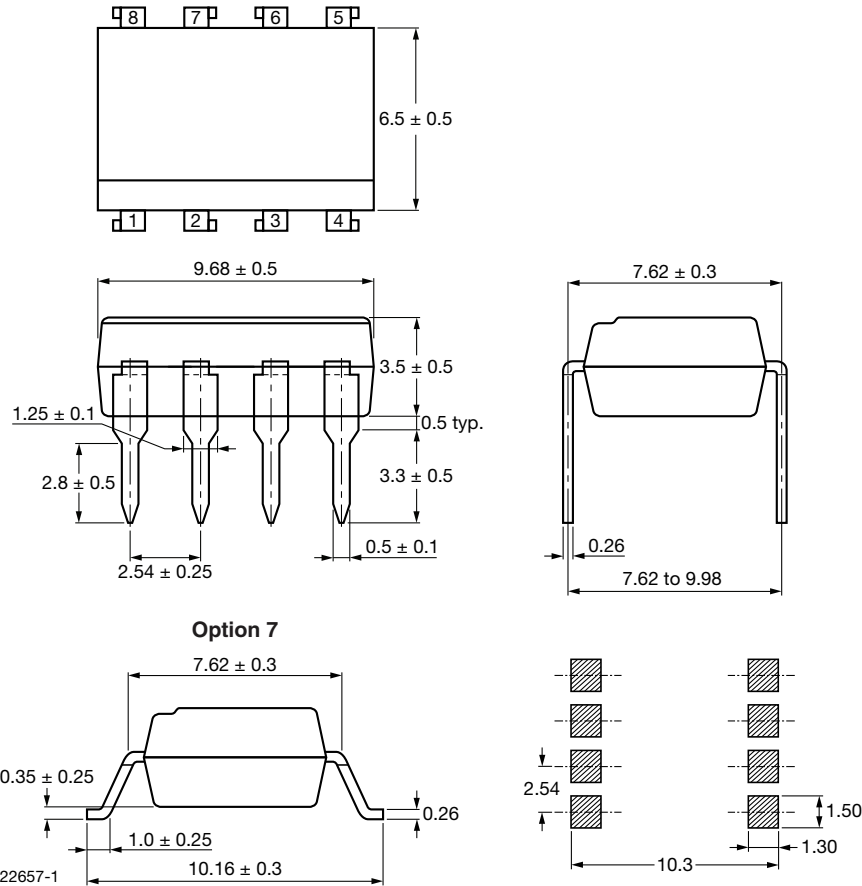
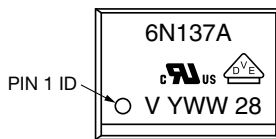


Fig. 18 - Forward Voltage Coefficient vs. Forward Current

PACKAGE DIMENSIONS in millimeters



PACKAGE MARKING



Notes

- VDE logo is only marked on option 1 parts. Option information is not marked on the part.
- Tape and reel suffix (T) is not part of the package marking.

PACKING INFORMATION

| DEVICE PER TUBE OR REEL | | |
|-------------------------|-----------|-----------|
| UNITS/TUBE | TUBES/BOX | UNITS/BOX |
| 50 | 40 | 2000 |

TAPE AND REEL PACKAGING FOR OPTION 7 (dimensions in millimeters)

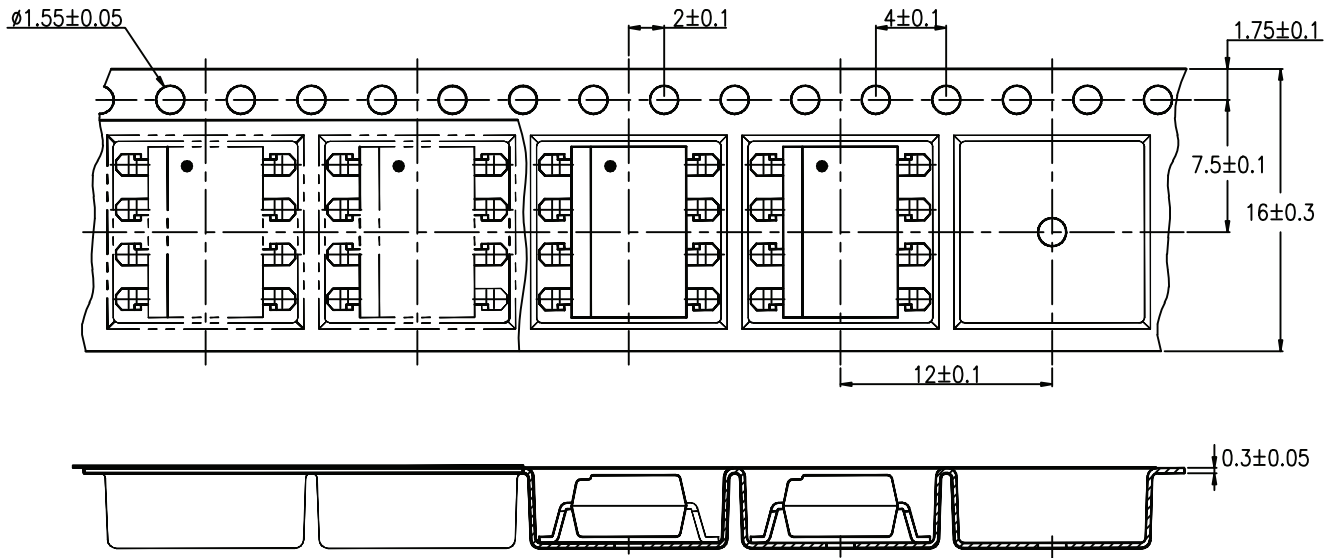


Fig. 19 - Reel Dimensions (1000 units per reel)



Disclaimer

ALL PRODUCT, PRODUCT SPECIFICATIONS AND DATA ARE SUBJECT TO CHANGE WITHOUT NOTICE TO IMPROVE RELIABILITY, FUNCTION OR DESIGN OR OTHERWISE.

Vishay Intertechnology, Inc., its affiliates, agents, and employees, and all persons acting on its or their behalf (collectively, "Vishay"), disclaim any and all liability for any errors, inaccuracies or incompleteness contained in any datasheet or in any other disclosure relating to any product.

Vishay makes no warranty, representation or guarantee regarding the suitability of the products for any particular purpose or the continuing production of any product. To the maximum extent permitted by applicable law, Vishay disclaims (i) any and all liability arising out of the application or use of any product, (ii) any and all liability, including without limitation special, consequential or incidental damages, and (iii) any and all implied warranties, including warranties of fitness for particular purpose, non-infringement and merchantability.

Statements regarding the suitability of products for certain types of applications are based on Vishay's knowledge of typical requirements that are often placed on Vishay products in generic applications. Such statements are not binding statements about the suitability of products for a particular application. It is the customer's responsibility to validate that a particular product with the properties described in the product specification is suitable for use in a particular application. Parameters provided in datasheets and / or specifications may vary in different applications and performance may vary over time. All operating parameters, including typical parameters, must be validated for each customer application by the customer's technical experts. Product specifications do not expand or otherwise modify Vishay's terms and conditions of purchase, including but not limited to the warranty expressed therein.

Except as expressly indicated in writing, Vishay products are not designed for use in medical, life-saving, or life-sustaining applications or for any other application in which the failure of the Vishay product could result in personal injury or death. Customers using or selling Vishay products not expressly indicated for use in such applications do so at their own risk. Please contact authorized Vishay personnel to obtain written terms and conditions regarding products designed for such applications.

No license, express or implied, by estoppel or otherwise, to any intellectual property rights is granted by this document or by any conduct of Vishay. Product names and markings noted herein may be trademarks of their respective owners.