

PLEASE CHECK WWW.MOLEX.COM FOR LATEST PART INFORMATION

Part Number: [0393730008](#)
Status: **Active**
Description: 7.50mm (.295") Beau™ Eurostyle™ Horizontal PCB Header, Closed Ends, 8 Circuits

Documents:

[3D Model](#) [RoHS Certificate of Compliance \(PDF\)](#)
[Drawing \(PDF\)](#)

Agency Certification

UL E48521

General

Product Family	Terminal Blocks
Series	39373
Application	Wire-to-Board
Component Type	PCB Header
Product Literature Order No	USA-261
Product Name	Eurostyle™ Pluggable
Type	Euro Block

Physical

Circuits (Loaded)	8
Circuits (maximum)	8
Entry Angle	90° Angle
Flammability	94V-0
Lock to Mating Part	None
Number of Rows	1
Orientation	Right Angle
PC Tail Length (in)	1.138 In
PC Tail Length (mm)	3.50 mm
PCB Retention	None
Panel Mount	No
Pitch - Mating Interface (in)	0.295 In
Pitch - Mating Interface (mm)	7.50 mm
Pitch - Term. Interface (in)	0.295 In
Pitch - Term. Interface (mm)	7.50 mm
Polarized to Mating Part	Yes
Shrouded	Closed Ends
Stackable	No
Surface Mount Compatible (SMC)	No
Temperature Range - Operating	110°C
Wire Size AWG	N/A

Electrical

Current - Maximum per Contact	15A
Voltage - Maximum	300V

Material Info

Old Part Number	371908
-----------------	--------

Reference - Drawing Numbers

Sales Drawing	SD-39373-001
---------------	--------------

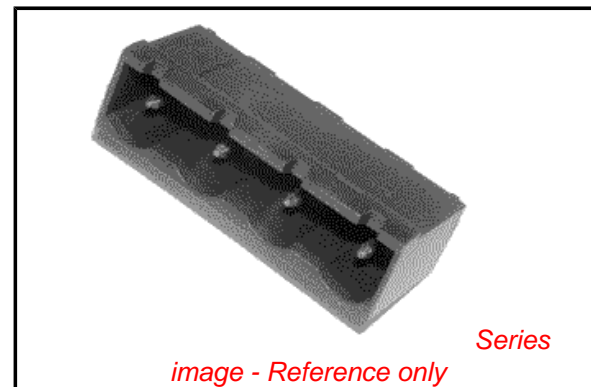

EU RoHS

**ELV and RoHS
Compliant**
REACH SVHC
 Not Reviewed
**Halogen-Free
Status**
 Not Reviewed

China RoHS



**Need more information on product
environmental compliance?**

Email productcompliance@molex.com
 For a multiple part number RoHS Certificate of
 Compliance, [click here](#)

Please visit the [Contact Us](#) section for any
 non-product compliance questions.

Search Parts in this Series

39373Series

Mates With

39371 & 39374 Plugs

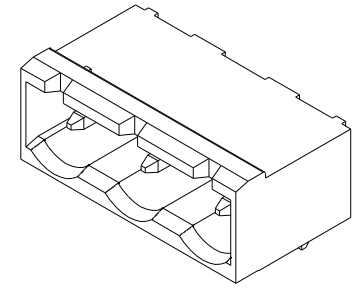
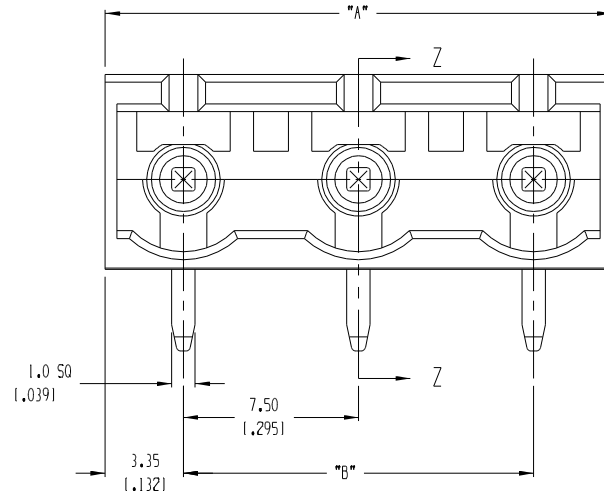
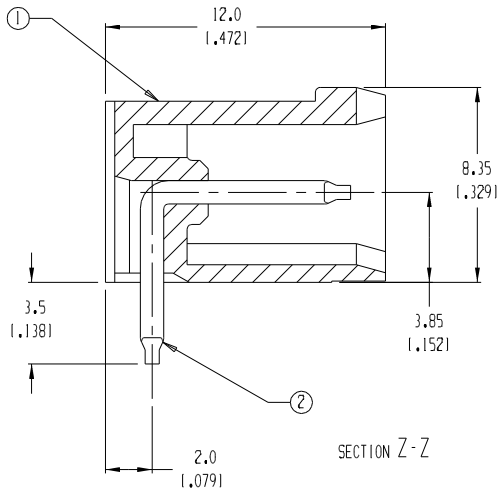

AUX. VIEW
SCALE 3:1

MATERIAL NUMBER	NUMBER OF CIRCUITS "XX"	A		B	
039373-0002	2	14.2	(0.56)	7.50	(1.295)
039373-0003	3	21.7	(0.85)	15.00	(1.591)
039373-0004	4	29.2	(1.15)	22.50	(1.886)
039373-0005	5	36.7	(1.44)	30.00	(1.181)
039373-0006	6	44.2	(1.74)	37.50	(1.476)
039373-0007	7	51.7	(2.04)	45.00	(1.772)
039373-0008	8	59.2	(2.33)	52.50	(2.067)
039373-0009	9	66.7	(2.63)	60.00	(2.362)
039373-0010	10	74.2	(2.92)	67.50	(2.657)
039373-0011	11	81.7	(3.22)	75.00	(2.953)
039373-0012	12	89.2	(3.51)	82.50	(3.248)

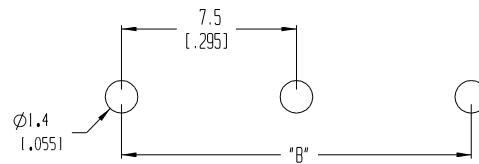

PTH PATTERN
RECOMMENDED

- NOTES:
1. MATERIAL: SEE TABLE
 2. FINISHES: SEE TABLE
 3. PRODUCT SPECIFICATION: NOT REQUIRED
 4. PACKAGING: NOT REQUIRED
 5. MATES WITH: 7MM PLUG
 6. "XX" - REFERS TO THE NUMBER OF CIRCUIT POSITIONS

ITEM	QTY.	DESCRIPTION	MATERIAL	FINISH
2	XX	PIN	PHOS. BRONZE	TIN-PLATED
1	1	HOUSING	POLYIMIDE	BLACK

EC NO. 3846 DRAWN: CY 09-03-04 CH'K: APPR:	QUALITY SYMBOLS MAJOR : CRITICAL : SPC : S :	GENERAL TOLERANCES: (UNLESS SPECIFIED) mm INCH 4 PLACES ±.0015 3 PLACES ±.038 ±.005 2 PLACES ±.13 ±.01 1 PLACE ±.3 ANGULAR: ±2°	SCALE 5:1 DESIGN UNITS <input type="checkbox"/> mm <input checked="" type="checkbox"/> INCH	DRAWN BY & DATE W HOWARD 07/21/03 CHECKED BY & DATE R. KEMP 07/23/03 APPROVED BY & DATE P. WALTZ 07/23/03	PROJECT NO. - DIMENSIONS: <input checked="" type="checkbox"/> mm <input type="checkbox"/> INCH <input type="checkbox"/> mm ONLY SHT REV REVISE ON CAD ONLY
	TITLE: 7.5MM RA, HEADER				
	MOLEX INCORPORATED				
	CAD FILENAME 3719XX		MATERIAL NO. SEE CHART	DRAWING NO. SD-39373-001	SHEET NO. 1 OF 1

THIS DRAWING CONTAINS INFORMATION THAT IS PROPRIETARY TO MOLEX INCORPORATED AND SHOULD NOT BE USED WITHOUT WRITTEN PERMISSION.

SIZE B