

SMTT-90H

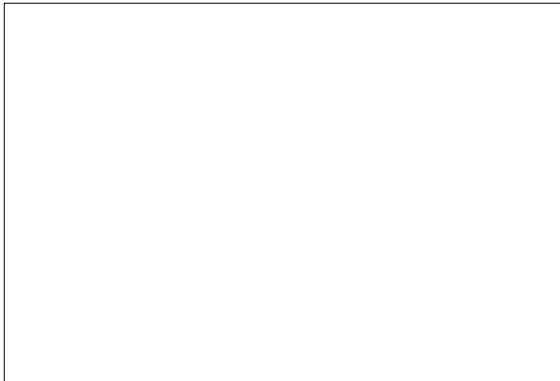

Thyristor-Thyristor Module



Type	V_{RSM}	V_{RRM} , V_{DRM}
SMTT-90H-08	1000	800
SMTT-90H-12	1400	1200
SMTT-90H-14	1600	1400
SMTT-90H-16	1800	1600
SMTT-90H-18	2000	1800
SMTT-90H-20	2200	2000
SMTT-90H-22	2400	2200
SMTT-90H-24	2600	2400

Type	I_{TAVM}	I_{TRMS}	T_c	I_{TSM}	$(di/dt)_{cr}$	$(dv/dt)_{cr}$	V_{TM}	I_{TM}	V_{TO}	r_T	t_q	V_{GT}	I_{GT}	T_{VJM}	V_{isol}	R_{thJC}
	A	A	°C	kA	A/μs	V/μs	V	A	V	mΩ	μs	V	mA	°C	V	K/W
SMTT-90H	90	200	85	2.0	50	800	1.94	270	0.85	3.7	150	2.5	100	125	2500	0.28

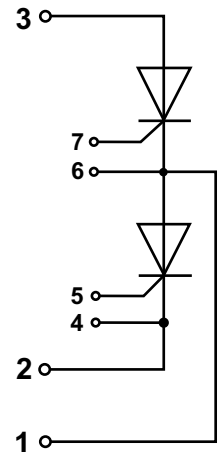
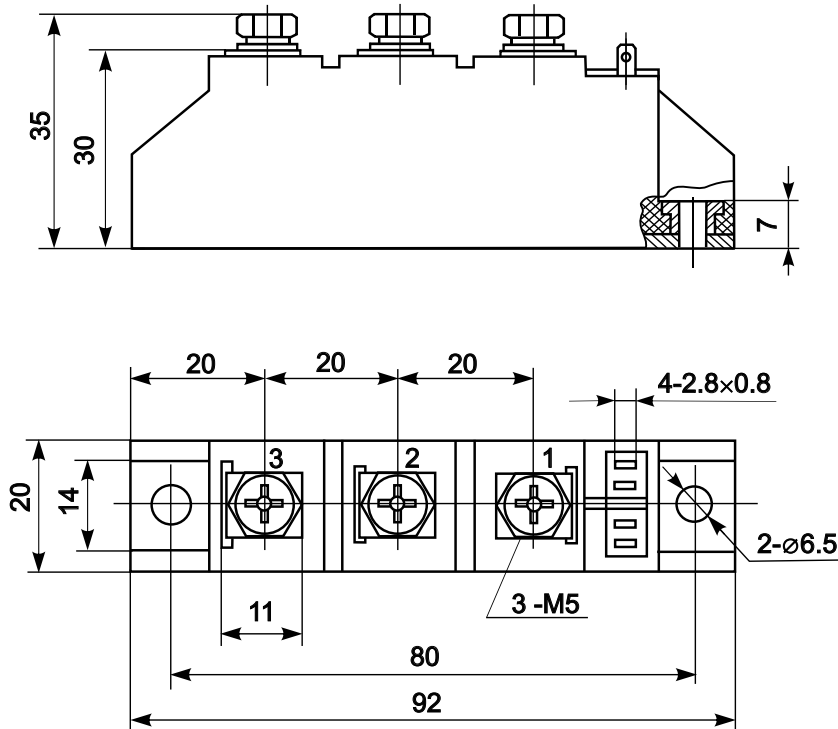

Features:

- Industrial standard package
- Heat transfer through aluminium nitride ceramic isolated metal baseplate
- Precise internal pressure contacts for high reliability
- 2500V RMS isolation voltage

Typical Applications:

- DC motor control
- AC motor soft starter
- Temperature control (e.g. for ovens, chemical processes)
- Lighting control