



MCH3007

RF Transistor

12V, 30mA, $f_T=8\text{GHz}$, NPN Single MCPH3

ON Semiconductor®

<http://onsemi.com>

Features

- Low-noise use : $NF=1.2\text{dB}$ typ ($f=1\text{GHz}$)
- High cut-off frequency : $f_T=8\text{GHz}$ typ ($V_{CE}=5\text{V}$)
- High gain : $|S_{21e}|^2=12\text{dB}$ typ ($f=1\text{GHz}$)
- Halogen free compliance

Specifications

Absolute Maximum Ratings at $T_a=25^\circ\text{C}$

Parameter	Symbol	Conditions	Ratings	Unit
Collector-to- Base Voltage	V_{CBO}		20	V
Collector-to-Emitter Voltage	V_{CEO}		12	V
Emitter-to-Base Voltage	V_{EBO}		2	V
Collector Current	I_C		30	mA
Collector Dissipation	P_C		350	mW
Junction Temperature	T_j		150	$^\circ\text{C}$
Storage Temperature	T_{stg}		-55 to +150	$^\circ\text{C}$

Stresses exceeding Maximum Ratings may damage the device. Maximum Ratings are stress ratings only. Functional operation above the Recommended Operating Conditions is not implied. Extended exposure to stresses above the Recommended Operating Conditions may affect device reliability.

Package Dimensions

unit : mm (typ)

7019A-004

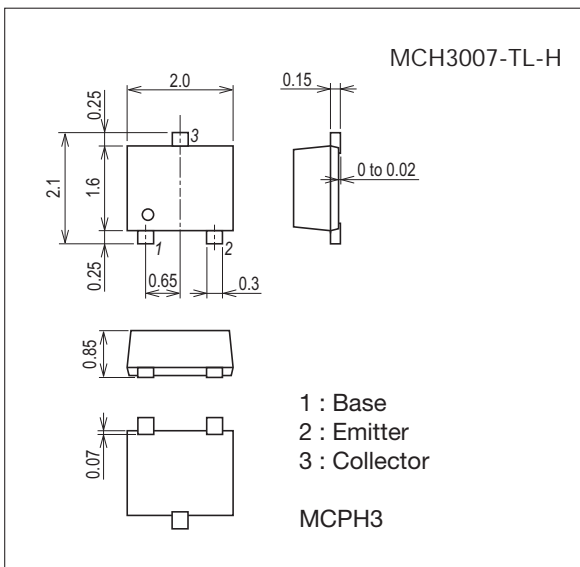

Product & Package Information

- Package : MCPH3
- JEITA, JEDEC : SC-70, SOT-323
- Minimum Packing Quantity : 3,000 pcs./reel

Packing Type : TL

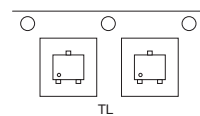

Marking



Electrical Connection

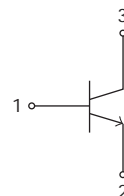

MCH3007

Electrical Characteristics at Ta=25°C

Parameter	Symbol	Conditions	Ratings			Unit
			min	typ	max	
Collector Cutoff Current	ICBO	V _{CB} =5V, I _E =0A			1.0	μA
Emitter Cutoff Current	IEBO	V _{EB} =1V, I _C =0A			1.0	μA
DC Current Gain	h _{FE}	V _{CE} =5V, I _C =5mA	60		150	
Gain-Bandwidth Product	f _T	V _{CE} =5V, I _C =10mA	6	8		GHz
Forward Transfer Gain	S _{21e} ²	V _{CE} =5V, I _C =10mA, f=1GHz	9	12		dB
Noise Figure	NF	V _{CE} =5V, I _C =10mA, f=1GHz		1.2	1.8	dB

Pay attention to handling since it is liable to be affected by static electricity due to the high-frequency process adopted.

Ordering Information

Device	Package	Shipping	memo
MCH3007-TL-H	MCPH3	3,000pcs./reel	Pb Free and Halogen Free

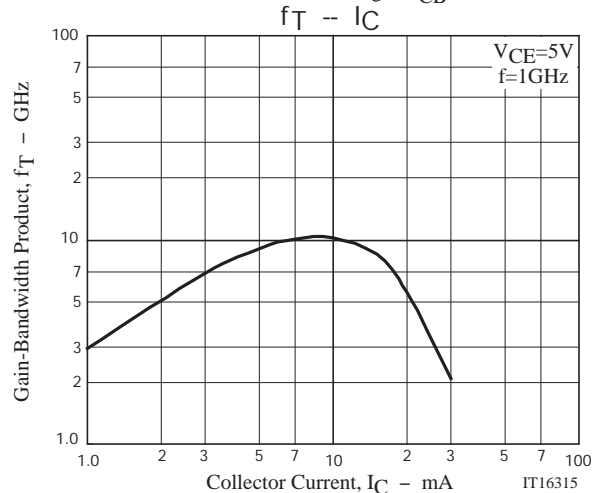
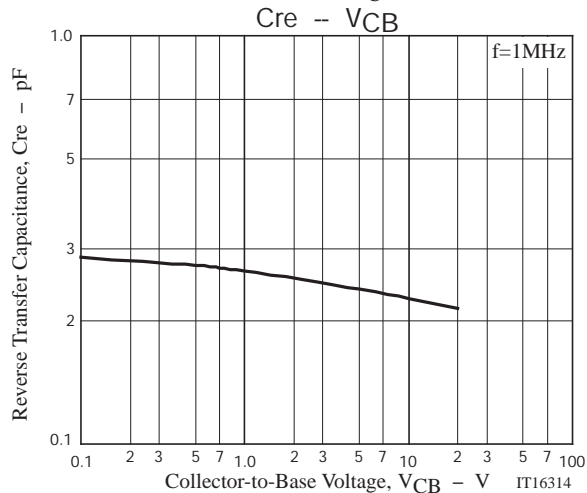
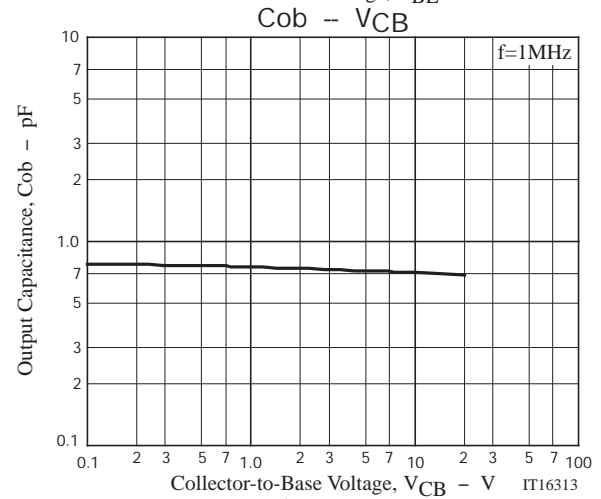
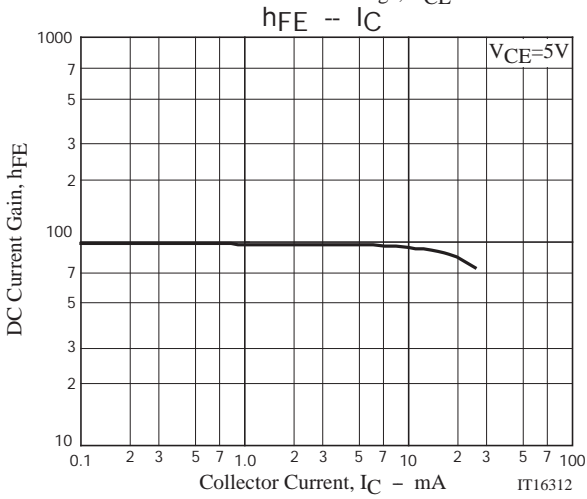
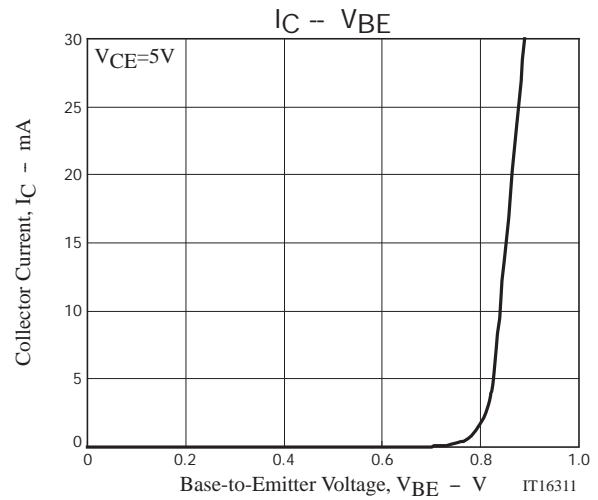
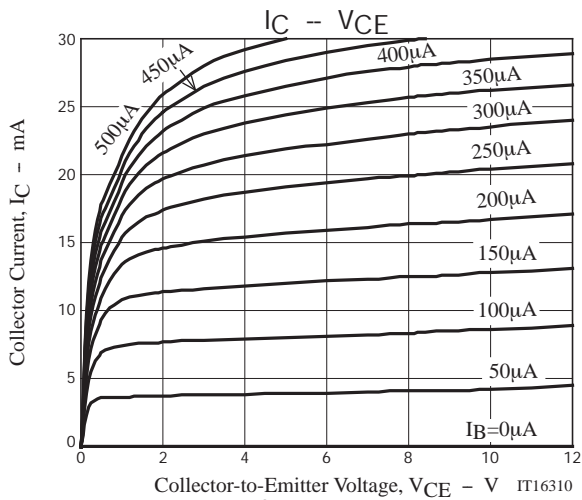

MCH3007

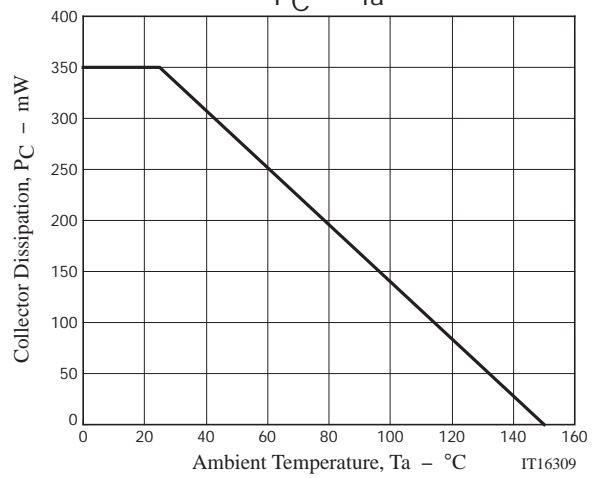
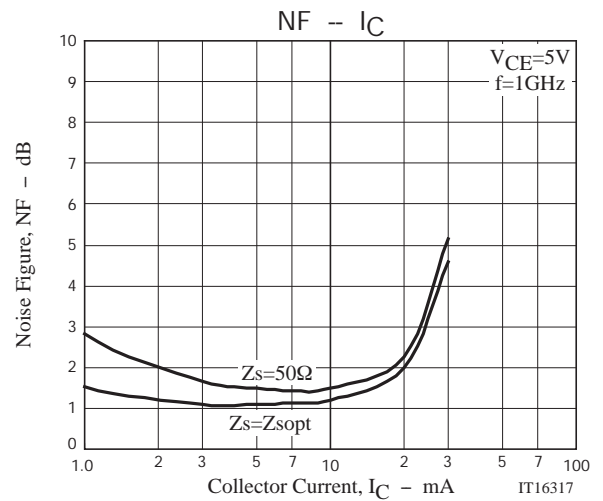
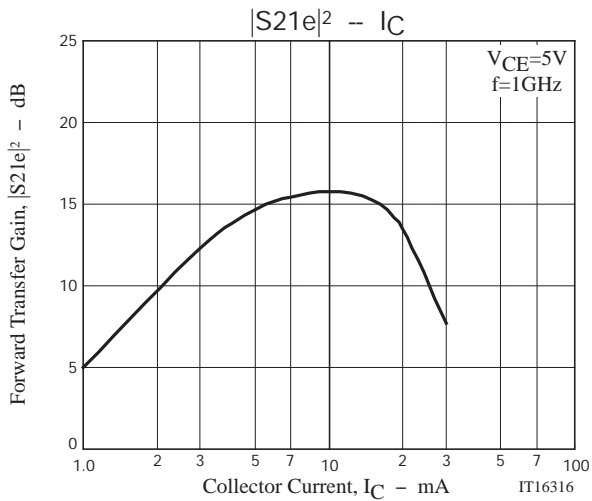

S Parameters (Common emitter)

$V_{CE}=3V, I_C=5mA$

Freq(MHz)	$ S_{11} $	$\angle S_{11}$	$ S_{21} $	$\angle S_{21}$	$ S_{12} $	$\angle S_{12}$	$ S_{22} $	$\angle S_{22}$
100	0.889	-11.8	9.020	164.0	0.011	87.1	0.978	-9.1
200	0.872	-18.1	8.560	151.7	0.026	81.8	0.945	-17.9
300	0.802	-32.2	8.281	142.9	0.037	77.5	0.892	-25.3
400	0.784	-37.9	7.883	136.4	0.046	74.5	0.843	-32.1
500	0.687	-55.5	7.588	125.7	0.057	71.6	0.771	-39.3
600	0.651	-64.3	7.221	119.3	0.065	70.4	0.724	-43.5
700	0.591	-76.2	6.686	111.7	0.073	69.0	0.675	-48.4
800	0.535	-85.9	6.254	105.1	0.080	68.2	0.632	-52.3
900	0.498	266.2	5.783	100.0	0.086	67.7	0.598	-55.7
1000	0.450	258.0	5.404	94.8	0.093	67.9	0.562	-58.4
1200	0.389	244.7	4.684	86.9	0.105	68.1	0.514	-63.0
1400	0.352	234.1	4.101	80.8	0.118	68.7	0.482	-66.0
1600	0.322	224.9	3.651	75.6	0.131	69.4	0.463	-68.3
1800	0.300	216.6	3.291	70.9	0.146	70.1	0.447	-70.1
2000	0.282	208.5	3.004	66.6	0.161	70.5	0.437	-71.9
2200	0.266	200.9	2.776	62.6	0.177	70.7	0.435	-73.7
2400	0.258	193.5	2.586	58.5	0.194	70.6	0.433	-76.6
2600	0.246	186.5	2.415	55.0	0.211	70.5	0.428	-78.6
2800	0.243	180.9	2.292	51.7	0.231	70.4	0.435	-80.0
3000	0.250	174.2	2.191	47.7	0.252	69.3	0.450	-83.4

MCH3007

S Parameters (Common emitter)

V_{CE}=3V, I_C=10mA

Freq(MHz)	S ₁₁	∠S ₁₁	S ₂₁	∠S ₂₁	S ₁₂	∠S ₁₂	S ₂₂	∠S ₂₂
100	0.772	-19.6	14.343	158.2	0.013	80.2	0.952	-12.0
200	0.726	-30.9	13.500	143.9	0.022	77.5	0.880	-22.0
300	0.614	-53.6	12.251	130.6	0.031	75.2	0.798	-28.8
400	0.570	-64.5	11.116	122.3	0.038	74.7	0.734	-34.3
500	0.471	-86.8	9.957	110.0	0.046	74.0	0.660	-40.2
600	0.440	262.6	8.696	103.7	0.053	74.4	0.616	-43.1
700	0.404	251.3	7.844	97.4	0.061	74.8	0.577	-46.7
800	0.380	242.5	6.991	92.7	0.068	75.3	0.543	-49.6
900	0.362	235.0	6.325	88.6	0.075	75.7	0.519	-52.1
1000	0.344	228.3	5.731	85.1	0.083	76.0	0.492	-54.3
1200	0.321	216.8	4.838	79.0	0.098	76.7	0.461	-58.0
1400	0.308	207.2	4.189	74.0	0.113	77.0	0.443	-60.4
1600	0.296	199.1	3.703	69.6	0.129	77.2	0.434	-62.6
1800	0.287	191.6	3.324	65.5	0.146	77.2	0.428	-64.4
2000	0.282	184.3	3.023	61.6	0.164	76.9	0.425	-66.3
2200	0.275	177.4	2.784	57.9	0.182	76.5	0.429	-68.5
2400	0.274	171.5	2.591	54.2	0.201	75.7	0.432	-71.7
2600	0.269	165.4	2.413	50.8	0.220	75.1	0.432	-74.0
2800	0.270	160.9	2.285	47.8	0.242	74.3	0.442	-75.8
3000	0.281	155.9	2.182	44.0	0.266	72.7	0.460	-79.7

V_{CE}=3V, I_C=15mA

Freq(MHz)	S ₁₁	∠S ₁₁	S ₂₁	∠S ₂₁	S ₁₂	∠S ₁₂	S ₂₂	∠S ₂₂
100	0.655	-30.6	16.942	153.3	0.011	76.6	0.912	-13.3
200	0.578	-51.1	14.095	136.7	0.020	73.6	0.814	-22.0
300	0.473	-82.5	12.741	120.1	0.026	73.3	0.735	-26.7
400	0.432	260.6	11.464	110.2	0.033	74.3	0.682	-30.1
500	0.403	240.3	9.665	100.5	0.039	75.4	0.624	-34.4
600	0.395	230.3	7.746	94.9	0.045	77.1	0.595	-36.4
700	0.390	220.9	6.764	89.7	0.052	79.1	0.570	-39.3
800	0.387	213.3	5.958	85.7	0.059	80.2	0.547	-41.8
900	0.386	207.3	5.331	81.9	0.067	81.4	0.533	-44.0
1000	0.381	201.6	4.798	78.8	0.074	82.1	0.515	-46.2
1200	0.379	192.3	4.009	73.0	0.090	83.1	0.498	-50.2
1400	0.380	184.7	3.460	68.0	0.106	83.8	0.491	-53.3
1600	0.378	178.1	3.047	63.5	0.124	84.1	0.491	-56.3
1800	0.378	171.9	2.733	59.3	0.143	83.9	0.491	-59.2
2000	0.380	165.9	2.482	55.2	0.162	83.7	0.493	-62.2
2200	0.379	160.0	2.282	51.4	0.183	83.0	0.502	-65.4
2400	0.383	155.1	2.118	47.5	0.205	82.0	0.508	-69.5
2600	0.383	149.7	1.968	44.0	0.227	81.0	0.510	-72.8
2800	0.386	145.4	1.860	40.8	0.253	79.8	0.523	-75.6
3000	0.398	141.2	1.771	36.9	0.280	77.7	0.544	-80.4

MCH3007

S Parameters (Common emitter)

$V_{CE}=3V, I_C=20mA$

Freq(MHz)	S11	$\angle S11$	S21	$\angle S21$	S12	$\angle S12$	S22	$\angle S22$
100	0.542	-48.6	17.664	147.6	0.011	72.1	0.855	-13.7
200	0.472	-85.2	13.659	127.1	0.018	65.7	0.759	-19.6
300	0.442	241.9	10.775	110.5	0.023	68.0	0.699	-22.4
400	0.437	225.3	8.448	101.0	0.028	72.9	0.667	-24.8
500	0.458	210.5	6.847	92.9	0.033	76.5	0.628	-28.3
600	0.464	203.4	5.771	87.9	0.039	80.6	0.611	-30.2
700	0.475	196.8	4.937	83.2	0.046	82.9	0.597	-33.1
800	0.480	191.5	4.332	79.4	0.053	84.9	0.584	-35.8
900	0.486	187.1	3.842	75.8	0.060	86.7	0.576	-38.3
1000	0.487	183.0	3.458	72.6	0.068	87.8	0.565	-40.9
1200	0.492	176.0	2.876	66.7	0.084	89.4	0.557	-45.7
1400	0.497	170.0	2.478	61.7	0.102	90.4	0.556	-49.9
1600	0.500	164.4	2.179	56.9	0.121	90.6	0.561	-53.9
1800	0.503	159.0	1.952	52.4	0.142	90.4	0.565	-57.9
2000	0.508	153.8	1.771	48.2	0.165	89.7	0.569	-61.9
2200	0.510	148.4	1.625	44.3	0.189	88.6	0.579	-66.1
2400	0.515	143.7	1.503	40.3	0.214	87.2	0.587	-71.0
2600	0.517	138.5	1.392	36.8	0.240	85.6	0.588	-75.3
2800	0.520	134.0	1.311	33.8	0.270	83.8	0.600	-78.9
3000	0.529	129.8	1.243	30.0	0.301	81.0	0.622	-84.4

$V_{CE}=5V, I_C=5mA$

Freq(MHz)	S11	$\angle S11$	S21	$\angle S21$	S12	$\angle S12$	S22	$\angle S22$
100	0.893	-11.5	9.065	164.4	0.013	88.3	0.978	-8.8
200	0.878	-17.5	8.626	152.2	0.025	80.9	0.949	-17.3
300	0.809	-31.3	8.332	143.4	0.036	79.1	0.898	-24.4
400	0.792	-36.9	7.943	137.0	0.045	75.9	0.852	-31.1
500	0.696	-54.2	7.444	126.3	0.055	72.7	0.782	-38.2
600	0.659	-62.9	6.985	119.8	0.063	71.1	0.736	-42.3
700	0.599	-74.6	6.740	112.3	0.071	69.9	0.687	-47.1
800	0.542	-84.3	6.322	105.6	0.078	69.2	0.644	-51.0
900	0.504	268.0	5.839	100.6	0.084	68.6	0.610	-54.3
1000	0.455	259.8	5.465	95.2	0.090	68.4	0.573	-57.1
1200	0.392	246.7	4.739	87.3	0.103	68.8	0.526	-61.6
1400	0.353	236.1	4.152	81.2	0.116	69.6	0.495	-64.5
1600	0.323	227.1	3.696	75.9	0.129	70.3	0.475	-66.7
1800	0.299	218.7	3.332	71.2	0.143	70.8	0.460	-68.5
2000	0.281	210.6	3.040	66.9	0.158	71.4	0.450	-70.3
2200	0.263	203.0	2.809	62.9	0.174	71.7	0.447	-72.2
2400	0.255	195.6	2.618	58.8	0.191	71.6	0.446	-75.1
2600	0.242	188.7	2.444	55.2	0.208	71.5	0.442	-77.1
2800	0.239	183.0	2.320	51.9	0.228	71.4	0.449	-78.4
3000	0.246	176.1	2.218	47.9	0.250	70.3	0.464	-81.9

MCH3007

S Parameters (Common emitter)

V_{CE}=5V, I_C=10mA

Freq(MHz)	S ₁₁	∠S ₁₁	S ₂₁	∠S ₂₁	S ₁₂	∠S ₁₂	S ₂₂	∠S ₂₂
100	0.792	-17.6	14.870	159.5	0.013	88.0	0.957	-11.5
200	0.754	-27.7	13.544	145.4	0.022	77.9	0.892	-21.2
300	0.642	-48.6	12.776	132.5	0.030	77.7	0.815	-28.1
400	0.601	-58.2	11.567	124.3	0.037	75.8	0.751	-33.7
500	0.489	-79.8	10.460	111.9	0.045	75.0	0.677	-39.6
600	0.452	269.8	9.468	105.4	0.053	75.3	0.632	-42.7
700	0.410	258.3	8.253	98.9	0.060	75.7	0.592	-46.4
800	0.380	249.3	7.358	94.0	0.067	76.0	0.556	-49.3
900	0.359	241.6	6.641	89.8	0.075	76.4	0.530	-51.8
1000	0.338	234.7	6.018	86.3	0.082	76.6	0.503	-54.1
1200	0.310	222.9	5.069	80.2	0.097	77.1	0.470	-57.7
1400	0.294	213.1	4.384	75.2	0.112	77.4	0.450	-60.0
1600	0.280	204.7	3.871	70.7	0.129	77.5	0.441	-62.1
1800	0.270	196.8	3.472	66.6	0.145	77.4	0.433	-63.8
2000	0.262	189.2	3.157	62.8	0.162	77.1	0.429	-65.6
2200	0.254	182.2	2.905	59.2	0.181	76.8	0.432	-67.6
2400	0.253	176.0	2.700	55.5	0.199	75.9	0.435	-70.7
2600	0.246	169.6	2.514	52.1	0.218	75.2	0.435	-72.9
2800	0.247	165.1	2.381	49.1	0.239	74.5	0.445	-74.5
3000	0.258	159.8	2.273	45.3	0.263	72.9	0.462	-78.3

V_{CE}=5V, I_C=15mA

Freq(MHz)	S ₁₁	∠S ₁₁	S ₂₁	∠S ₂₁	S ₁₂	∠S ₁₂	S ₂₂	∠S ₂₂
100	0.691	-25.3	18.098	155.5	0.011	81.7	0.936	-12.7
200	0.628	-41.7	16.001	139.7	0.020	76.6	0.847	-22.0
300	0.505	-68.7	14.151	123.7	0.027	76.2	0.766	-27.6
400	0.452	-83.3	12.511	114.0	0.033	77.5	0.706	-31.7
500	0.394	256.4	10.390	103.8	0.040	77.5	0.640	-36.6
600	0.376	245.9	9.124	98.0	0.047	78.9	0.604	-38.8
700	0.360	235.9	7.856	92.7	0.054	79.7	0.573	-41.9
800	0.350	227.5	6.939	88.5	0.062	80.6	0.545	-44.5
900	0.342	220.8	6.231	84.9	0.069	81.0	0.526	-46.7
1000	0.333	214.6	5.620	81.6	0.077	81.4	0.504	-48.7
1200	0.322	204.2	4.714	76.0	0.092	82.0	0.481	-52.4
1400	0.318	195.8	4.071	71.3	0.109	82.3	0.469	-55.0
1600	0.312	188.4	3.591	67.0	0.125	82.2	0.466	-57.4
1800	0.308	181.5	3.219	62.9	0.143	82.0	0.463	-59.6
2000	0.307	175.0	2.925	59.1	0.162	81.6	0.463	-62.0
2200	0.304	168.7	2.690	55.4	0.181	81.0	0.469	-64.6
2400	0.306	163.5	2.501	51.7	0.202	80.0	0.475	-68.2
2600	0.302	157.8	2.327	48.3	0.222	79.1	0.477	-70.9
2800	0.305	153.6	2.202	45.2	0.245	78.2	0.488	-73.1
3000	0.317	149.2	2.101	41.4	0.271	76.3	0.508	-77.4

MCH3007

S Parameters (Common emitter)

$V_{CE}=5V, I_C=20mA$

Freq(MHz)	S11	$\angle S11$	S21	$\angle S21$	S12	$\angle S12$	S22	$\angle S22$
100	0.591	-37.1	19.539	151.2	0.010	86.0	0.904	-12.7
200	0.508	-64.2	15.394	132.6	0.017	73.2	0.808	-20.0
300	0.425	264.1	13.138	115.7	0.023	75.0	0.740	-23.8
400	0.396	246.9	10.561	106.1	0.028	77.4	0.696	-26.6
500	0.393	228.4	8.791	97.4	0.034	79.7	0.648	-30.4
600	0.393	219.4	7.452	92.2	0.041	81.8	0.625	-32.3
700	0.398	211.1	6.426	87.4	0.047	83.9	0.605	-35.1
800	0.400	204.4	5.644	83.5	0.054	85.1	0.586	-37.6
900	0.403	199.0	5.020	79.9	0.062	86.4	0.574	-39.9
1000	0.402	194.0	4.518	76.8	0.069	87.1	0.559	-42.2
1200	0.404	185.7	3.761	71.1	0.085	88.2	0.546	-46.5
1400	0.408	178.9	3.240	66.2	0.102	88.9	0.541	-49.9
1600	0.409	172.7	2.850	61.6	0.120	89.1	0.544	-53.4
1800	0.410	166.9	2.552	57.4	0.140	88.9	0.545	-56.7
2000	0.414	161.3	2.316	53.3	0.161	88.2	0.548	-60.1
2200	0.415	155.6	2.127	49.5	0.183	87.4	0.557	-63.7
2400	0.419	150.9	1.971	45.6	0.207	86.2	0.565	-68.1
2600	0.420	145.6	1.830	42.1	0.230	84.9	0.567	-71.8
2800	0.424	141.3	1.728	38.9	0.258	83.5	0.580	-74.8
3000	0.435	137.2	1.644	35.0	0.287	81.0	0.602	-79.9

$V_{CE}=8V, I_C=5mA$

Freq(MHz)	S11	$\angle S11$	S21	$\angle S21$	S12	$\angle S12$	S22	$\angle S22$
100	0.898	-11.4	9.031	164.6	0.014	81.3	0.979	-8.5
200	0.883	-17.3	8.611	152.5	0.023	80.9	0.951	-16.8
300	0.815	-31.0	8.301	143.8	0.034	78.7	0.903	-23.6
400	0.798	-36.5	7.927	137.3	0.044	76.2	0.858	-30.2
500	0.702	-53.6	7.625	126.6	0.054	72.7	0.790	-37.1
600	0.665	-62.3	6.978	120.2	0.062	71.9	0.744	-41.1
700	0.605	-73.7	6.732	112.7	0.069	70.5	0.697	-45.8
800	0.547	-83.4	6.322	106.0	0.076	69.6	0.654	-49.6
900	0.510	269.0	5.840	100.9	0.082	69.3	0.620	-52.9
1000	0.460	260.8	5.471	95.5	0.089	69.3	0.584	-55.5
1200	0.396	247.8	4.746	87.5	0.101	69.6	0.537	-60.0
1400	0.356	237.3	4.159	81.4	0.113	70.3	0.507	-62.8
1600	0.325	228.3	3.705	76.0	0.127	71.1	0.488	-65.1
1800	0.301	219.9	3.339	71.3	0.141	71.8	0.473	-66.8
2000	0.282	211.8	3.046	67.0	0.156	72.3	0.463	-68.7
2200	0.264	204.3	2.814	62.9	0.172	72.7	0.461	-70.6
2400	0.256	196.9	2.622	58.8	0.188	72.7	0.460	-73.5
2600	0.243	189.9	2.448	55.2	0.206	72.7	0.457	-75.5
2800	0.239	184.2	2.323	51.9	0.226	72.6	0.464	-76.9
3000	0.246	177.3	2.222	47.9	0.248	71.4	0.480	-80.5

MCH3007

S Parameters (Common emitter)

V_{CE}=8V, I_C=10mA

Freq(MHz)	S ₁₁	∠S ₁₁	S ₂₁	∠S ₂₁	S ₁₂	∠S ₁₂	S ₂₂	∠S ₂₂
100	0.804	-16.7	15.064	160.0	0.010	91.9	0.962	-10.7
200	0.769	-26.5	14.343	146.1	0.021	79.2	0.899	-20.5
300	0.657	-46.8	12.917	133.2	0.030	77.6	0.825	-27.2
400	0.617	-55.8	11.712	125.2	0.037	76.1	0.762	-32.7
500	0.500	-77.3	10.577	112.7	0.044	75.4	0.689	-38.6
600	0.461	-87.5	9.195	106.1	0.052	75.9	0.645	-41.6
700	0.416	260.9	8.345	99.5	0.059	76.1	0.605	-45.2
800	0.385	251.9	7.445	94.5	0.066	76.6	0.569	-48.2
900	0.363	244.1	6.716	90.3	0.073	77.0	0.543	-50.6
1000	0.340	237.2	6.084	86.7	0.080	77.1	0.516	-52.8
1200	0.310	225.3	5.122	80.6	0.095	77.7	0.482	-56.5
1400	0.293	215.4	4.430	75.5	0.111	78.0	0.462	-58.8
1600	0.278	206.9	3.909	71.1	0.126	78.2	0.453	-60.8
1800	0.267	198.9	3.505	66.9	0.143	78.1	0.445	-62.5
2000	0.259	191.3	3.187	63.1	0.160	77.9	0.441	-64.4
2200	0.250	184.2	2.932	59.4	0.178	77.5	0.445	-66.4
2400	0.248	177.9	2.724	55.7	0.197	76.8	0.447	-69.5
2600	0.241	171.4	2.536	52.4	0.215	76.1	0.448	-71.7
2800	0.242	166.8	2.402	49.3	0.237	75.4	0.458	-73.3
3000	0.253	161.3	2.293	45.6	0.260	73.9	0.476	-77.1

V_{CE}=8V, I_C=15mA

Freq(MHz)	S ₁₁	∠S ₁₁	S ₂₁	∠S ₂₁	S ₁₂	∠S ₁₂	S ₂₂	∠S ₂₂
100	0.714	-23.1	18.714	156.7	0.012	82.8	0.944	-12.2
200	0.657	-37.9	16.515	141.0	0.019	77.5	0.861	-21.6
300	0.531	-62.8	14.794	125.3	0.026	76.8	0.780	-27.3
400	0.473	-75.9	12.583	115.8	0.033	77.8	0.720	-31.6
500	0.401	264.1	10.957	105.3	0.040	78.3	0.652	-36.6
600	0.377	253.6	9.432	99.4	0.047	79.4	0.614	-39.0
700	0.356	243.3	8.297	94.0	0.054	80.2	0.582	-42.1
800	0.341	234.5	7.333	89.7	0.062	80.8	0.552	-44.8
900	0.331	227.5	6.576	86.0	0.069	81.2	0.531	-47.0
1000	0.319	221.1	5.934	82.8	0.076	81.5	0.508	-49.0
1200	0.305	210.1	4.973	77.2	0.092	81.9	0.483	-52.6
1400	0.298	201.2	4.291	72.5	0.108	82.1	0.469	-55.0
1600	0.290	193.5	3.781	68.2	0.125	82.1	0.465	-57.3
1800	0.285	186.3	3.387	64.2	0.142	81.8	0.461	-59.3
2000	0.282	179.4	3.078	60.4	0.160	81.4	0.460	-61.5
2200	0.278	172.9	2.829	56.8	0.179	80.7	0.466	-63.9
2400	0.279	167.4	2.628	53.1	0.199	79.8	0.471	-67.3
2600	0.275	161.5	2.445	49.8	0.219	79.0	0.472	-69.9
2800	0.277	157.3	2.313	46.8	0.242	78.1	0.484	-71.8
3000	0.289	152.7	2.208	43.0	0.267	76.2	0.504	-76.0

MCH3007

S Parameters (Common emitter)

$V_{CE}=8V$, $I_C=20mA$

Freq(MHz)	S11	$\angle S11$	S21	$\angle S21$	S12	$\angle S12$	S22	$\angle S22$
100	0.625	-31.7	20.496	153.2	0.010	85.3	0.924	-12.4
200	0.547	-54.4	16.242	135.3	0.018	74.6	0.832	-20.6
300	0.441	-82.8	14.433	118.7	0.023	75.1	0.757	-25.0
400	0.396	261.2	11.734	109.0	0.029	78.6	0.708	-28.2
500	0.371	241.9	9.955	100.1	0.035	80.3	0.652	-32.3
600	0.363	232.1	8.478	94.7	0.042	82.4	0.623	-34.3
700	0.360	222.8	7.373	89.9	0.049	83.6	0.599	-37.1
800	0.357	215.2	6.487	85.9	0.056	84.8	0.576	-39.6
900	0.356	209.3	5.797	82.4	0.064	85.5	0.561	-41.8
1000	0.352	203.5	5.218	79.3	0.071	86.0	0.543	-44.0
1200	0.350	194.2	4.357	73.7	0.087	86.8	0.525	-47.9
1400	0.350	186.7	3.757	69.0	0.103	87.1	0.518	-50.9
1600	0.349	180.0	3.309	64.6	0.121	87.1	0.518	-53.9
1800	0.348	173.7	2.964	60.5	0.140	86.8	0.517	-56.6
2000	0.350	167.7	2.691	56.6	0.159	86.3	0.519	-59.6
2200	0.349	161.7	2.472	52.9	0.180	85.5	0.527	-62.7
2400	0.352	156.9	2.295	49.1	0.202	84.4	0.534	-66.7
2600	0.351	151.4	2.132	45.7	0.224	83.2	0.536	-69.9
2800	0.354	147.2	2.016	42.6	0.250	82.1	0.549	-72.5
3000	0.367	143.1	1.922	38.7	0.277	79.9	0.570	-77.2

Taping Specification

MCH3007-TL-H

1. Packing Format

Package Name	Carrier Tape Type	Maximum Number of devices contained (pcs)			Packing format	
		Reel	Inner box	Outer box	Inner BOX (C-1)	Outer BOX (A-7)
MCPH3	MCPH3	3,000	15,000	90,000	5 reels contained Dimensions:mm (external) 183×72×185	6 inner boxes contained Dimensions:mm (external) 440×195×210

Reel label, Inner box label
(unit: mm)

Outer box label
It is a label at the time of factory shipments.
The form of a label may change in physical distribution process.

Packing method

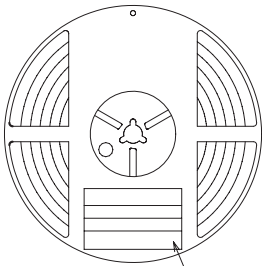

Type No.
LOT No.
Quantity
Origin

Reel label

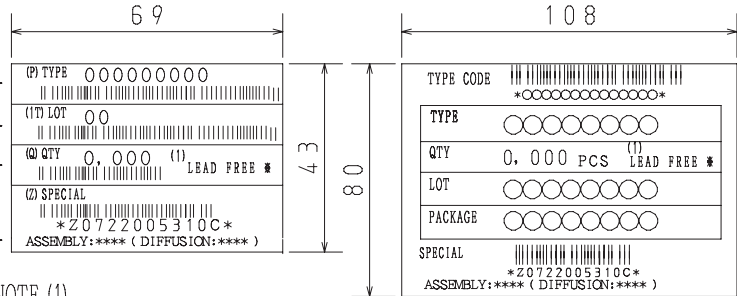

NOTE (1)

The LEAD FREE * description shows that the surface treatment of the terminal is lead free.

Label	JEITA Phase
LEAD FREE 3	JEITA Phase 3A
LEAD FREE 4	JEITA Phase 3

2. Taping configuration

2-1. Carrier tape size (unit:mm)

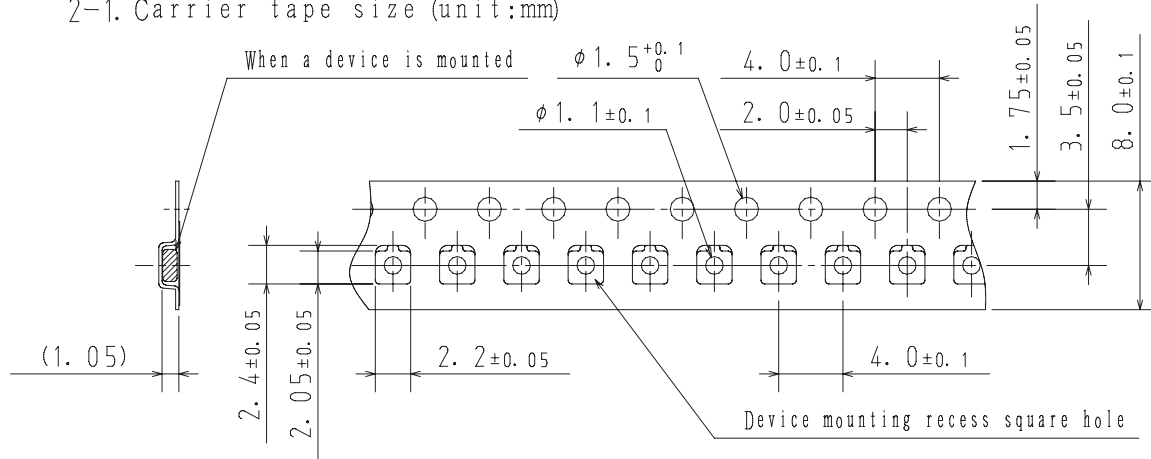

2-2. Device placement direction

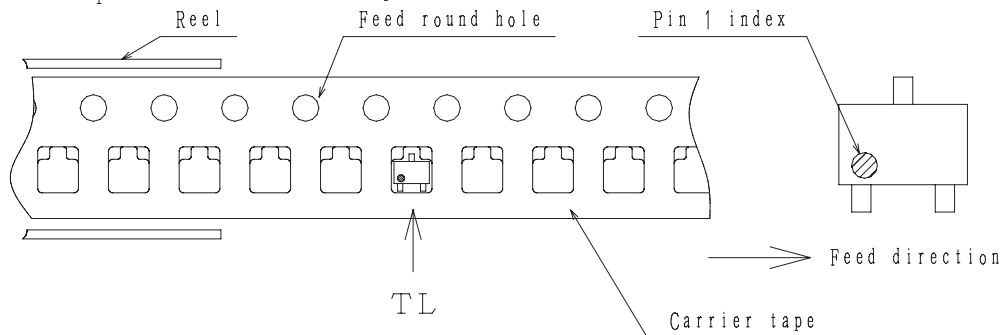

Those with pin 1 index on the feed hole side.....TL

MCH3007

Outline Drawing MCH3007-TL-H

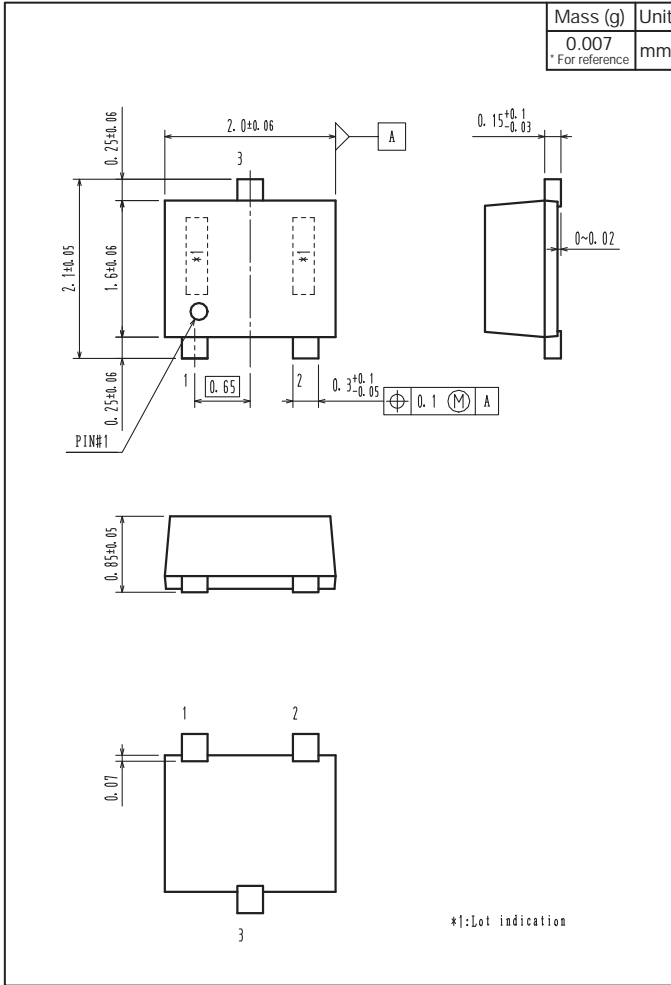

Land Pattern Example

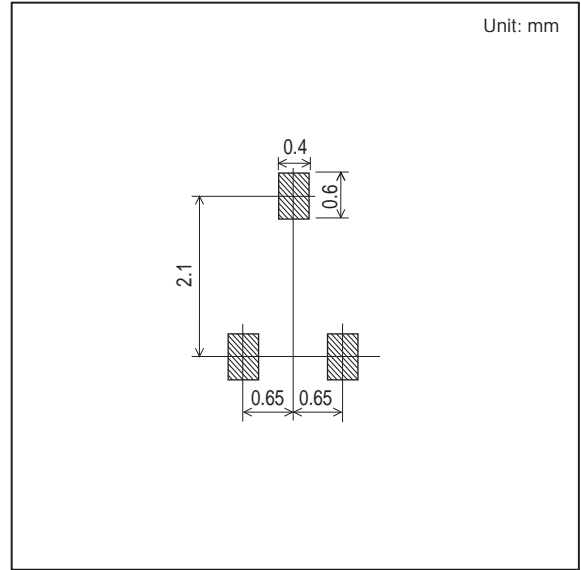

ON Semiconductor and the ON logo are registered trademarks of Semiconductor Components Industries, LLC (SCILLC). SCILLC owns the rights to a number of patents, trademarks, copyrights, trade secrets, and other intellectual property. A listing of SCILLC's product/patent coverage may be accessed at www.onsemi.com/site/pdf/Patent-Marking.pdf. SCILLC reserves the right to make changes without further notice to any products herein. SCILLC makes no warranty, representation or guarantee regarding the suitability of its products for any particular purpose, nor does SCILLC assume any liability arising out of the application or use of any product or circuit, and specifically disclaims any and all liability, including without limitation special, consequential or incidental damages. "Typical" parameters which may be provided in SCILLC data sheets and/or specifications can and do vary in different applications and actual performance may vary over time. All operating parameters, including "Typicals" must be validated for each customer application by customer's technical experts. SCILLC does not convey any license under its patent rights nor the rights of others. SCILLC products are not designed, intended, or authorized for use as components in systems intended for surgical implant into the body, or other applications intended to support or sustain life, or for any other application in which the failure of the SCILLC product could create a situation where personal injury or death may occur. Should Buyer purchase or use SCILLC products for any such unintended or unauthorized application, Buyer shall indemnify and hold SCILLC and its officers, employees, subsidiaries, affiliates, and distributors harmless against all claims, costs, damages, and expenses, and reasonable attorney fees arising out of, directly or indirectly, any claim of personal injury or death associated with such unintended or unauthorized use, even if such claim alleges that SCILLC was negligent regarding the design or manufacture of the part. SCILLC is an Equal Opportunity/Affirmative Action Employer. This literature is subject to all applicable copyright laws and is not for resale in any manner.