



# MEAX-LGG-AM

CELLULAR/LTE and GPS/GLONASS Adhesive  
Part #: 100-00163-01

## Description

Maxtena's MEA-LGG-AM GPS/GLONASS & LTE solution is a high performance antenna in one compact and secure housing. It covers GPS/GLONASS (1575-1606 MHz) and LTE (698-960/ 1710-2170/ 2500-2700 MHz). The antenna provides exceptional pattern control, polarization purity and high efficiency. The MEA-LGG-AM is an adhesive mount antenna with rugged ABC plastic housing and is ideal for the most demanding environment challenges. It is ideal for glass mount applications. The standard MEA-LGG-AM comes with 3 meters LMR100 cable and SMA-Male connectors for both GPS/GLONASS cables. Cable and connectors are customizable upon request. The MEA-LGG-AM provides outstanding performance for any telematics, remote monitoring, and fleet management application.

**Cable 1:**

Parameter	Specification
Technology	4G, 3G and 2G
Frequency Range	698-960 MHz
Band	700/850/900 MHz
Return Loss	-12.1 dB
VSWR	1.7:1
Efficiency	76%
Peak Gain	3.4 dBi
Average Gain	-1.2 dB
Frequency Range	1710-2170 MHz
Band	1700/1800/1900/2100 MHz
Return Loss	-16.5 dB
VSWR	1.4:1
Efficiency	69%
Peak Gain	3.5 dBi
Average Gain	-1.6 dB
Frequency Range	2500-2700 MHz
Band	2600 MHz
Return Loss	-14.8 dB
VSWR	1.5:1
Efficiency	76%
Peak Gain	3.9 dBi
Average Gain	-1.18 dB
Impedance	50 Ohm
Polarization	Linear
Radiation Pattern	Omni-Directional
Max. Input Power	25 W

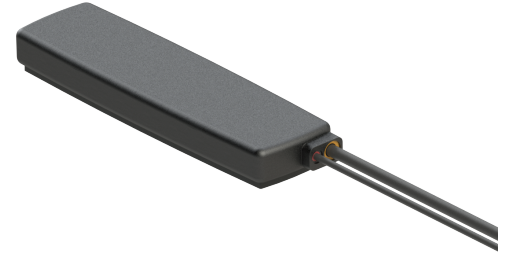

## Features

- 2in 1 antenna (CELLULAR/LTE, GPS/GLONASS/QZSS/Galileo)
- Adhesive Mount
- High Performance
- Ground Plane Independent
- Customizable Cable and Connector
- Dimensions 150.5 x 42 x 15.3 mm
- IP67, IP69

## Applications

- Fleet management
- Telematics
- Monitoring
- IOT
- Asset tracking
- Security and Surveillance
- Vending Machines

**Cable 2:**

Parameter	Specification	
Frequency Range	1575.42 MHz	1598-1606 MHz
Band	1575 MHz	1602 MHz
Return Loss	≤ -15 dB	
VSWR	≤ 1.4:1	
Impedance	50 Ω	
Radiation Pattern	Hemispherical	
Polarization	RHCP	
Active Gain	28 dB @ 2.7 V	
Noise Figure	1.5 dB Typ	
Voltage	1.5 – 3.6 V	
Current Consumption	9 mA Typ	
Power Consumption	24.3 mW Typ	
ESD Protection	2kV	
Saw Filter	pre-filter	

**Mechanical Specification**

Parameter	Specification
Antenna Dimensions	150.5 x 42 x 15.3 mm
Operating Temperature	-40°C to 85°C
Connector Type	SMA-Male Standard
Mounting Type	Adhesive Mount
Radome	ABS
Radome color	Black
Substance Compliance	RoHS
Certificates	IP67, IP69

\*Mounted on 30 x 30 x 0.25 cm ABS Plate

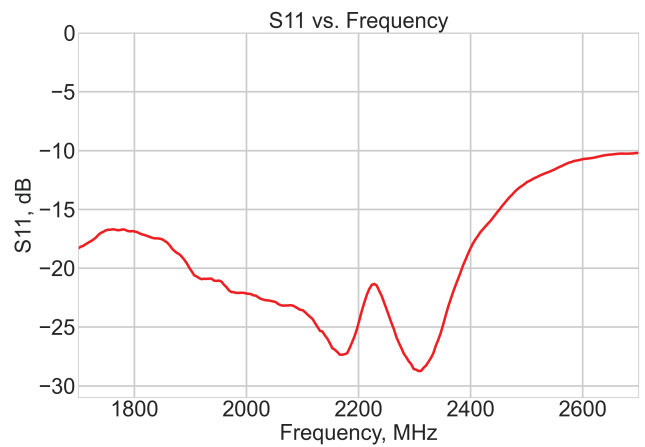
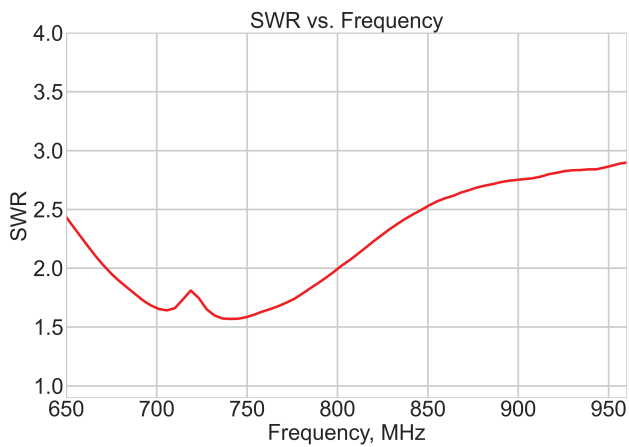
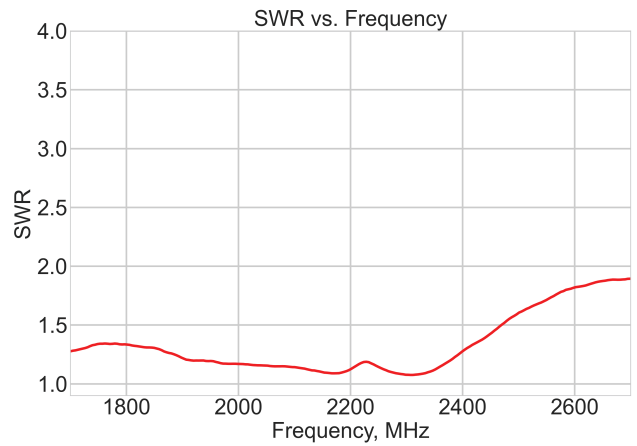
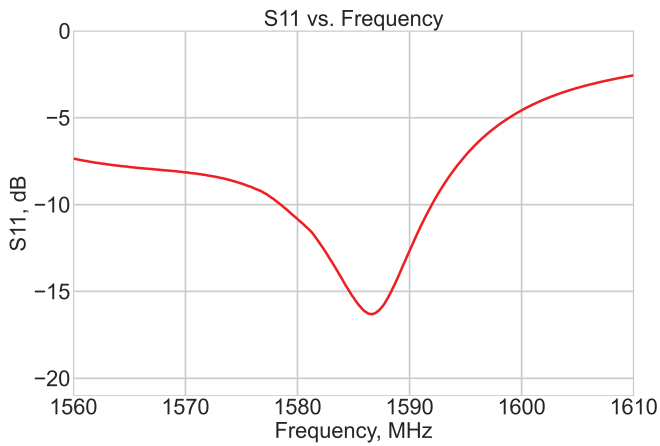
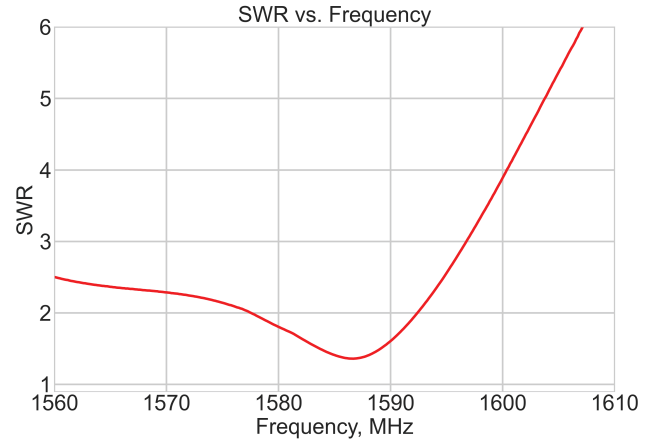
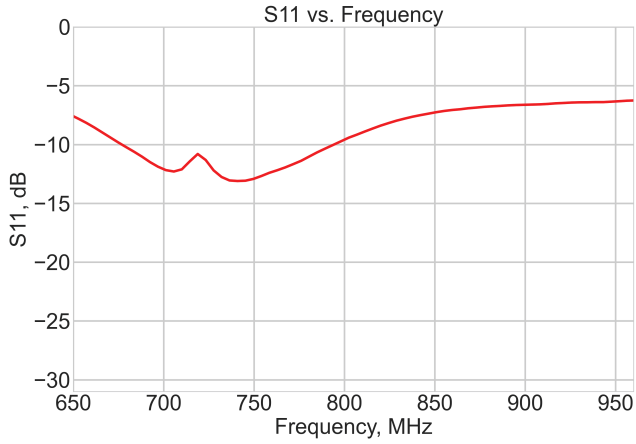

DRAWING REVISION HISTORY			
REV	DESCRIPTION	DATE	BY
A	INITIAL RELEASE	2021-06-17	SZ

NOTES:

1. FREQUENCY:
  - CABLE1 (CELLULAR/LTE): 698-960 MHz; 1710-2170 MHz; 2500-2700 MHz
  - CABLE2 (GPS/GLONASS/QZSS/GALILEO): 1563-1608 MHz
2. CUSTOMIZABLE CABLE AND CONNECTOR TYPE
3. MECHANICAL:
  - MOUNTING TYPE: ADHESIVE MOUNT
  - RADOME MATERIAL, COLOR: ABS UV STABLE, BLACK
  - OPERATING TEMPERATURE: -40 °C ~ 85 °C
  - STORAGE TEMPERATURE: -40 °C ~ 85 °C
  - CERTIFICATES: IP67, IP69

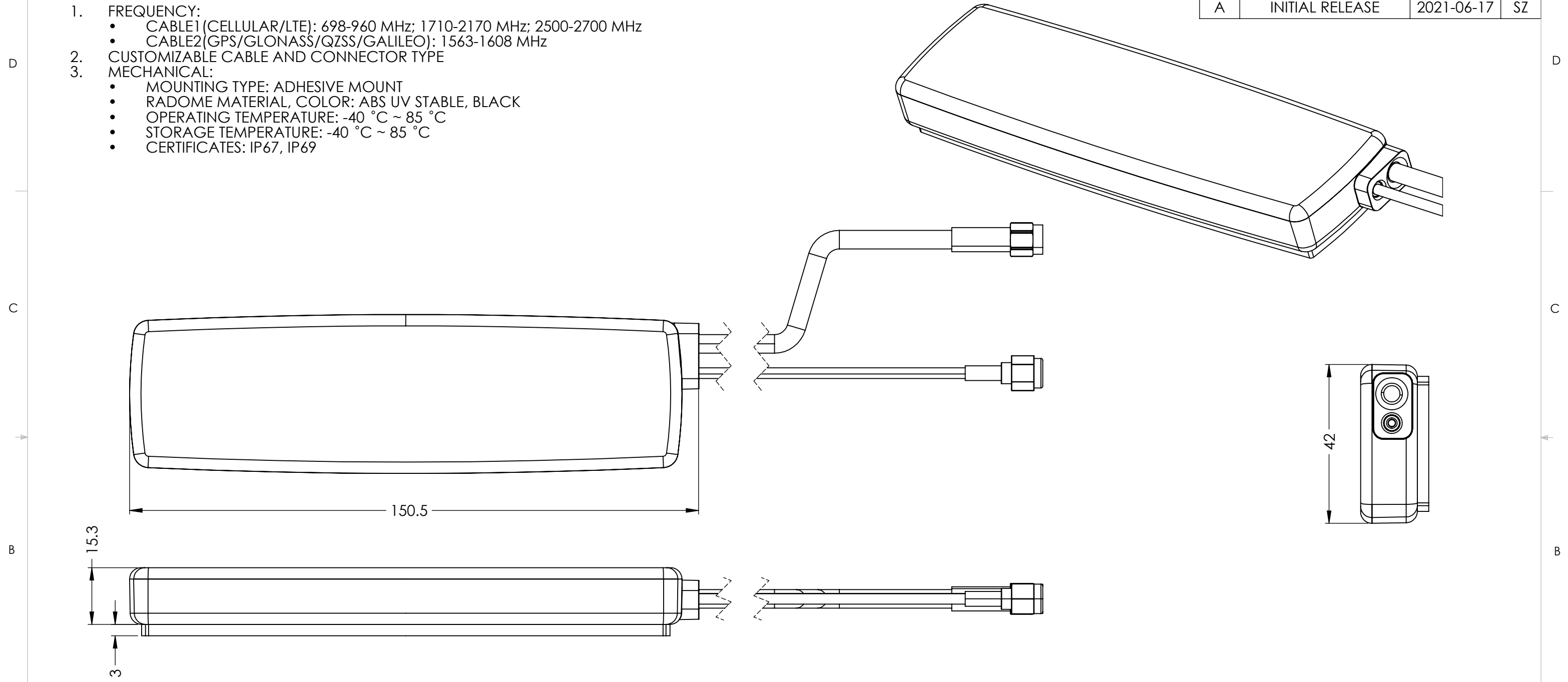

ITEM 100-00163 REVISION HISTORY			
REV	DESCRIPTION	DATE	BY
A	INITIAL RELEASE	2021-06-17	SZ

100-00163 CONFIGURATION TABLE			
DASH NO	CABLE TYPE	CABLE LENGTH	CONNECTOR TYPE
-01	CABLE 1: LMR195 CABLE 2: LMR100	300 cm 300 cm	SMA-MALE SMA-MALE

UNLESS OTHERWISE SPECIFIED:  
 DIMENSIONS ARE IN MM  
 TOLERANCES:  
 FRACTIONAL ±  
 ANGULAR: MACH ± .5° BEND ±  
 INTEGER ± 1.0  
 ONE PLACE DECIMAL ± 1.0  
 TWO PLACE DECIMAL ± .50  
 INTERPRET GEOMETRIC TOLERANCING PER:

	NAME	DATE
DRAWN	SZ	2021-06-17
CHECKED	ZX	2021-06-17
ENG APPR.	NPC	2021-06-17
MFG APPR.		
Q.A.		

THIRD ANGLE PROJECTION  
DO NOT SCALE DRAWING

CAD MAINTAINED. CHANGES SHALL BE INCORPORATED BY THE DESIGN ACTIVITY.

MAXTENA, INC

TITLE: 100-00163 MEA-LGG-AM

SIZE B DWG. NO. 117-00419-01 REV A

CAGE CODE: 5KQH7 SCALE: NONE SHEET 1 OF 1