

## FEATURES

- Collector Current: ( $I_C = 1.5A$ )
- Complementary To SS8550.
- Collector Power Dissipation:  $P_C = 2W (T_C = 25^\circ C)$

## APPLICATIONS

- High Collector Current.

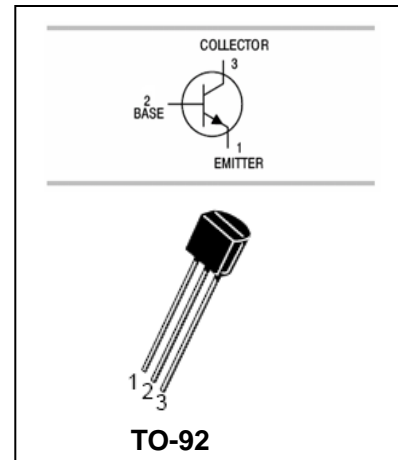

## MAXIMUM RATING @ $T_a = 25^\circ C$ unless otherwise specified

Symbol	Parameter	Ratings	Units
$V_{CBO}$	Collector-Base Voltage	40	V
$V_{CEO}$	Collector-Emitter Voltage	25	V
$V_{EBO}$	Emitter-Base Voltage	6	V
$I_C$	Collector Current -Continuous	1.5	A
$P_C$	Collector Dissipation	1	W
$T_j$	Junction Temperature	150	$^\circ C$
$T_{stg}$	Storage Temperature	-65 to +150	$^\circ C$

**ELECTRICAL CHARACTERISTICS @ Ta=25°C unless otherwise specified**

Parameter	Symbol	Test conditions	MIN	TYP	MAX	UNIT
Collector-base breakdown voltage	$V_{(BR)CBO}$	$I_C=100\mu A, I_E=0$	40	-	-	V
Collector-emitter breakdown voltage	$V_{(BR)CEO}$	$I_C=2mA, I_B=0$	25	-	-	V
Emitter-base breakdown voltage	$V_{(BR)EBO}$	$I_E=100\mu A, I_C=0$	6	-	-	V
Collector cut-off current	$I_{CBO}$	$V_{CB}=35V, I_E=0$	-	-	0.1	$\mu A$
Collector cut-off current	$I_{CEO}$	$V_{CE}=20V, I_B=0$	-	-	0.1	$\mu A$
Emitter cut-off current	$I_{EBO}$	$V_{EB}=6V, I_C=0$	-	-	0.1	$\mu A$
DC current gain	$h_{FE}$	$V_{CE}=1V, I_C=5mA$	45	135	300	-
		$V_{CE}=1V, I_C=100mA$	85	160		-
		$V_{CE}=1V, I_C=800mA$	40	110		-
Collector-emitter saturation voltage	$V_{CE(sat)}$	$I_C=800mA, I_B=80mA$	-	0.28	0.5	V
Base-emitter saturation voltage	$V_{BE(sat)}$	$I_C=800mA, I_B=80mA$	-	0.98	1.2	V
Base-emitter voltage	$V_{BE}$	$V_{CE}=1V, I_C=10mA$	-	0.66	1	V
Output capacitance	$C_{ob}$	$V_{CB}=10V, I_E=0$ $f=1MHz$	-	9.0	-	pF
Transition frequency	$f_T$	$V_{CE}=10V, I_C=50mA$	100	190	-	MHz

 **$h_{FE}$  CLASSIFICATION**

Classification	B	C	D
h	85-160	120-200	160-300

TYPICAL CHARACTERISTICS @ Ta=25°C unless otherwise specified

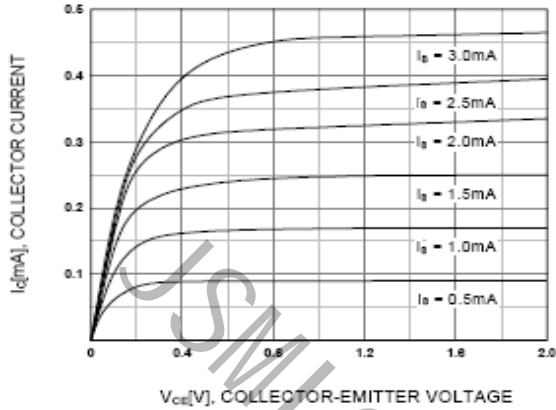

Figure 1. Static Characteristic

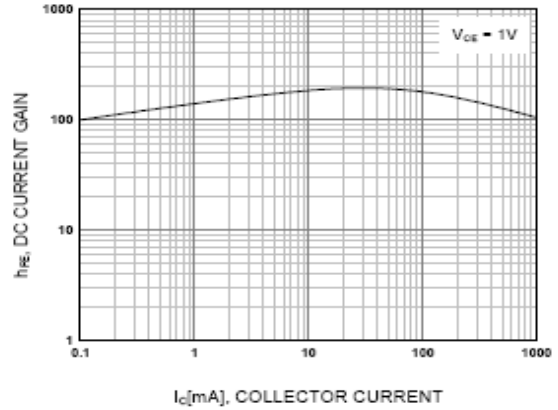

Figure 2. DC current Gain

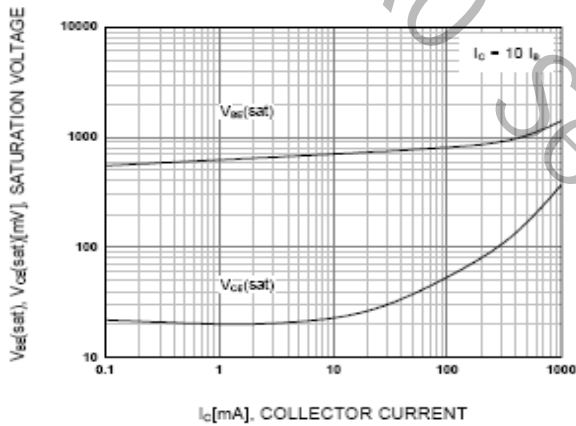

Figure 3. Base-Emitter Saturation Voltage  
Collector-Emitter Saturation Voltage

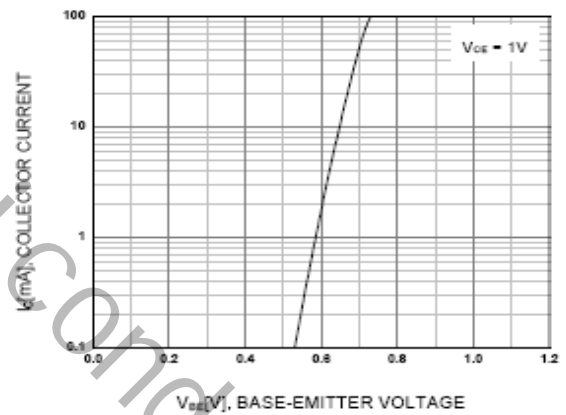

Figure 4. Base-Emitter On Voltage

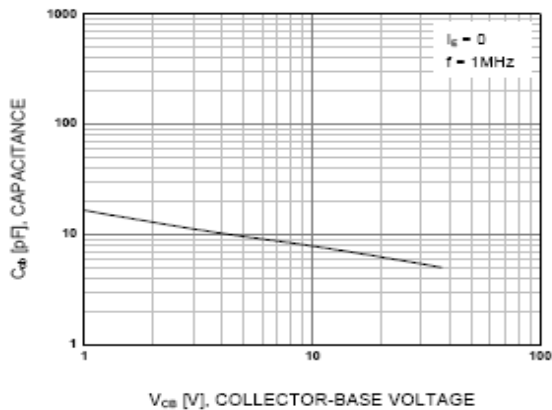

Figure 5. Collector Output Capacitance

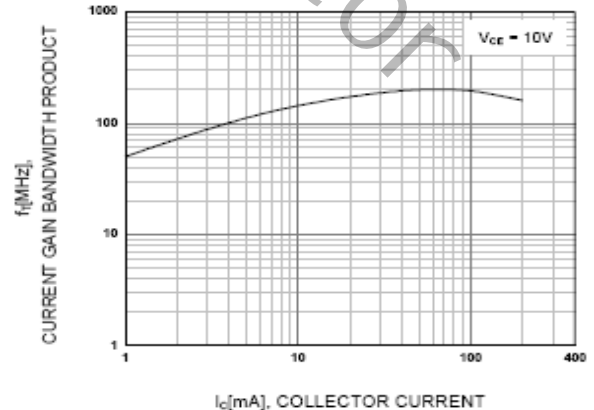

Figure 6. Current Gain Bandwidth Product

**PACKAGE OUTLINE**

Plastic surface mounted package

TO-92

