

# MHI300ARW18 Series

## Wide Input, 3W DIP Ultra-High Isolation DC/DC Converters



### Key Features:

- 3W Output Power
- 8.0 kV Isolation
- 15 kV/ $\mu$ S CMTI
- Wide 2:1 Input Range
- Reinforced Insulation
- EN 60950 Approved (Pend.)
- -40°C to +85°C Operation
- Industry Standard Pin-Out



### Electrical Specifications

Specifications typical @ +25°C, nominal input voltage & rated output current, unless otherwise noted. Specifications subject to change without notice.

Input						
Parameter	Conditions	Min.	Typ.	Max.	Units	
Input Voltage Range	5 VDC Input	4.5	5.0	5.5	VDC	
	12 VDC Input	9.0	12.0	18.0		
	24 VDC Input	18.0	24.0	36.0		
	48 VDC Input	36.0	48.0	75.0		
Start-Up Threshold Voltage	5 VDC Input	3.7	4.0	4.5	VDC	
	12 VDC Input	8.0	8.5	9.0		
	24 VDC Input	15.0	17.0	18.0		
	48 VDC Input	30.0	33.0	36.0		
Under Voltage Shutdown	5 VDC Input			4.0	VDC	
	12 VDC Input			8.5		
	24 VDC Input			17.0		
	48 VDC Input			34.0		
Short Circuit Input Power				2,000	mW	
Input Filter	$\pi$ (Pi) Filter					
Conducted EMI	Meets EN 55022 Class A & FCC Level A					

Output						
Parameter	Conditions	Min.	Typ.	Max.	Units	
Output Voltage Accuracy				$\pm 1.0$	%	
Output Voltage Balance	Dual Output, Balanced Loads		$\pm 0.5$	$\pm 2.0$	%	
Line Regulation	$V_{IN} = \text{Min to Max}$		$\pm 0.3$	$\pm 0.5$	%	
Load Regulation	See Note 2		$\pm 0.5$	$\pm 1.0$	%	
Ripple & Noise (20 MHz) <sup>&lt;</sup> See Note 3	5 VDC Output Models		75	100	mV P - P	
	All Other Models		100	150		
Transient Recovery Time, See Note 4	25% Load Step Change		150	500	$\mu$ Sec	
Transient Response Deviation			$\pm 3.0$	$\pm 6.0$	%	
Output Power Protection	Foldback	120	150		%	
Temperature Coefficient			$\pm 0.01$	$\pm 0.02$	%/°C	
Output Short Circuit	Continuous (Autorecovery)					

General						
Parameter	Conditions	Min.	Typ.	Max.	Units	
Isolation Voltage, 60 Sec	Rated For 60 Sec	4,000			VAC rms	
	Tested For 1 Sec	8,000			VDC	
Isolation Resistance	500 VDC	10			$G\Omega$	
Isolation Capacitance	100 kHz, 1V		7	13	pF	
Common Mode Transient Immunity		15			kV/ $\mu$ S	
Switching Frequency			150		kHz	

Environmental						
Parameter	Conditions	Min.	Typ.	Max.	Units	
Operating Temperature Range	Ambient	-40	+25	+85	°C	
	Case			+100		
Storage Temperature Range		-50		+125	°C	
Cooling	Free Air Convection					
Humidity	RH, Non-condensing			95	%	

Physical						
Case Size	See Mechanical Diagram (Page 3)					
Case Material	Non-Conductive Black Plastic (UL94-V0)					
Weight	0.54 Oz (16.2g)					

Reliability Specifications						
Parameter	Conditions	Min.	Typ.	Max.	Units	
MTBF	MIL HDBK 217F, 25°C, Gnd Benign	1.0			MHours	
Safety Standards	UL 60950, EN 60950 (Pending)					

Absolute Maximum Ratings						
Parameter	Conditions	Min.	Typ.	Max.	Units	
Input Voltage Surge (0.1 Sec)	5 VDC Input			11.0	VDC	
	12 VDC Input			25.0		
	24 VDC Input			50.0		
	48 VDC Input			100.0		
Lead Temperature	1.5 mm From Case for 10 Sec			260	°C	

Caution: Exceeding Absolute Maximum Ratings may damage the module. These are not continuous operating ratings.

### MicroPower Direct

292 Page Street  
Suite D  
Stoughton, MA 02072  
USA

T: (781) 344-8226  
F: (781) 344-8481  
E: sales@micropowerelect.com  
W: www.micropowerelect.com



Model Number	Input				Output			Efficiency (% Typ)	Capacitive Load (µF, Max)	Fuse Rating Slow-Blow (mA)
	Voltage (VDC)		Current (mA)		Voltage (VDC)	Current (mA, Max)	Current (mA, Min)			
	Nominal	Range	Full-Load	No-Load						
MHI305S-05ARW18	5	4.5 - 9.0	870	40	5.0	600	90.0	69	1,000	2,000
MHI305S-12ARW18	5	4.5 - 9.0	811	40	12.0	250	37.5	74	470	2,000
MHI305S-24ARW18	5	4.5 - 9.0	800	40	24.0	125	18.8	76	470	2,000
MHI305D-12ARW18	5	4.5 - 9.0	800	40	±12.0	±125	±18.8	75	220	2,000
MHI305D-15ARW18	5	4.5 - 9.0	800	40	±15.0	±100	±15.0	75	220	2,000
MHI312S-05ARW18	12	9.0 - 18.0	342	30	5.0	600	90.0	73	1,000	750
MHI312S-12ARW18	12	9.0 - 18.0	316	30	12.0	250	37.5	79	470	750
MHI312S-24ARW18	12	9.0 - 18.0	313	30	24.0	125	18.8	81	470	750
MHI312D-12ARW18	12	9.0 - 18.0	313	30	±12.0	±125	±18.8	80	220	570
MHI312D-15ARW18	12	9.0 - 18.0	313	30	±15.0	±100	±15.0	80	220	750
MHI324S-05ARW18	24	18.0 - 36.0	162	20	5.0	600	90.0	77	1,000	300
MHI324S-12ARW18	24	18.0 - 36.0	152	20	12.0	250	37.5	82	470	300
MHI324S-24ARW18	24	18.0 - 36.0	151	20	24.0	125	18.8	84	470	300
MHI324D-12ARW18	24	18.0 - 36.0	151	20	±12.0	±125	±18.8	83	220	300
MHI324D-15ARW18	24	18.0 - 36.0	151	20	±15.0	±100	±15.0	83	220	300
MHI348S-05ARW18	48	36.0 - 75.0	81	10	5.0	600	90.0	77	1,000	200
MHI348S-12ARW18	48	36.0 - 75.0	76	10	12.0	250	37.5	82	470	200
MHI348S-24ARW18	48	36.0 - 75.0	75	10	24.0	125	18.8	84	470	200
MHI348D-12ARW18	48	36.0 - 75.0	75	10	±12.0	±125	±18.8	83	220	200
MHI348D-15ARW18	48	36.0 - 75.0	75	10	±15.0	±100	±15.0	83	220	200

Notes:

1. The specified maximum capacitive load is for each output.
2. Load regulation is measured over a range of 25% load to 100% load.
3. When measuring output ripple & noise, it is recommended that an external capacitor (0.47 µF typ.) be placed from the +Vout to the -Vout pins for single output units and from each output to common for dual output models. To further reduce output ripple, a 3.3 µF is recommended.
4. Transient recovery is measured to within a 1% error band for a load step change of 75% to 100%.
5. The converter should be connected to a low ac-impedance source. A source with a highly inductive impedance may affect the stability of the converter. In applications where the converter output loading is high and input power is supplied over long lines, it may be necessary to use a capacitor on the input to insure start-up. In this case, it is recommended that a low ESR (<1.0Ω at 100 kHz) capacitor be mounted close to the converter. For 5V input units a 10.0 µF is recommended; for 12V input units, a 4.7 µF; and for 24V & 48V units a 2.2 µF.
6. Operation at no-load will not damage the unit, but they may not meet all specifications.
7. It is recommended that a fuse be used on the input of a power supply for protection. See the Model Selection tables for the correct rating.

Derating Curve

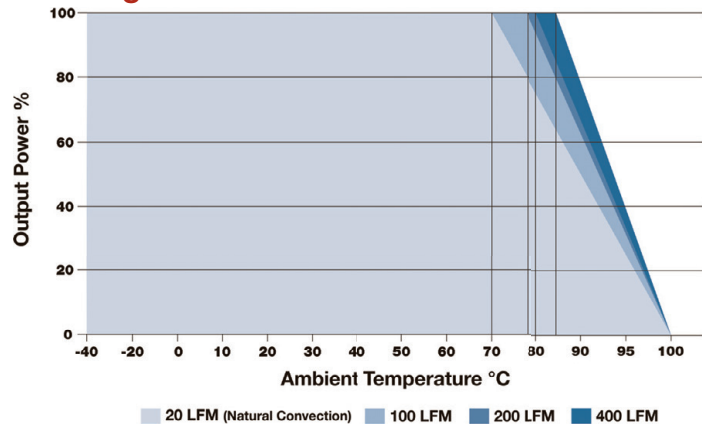

IGBT Applications

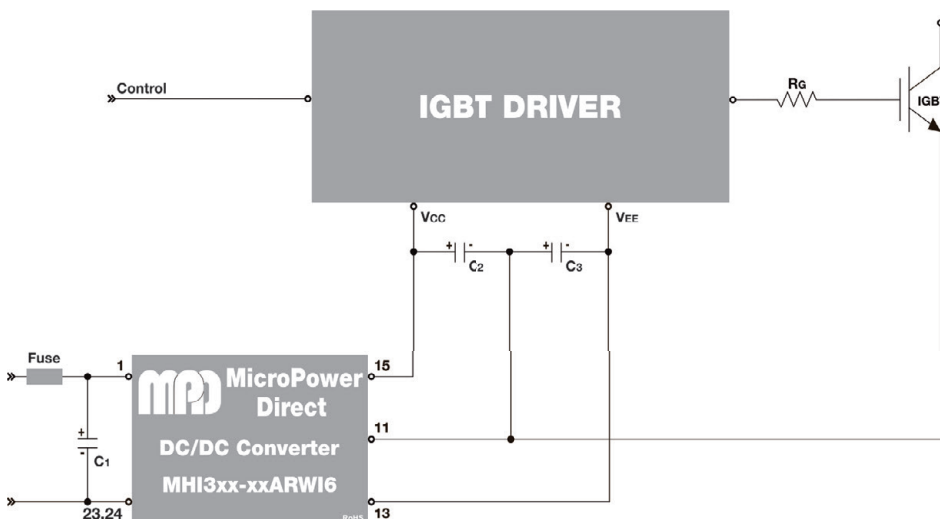

Notes:

The MHI300x-xxARW series is a good choice for applications involving high speed switching, such as driving IGBTs. They are designed to withstand the extra stress caused by the high voltage switching transients present in IGBT drive circuits.

All of the MHIxxx series have isolation levels that range from 5.2 to 8 kV. Many of these have reinforced insulation. The high isolation levels (and the correspondingly low capacitive coupling rates) allow them to be safely used in applications with highly dynamic switched AC or DC.

**Mechanical Dimensions**

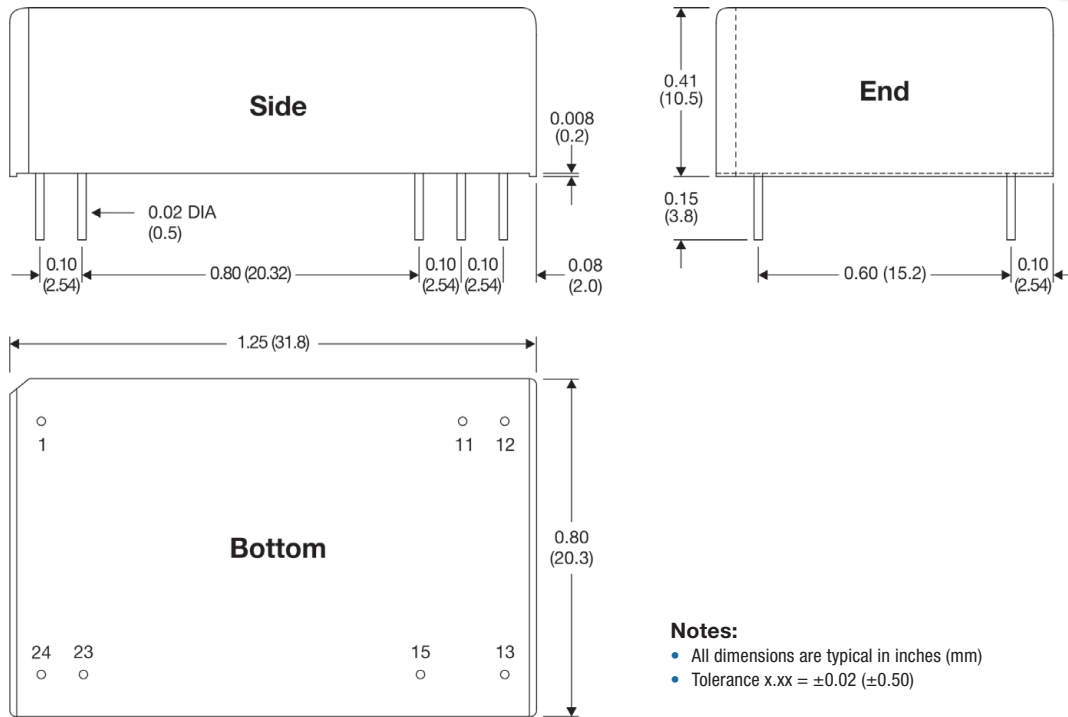

**Pin Connections**











Pin	Single Output
1	+VIN
11	No Pin
12	-VOUT
13	+VOUT
15	No Pin
23	-VIN
24	-VIN

Pin	Dual Output
1	+VIN
11	Common
12	No Pin
13	-VOUT
15	+VOUT
23	-VIN
24	-VIN

**Notes:**

- All dimensions are typical in inches (mm)
- Tolerance x.xx = ±0.02 (±0.50)

**MHI Products:** MPD offers a wide range products well suited for applications requiring high isolation levels & high transient immunity.

Product Family	Power	Input Range	Inputs (vdc)	Isolation	CMTI	Outputs (vdc)	EN 60950	Package
MHI100DI5.7 	1W	±10%	5, 12, 15, 24	60S - 5,200 VDC 1S - 5,700 VDC	15 kV/μS	3.3, 5, 9, 12, 15 ±5, ±9, ±12, ±15, +15/-9	---	7 Pin-SIP
MHI200DI5.7 	2W	±10%	5, 12, 15, 24	60S - 5,200 VDC 1S - 5,700 VDC	15 kV/μS	3.3, 5, 9, 12, 15 ±5, ±9, ±12, ±15, +15/-9	---	7 Pin-SIP
MHI200GRI8 	2W	±10%	5, 12, 24	60S - 4,000 VAC rms 1S - 8,000 VDC	15 kV/μS	5, 12, 15 ±12, ±15	Yes	MiniDIP
MHI200LRI8 	2W	±10%	5, 12, 24	60S - 4,000 VAC rms 1S - 8,000 VDC	15 kV/μS	5, 12, 15 ±12, ±15	Yes	SMT
MHI300ARI6 	3W	±10%	5, 12, 24	60S - 3,000 VAC rms 1S - 6,000 VDC	15 kV/μS	5, 12, 15 ±12, ±15	Yes	DIP
MHI300ARW8 	3W	2:1	5, 12, 24, 48	60S - 4,000 VAC rms 1S - 8,000 VDC	15 kV/μS	5, 12, 24 ±12, ±15	Yes	DIP
MHI300ARUI8 	3W	4:1	24, 48	60S - 4,000 VAC rms 1S - 8,000 VDC	15 kV/μS	5, 12 ±12, ±15	Yes	DIP
MHI600ARW8 	6W	2:1	12, 24, 48	60S - 4,000 VAC rms 1S - 8,000 VDC	15 kV/μS	5, 12 ±12, ±15	Yes	DIP
MHI1000BRW8 	10W	2:1	12, 24, 48	60S - 4,000 VAC rms 1S - 8,000 VDC	15 kV/μS	5, 5.1, 12 ±12, ±15	Yes	1" x 2"
MHI1500BRW8 	15W	2:1	12, 24, 48	60S - 4,200 VAC rms 1S - 8,000 VDC	15 kV/μS	5, 5.1, 12 ±12, ±15	Yes	1" x 2"
MHI2000BRW8 	20W	2:1	12, 24, 48	60S - 4,200 VAC rms 1S - 8,000 VDC	15 kV/μS	5, 5.1, 12 ±12, ±15	Yes	1" x 2"