

pui
audio™ inc
a projects unlimited company

SMS-1508MS-2-R SMD Speaker

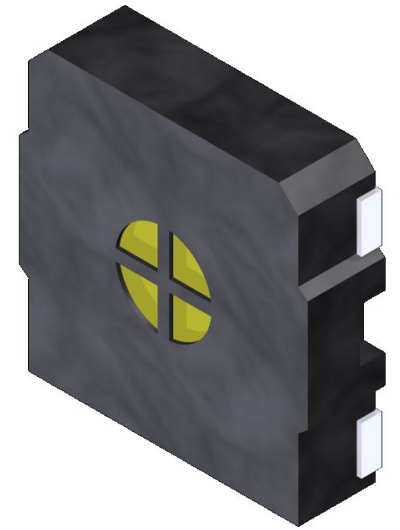

3541 Stop Eight Road • Dayton, Ohio 45414

Product Overview

- 15mm square micro dynamic surface mount speaker with 87 dB sensitivity
- 0.5W continuous, 0.8W maximum power handling and 8Ω impedance
- Kapton® cone for wide frequency response and LCP housing for reflow soldering

Frequency Response (0.5W @ 0.1 meter)

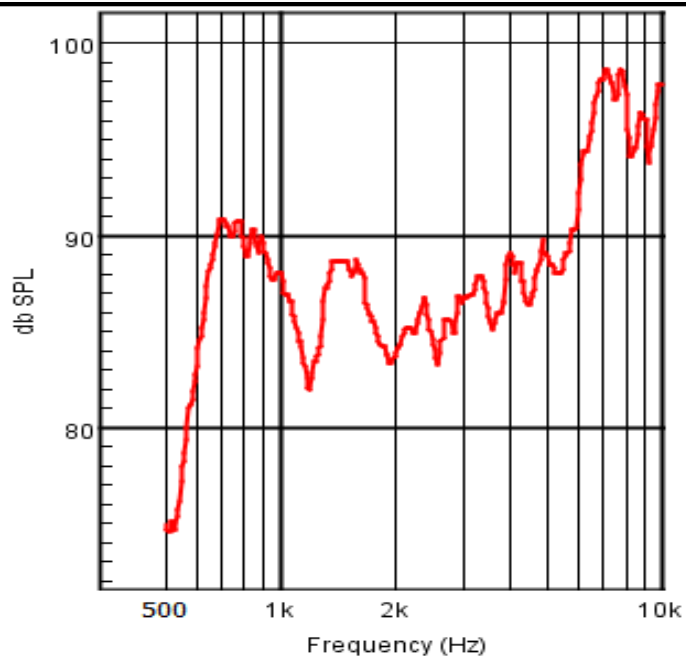

An Institute of the EICC and GeSI



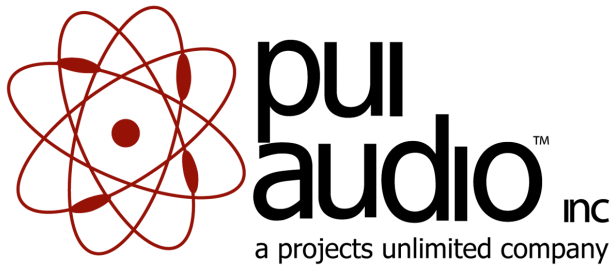

SMS-1508MS-2-R SMD Speaker

Mechanical and Environment Testing	
Test Description	Test Condition
High Temperature	85°C with random humidity for 96 hours
Low Temperature	-40°C with random humidity for 96 hours
Humidity	25°C to 65°C with 90% to 95% relative humidity for 96 hours
Vibration	5G movement modulated at 10 to 55 Hz for 2 hours each axis, 6 hours total
Drop Test	75 cm free fall onto 40 mm thick board, 10 cy-
Temperature Cycle Test	-40°C to 85°C, 5 cycles

After tests, speaker shall rest for 1 hours. SPL shall not deviate ± 3 dB from pre-test measurement.

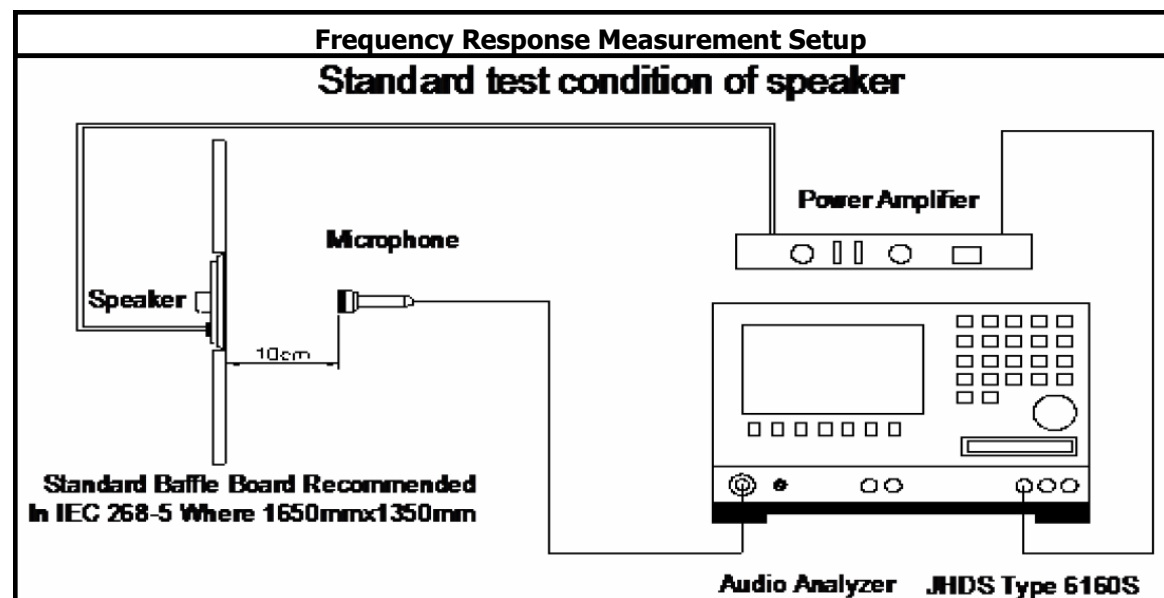
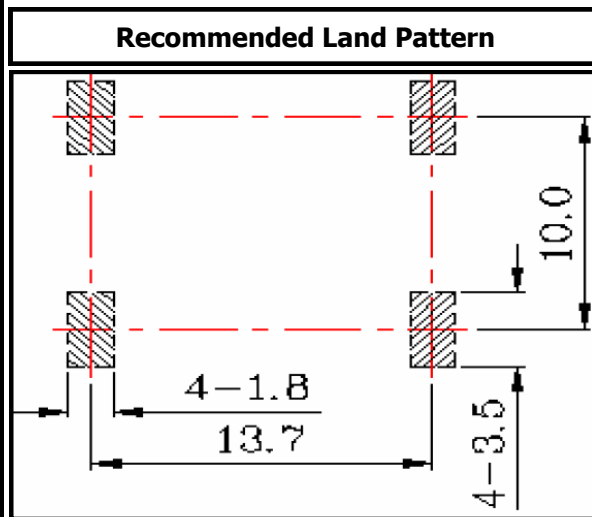
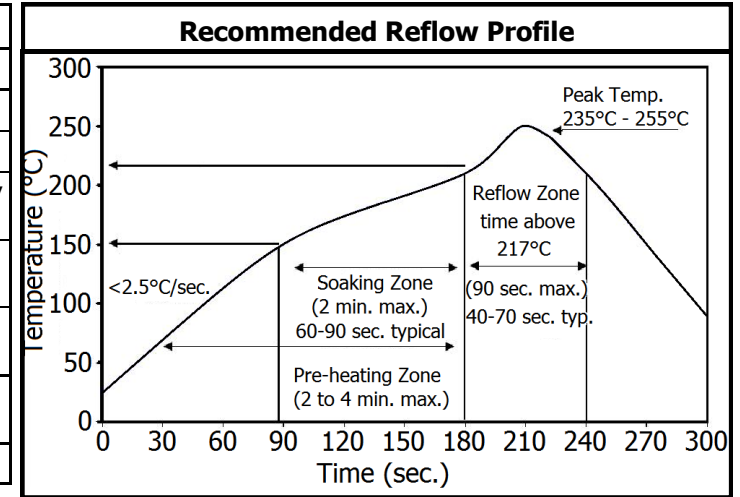

SPECIFICATIONS

PARAMETERS	VALUES	UNITS
RATED INPUT POWER	0.5	W
MAX INPUT POWER	0.8	W
IMPEDANCE	8 ± 15%	OHM
OUTPUT SPL @ 0.5W/0.1M (AT 1.0, 1.6, 2.0, 3.2 kHz)	87 ± 3	dBA
DISTORTION (MAX.)	5%	-
RESONANT FREQUENCY	800 ± 20%	Hz
FREQUENCY RANGE	500 ~ 10,000	Hz
HOUSING MATERIAL	LCP	-
CONE MATERIAL	KAPTON	-
MAGNET MATERIAL	SmCo	-
OPERATING TEMPERATURE	-30 ~ +85	°C
WEIGHT	1.5	grams

THIS DOCUMENT CONTAINS DATA PROPRIETARY TO PROJECTS UNLIMITED, INC. ANY USE OR REPRODUCTION, IN ANY FORM, WITHOUT PRIOR WRITTEN PERMISSION OF PROJECTS UNLIMITED, INC. IS PROHIBITED.
©2003, Projects Unlimited Inc.

REVISION HISTORY

LTR	DESCRIPTION	DATE	APPROVED
-	RELEASED FROM ENGINEERING	8/9/2011	
A	REVISED FREQUENCY RANGE	4/27/2012	B.R.

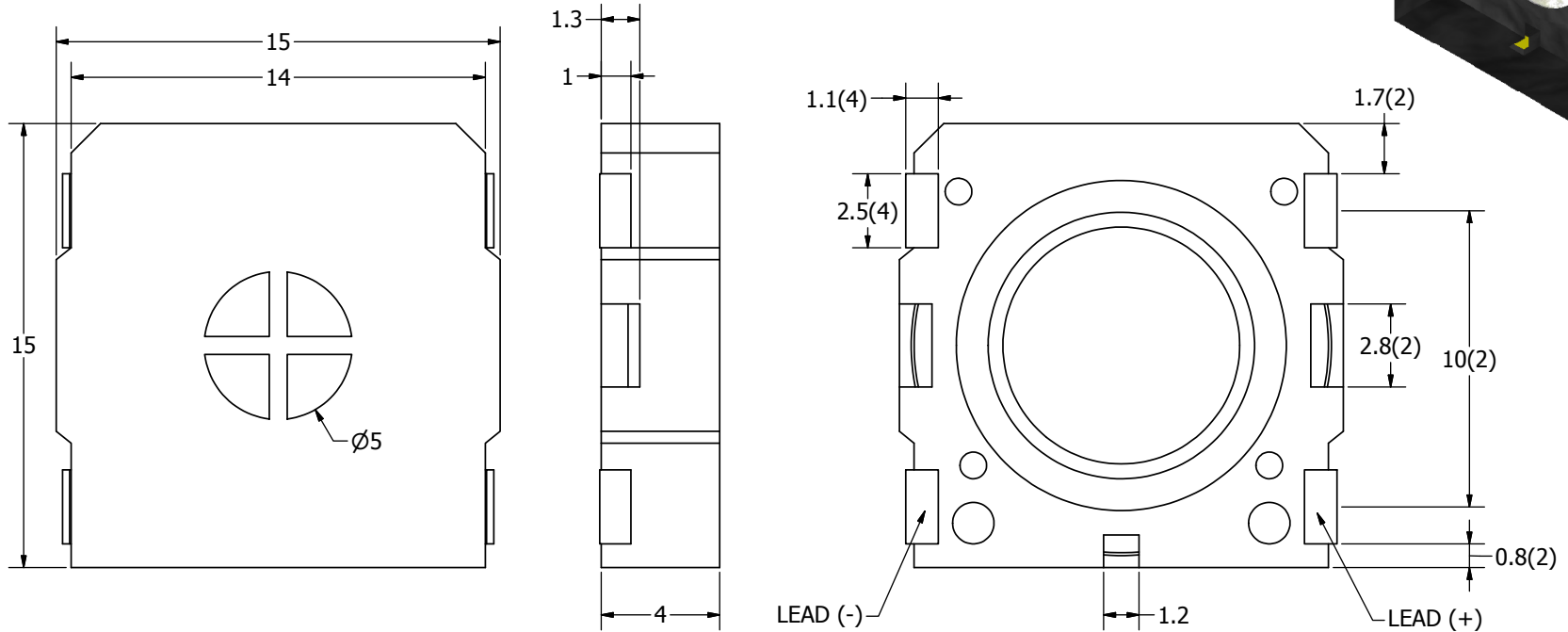

NOTES:

1. ALL DIMENSIONS ARE IN MILLIMETERS.
2. SPECIFICATIONS SUBJECT TO CHANGE OR WITHDRAWAL WITHOUT NOTICE.
3. THIS PART IS RoHS 2002/95/EC COMPLIANT.

UNLESS OTHERWISE SPECIFIED: DIMENSIONS ARE IN MILLIMETERS, TOLERANCES ARE ±0.5 AND ANGLES ARE ±3°.	SIZE A3	Designed by	Date	Checked by	Date	Approved by	Date	Drawn Date
		J.D.	8/9/2011	M.L.	8/10/2011	B.R.	8/10/2011	8/9/2011
SMS-1508MS-2-R.idw		 SMS-1508MS-2-R Speaker				Edition	Sheet	
						-	1 / 1	