

## Description

The MSL-154DR, a RED source Chip LED device, is designed in an industry standard package suitable for SMT assembly method. It utilizes AlGaAs on GaAs LED chip technology and water clear epoxy package.

## Applications

- Small Size
- Industry Standard Footprint(1206)
- Compatible with IR Solder process
- Available in 8 mm Tape on 7"(178mm)

Diameter Reels

## Features

- Push-Button Backlighting
- LCD Backlighting
- Symbol Backlighting
- Front Panel Indicator

## Absolute Maximum Ratings

@  $T_A=25^{\circ}\text{C}$

Parameter	Symbol	Maximum Rating	Unit
Peak Forward Current(1/10 Duty Cycle@1KHz )	$I_{FP}$	200	mA
DC Forward Current	$I_F$	25	mA
Power Dissipation	$P_D$	55	mW
Reverse Voltage	$V_R$	5	V
Operating Temperature Range	$T_{OPR}$	-25°C to +80°C	
Storage Temperature Range	$T_{STG}$	-30°C to +85°C	

## Package Dimensions

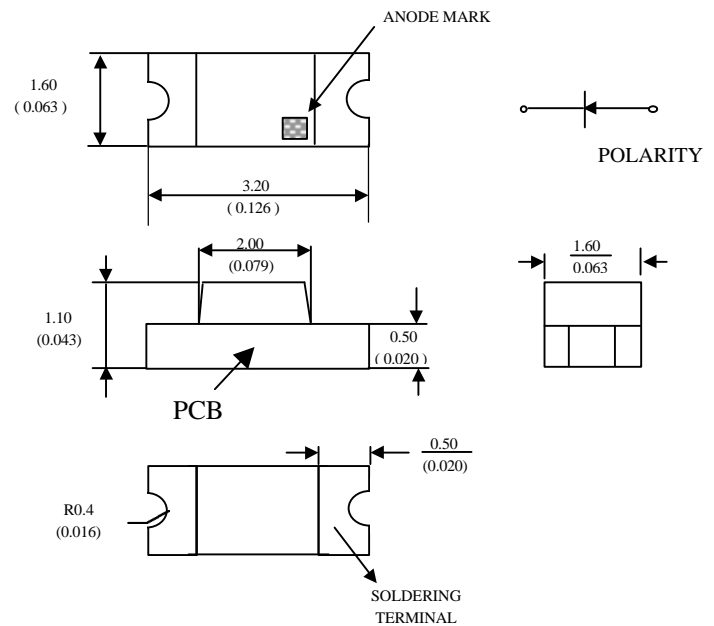

## Recommended Solder Patterns

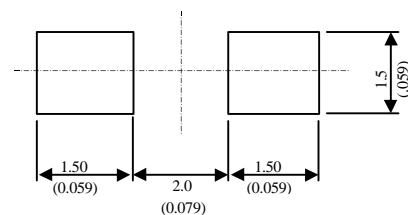

### NOTE:

1. All dimensions are in millimeter (inches)
2. Tolerance is  $\pm 0.1\text{mm}$  (.004") unless otherwise specified.

## Optical-Electrical Characteristics

@ T<sub>A</sub>=25°C

Parameter	Test Conditions	Symbol	Min .	Typ .	Max .	Unit .
Luminous Intensity	I <sub>F</sub> =20mA	I <sub>V</sub>	10	21.5	-	mcd
Forward Voltage	I <sub>F</sub> =20mA	V <sub>F</sub>	-	1.9	2.0	V
Reverse Current	V <sub>R</sub> =5V	I <sub>R</sub>	-	-	10	μA
Peak/Dominant Wavelength	I <sub>F</sub> =20mA	λ <sub>p</sub> /λ <sub>d</sub>	-	660/640	-	nm
Spectral Linewidth	I <sub>F</sub> =20mA	Δλ	-	20	-	nm
Viewing Angle	I <sub>F</sub> =20mA	2θ <sub>1/2</sub>	-	130	-	deg.

## Typical Optical-Electrical Characteristic Curves

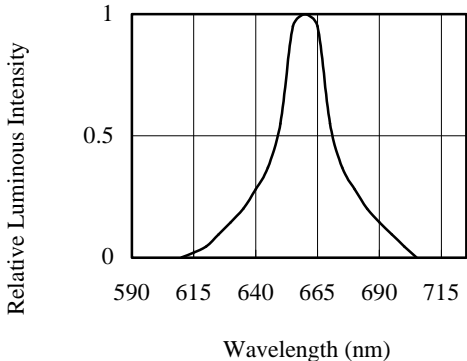

FIG. 1 RELATIVE INTENSITY LUMINOUS VS. WAVELENGTH

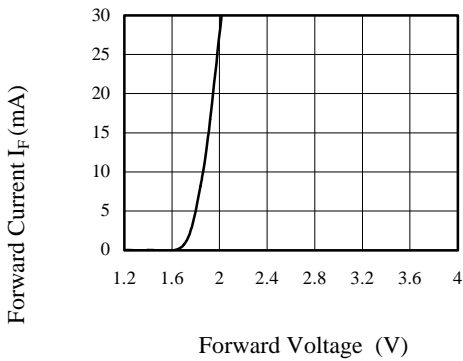

FIG. 2 FORWARD CURRENT VS. FORWARD VOLTAGE.

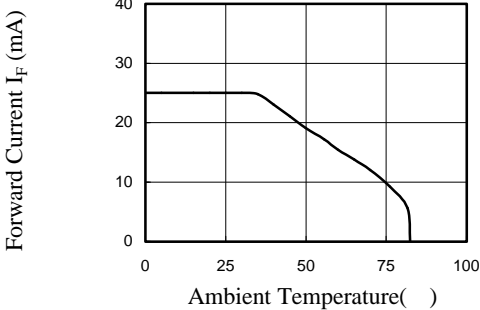

FIG. 3 FORWARD CURRENT VS. AMBIENT TEMPERATURE.

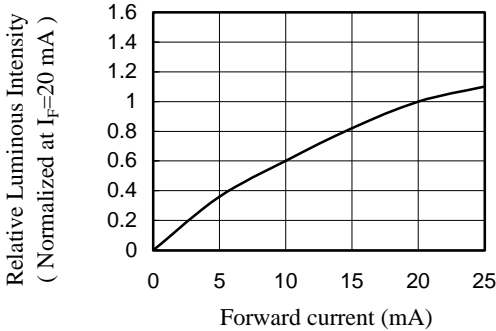

FIG. 4 RELATIVE LUMINOUS INTENSITY VS. FORWARD CURRENT.

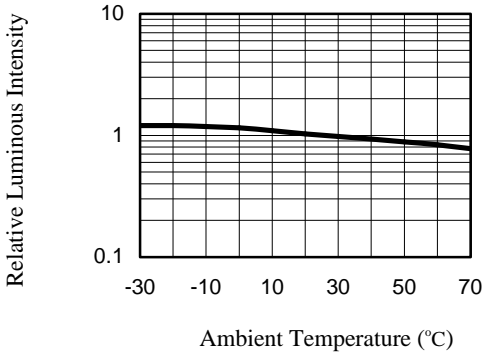

FIG. 5 LUMINOUS INTENSITY VS. AMBIENT TEMPERATURE

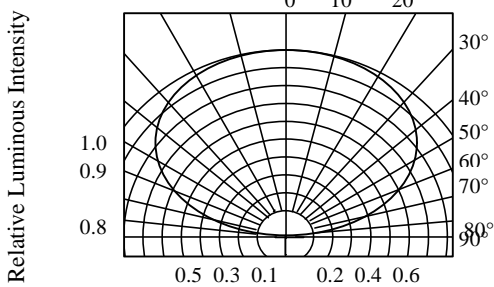

FIG. 6 RADIATION DIAGRAM