

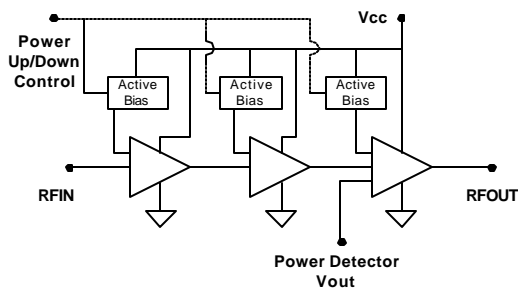

Product Description

Sirenza Microdevices' SZA-5044 is a high efficiency class AB Heterojunction Bipolar Transistor (HBT) amplifier housed in a low-cost surface-mountable plastic package. This HBT amplifier is made with InGaP on GaAs device technology and fabricated with MOCVD for an ideal combination of low cost and high reliability. This product is specifically designed as a final or driver stage for 802.11a equipment in the 4.9 - 5.9 GHz band for a 5V supply. Optimized on-chip impedance matching circuitry provides a 50Ω nominal RF input impedance. A single external output matching circuit covers the entire 4.9-5.9GHz band simultaneously. The external output match allows for load line optimization for other applications or optimized performance over narrower bands. This product is available in a RoHS Compliant and Green package with matte tin finish, designated by the "Z" package suffix.

Functional Block Diagram



Key Specifications

Symbol	Parameters: Test Conditions, App circuit page 4 $Z_0 = 50\Omega$, $V_{CC} = 5.0V$, $I_{CQ} = 270mA$, $T_{BP} = 25^\circ C$	Unit	Min.	Typ.	Max.
f_O	Frequency of Operation	MHz	4900		5900
P_{1dB}	Output Power at 1dB Compression – 5.15 GHz	dBm		30.2	
	Output Power at 1dB Compression – 5.875 GHz		27.5	29	
S_{21}	Gain at 4.9 GHz	dB	30.7	32.7	34.7
	Gain at 5.15 GHz	dB		33.0	
	Gain at 5.875 GHz	dB	25.7	27.7	29.7
P_{out}	Output power at 3% EVM 802.11a 54Mb/s - 5.15GHz	dBm		21	
	Output Power at 3% EVM 802.11a 54Mb/s - 5.875GHz			22	
NF	Noise Figure at 5.875 GHz	dB		6.3	
IM3	Third Order Intermod at 18dBm per tone - 5.875GHz	dBc		-39	-35
IRL	Worst Case Input Return Loss 4.9-5.875GHz	dB	8.6	11.6	
ORL	Worst Case Output Return Loss 4.9-5.875GHz		9.3	12.3	
Vdet Range	Output Voltage Range for $P_{out}=10dBm$ to $26dBm$	V		0.8 to 1.9	
I_{CQ}	V_{CC} Quiescent Current	mA	230	270	310
I_{VPC}	Power Up Control Current, $V_{pc}=5V$ ($I_{VPC1} + I_{VPC2} + I_{VPC3}$)	mA		1.7	
I_{LEAK}	Off V_{CC} Leakage Current $V_{pc}=0V$	uA		8	100
$R_{th, j-l}$	Thermal Resistance (junction - lead)	$^\circ C/W$		24	

The information provided herein is believed to be reliable at press time. Sirenza Microdevices assumes no responsibility for inaccuracies or omissions. Sirenza Microdevices assumes no responsibility for the use of this information, and all such information shall be entirely at the user's own risk. Prices and specifications are subject to change without notice. No patent rights or licenses to any of the circuits described herein are implied or granted to any third party. Sirenza Microdevices does not authorize or warrant any Sirenza Microdevices product for use in life-support devices and/or systems.

Copyright 2002 Sirenza Microdevices, Inc. All worldwide rights reserved.
303 South Technology Court Broomfield, CO 80021

Phone: (800) SMI-MMIC

<http://www.sirenza.com>
EDS-103585 Rev H

SZA-5044

SZA-5044Z RoHS Compliant & GreenPackage

4.9 – 5.9 GHz 5V Power Amplifier



4mm x 4mm QFN Package

Product Features

- 802.11a 54Mb/s Class AB Performance
Pout = 22dBm @ 3% EVM, 5V, 343mA
- High Gain = 33dB
- Output Return Loss < -11dB for Linear Tune
- On-chip Output Power Detector
- P1dB = 30dBm @ 5V
- Simultaneous 4.9- 5.9GHz Performance
- Robust - Survives RF Input Power = +15dBm
- Power up/down control < 1μs, Vpc 2.9V to 5V

Applications

- 802.11a WLAN, OFDM
- 5.8GHz ISM Band, 802.16 WiMAX

Pin Out Description

Pin #	Function	Description
1,3,5,9,11,15,17	N/C	Pins are not used. May be grounded, left open, or connected to adjacent pin.
6	VPC1	VPC1 is the bias control pin for the stage 1 active bias circuit and can be run from 2.9V to 5V control. An external series resistor is required for proper setting of bias levels depending on control voltage. Refer to the evaluation board schematic for resistor value. To prevent potential damage, do not apply voltage to this pin that is +1V greater than voltage applied to pin 20 (Vbias) unless Vpc supply current capability is less than 10 mA.
7	VPC2	VPC2 is the bias control pin for the stage 2 active bias circuit and can be run from 2.9V to 5V control. An external series resistor is required for proper setting of bias levels depending on control voltage. Refer to the evaluation board schematic for resistor value. To prevent potential damage, do not apply voltage to this pin that is +1V greater than voltage applied to pin 20 (Vbias) unless Vpc supply current capability is less than 10 mA.
8	VPC3	VPC3 is the bias control pin for the stage 3 active bias circuit and can be run from 2.9V to 5V control. An external series resistor is required for proper setting of bias levels depending on control voltage. Refer to the evaluation board schematic for resistor value. To prevent potential damage, do not apply voltage to this pin that is +1V greater than voltage applied to pin 20 (Vbias) unless Vpc supply current capability is less than 10 mA.
10	Vdet	Ouput power detector voltage. Load with 10K-100K ohms to ground for best performance.
2,4	RFIN	RF input pins. This is DC grounded internal to the IC. Do not apply voltage to this pin. All three pins must be used for proper operation.
12,13,14	RFOUT	RF output pin. This is also another connection to the 3rd stage collector
16	VC3	3rd stage collector bias pin. Apply 5V to this pin.
18	VC2	2nd stage collector bias pin. Apply 5V to this pin.
19	VC1	1st stage collector bias pin. Apply 5V to this pin.
20	Vbias	Active bias network VCC. Apply 5V to this pin.
EPAD	Gnd	Exposed area on the bottom side of the package needs to be soldered to the ground plane of the board for optimum thermal and RF performance. Several vias should be located under the EPAD as shown in the recommended land pattern (page 5).

Simplified Device Schematic

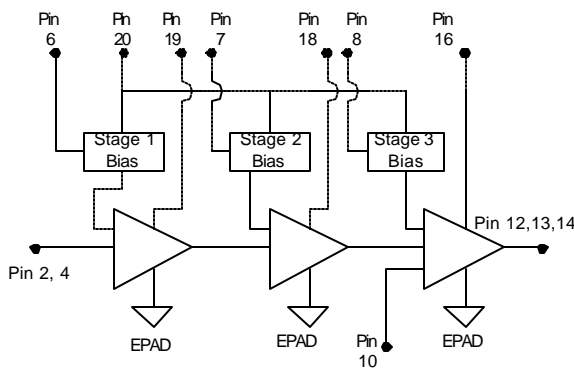

Absolute Maximum Ratings

Parameters	Value	Unit
VC3 Collector Bias Current (pin16)	500	mA
VC2 Collector Bias Current (pin18)	225	mA
VC1 Collector Bias Current (pin19)	75	mA
Device Voltage (V _D)	7.0	V
Power Dissipation	3.4	W
Operating Lead Temperature (T _L)	-40 to +85	°C
RF Input Power for 50 ohm RF out load	15	dBm
RF Input Power for 10:1 VSWR RF out load	2	dBm
Storage Temperature Range	-40 to +150	°C
Operating Junction Temperature (T _J)	+150	°C
ESD Human Body Model	>1000	V

Operation of this device beyond any one of these limits may cause permanent damage. For reliable continuous operation the device voltage and current must not exceed the maximum operating values specified in the table on page one.

Bias conditions should also satisfy the following expression:

$$I_D V_D < (T_J - T_{L}) / R_{TH} j-1$$



Caution: ESD Sensitive

Appropriate precaution in handling, packaging and testing devices must be observed.

4.9 - 5.9 GHz Evaluation Board Data ($V_{BIAS} = 5.0V$, $I_q = 270mA$)

Broadband S11 - Input Return Loss

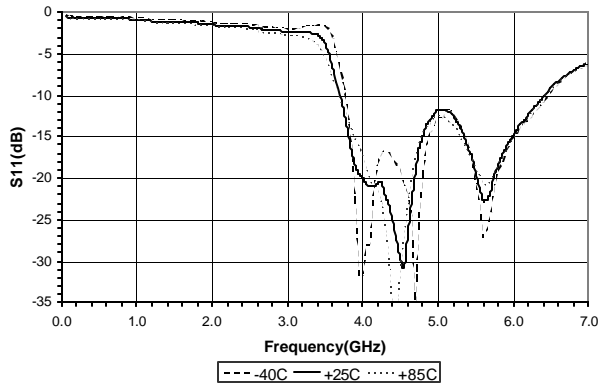

Broadband S21 - Forward Gain

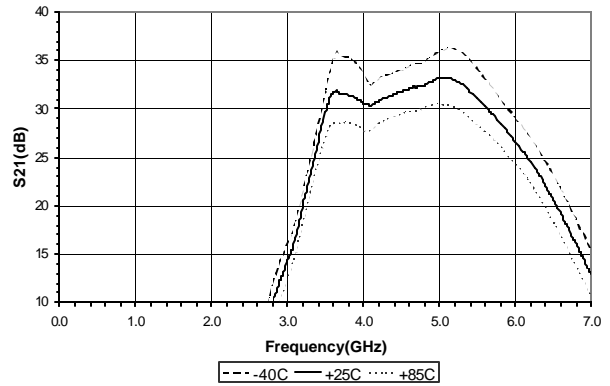

Broadband S22 - Output Return Loss

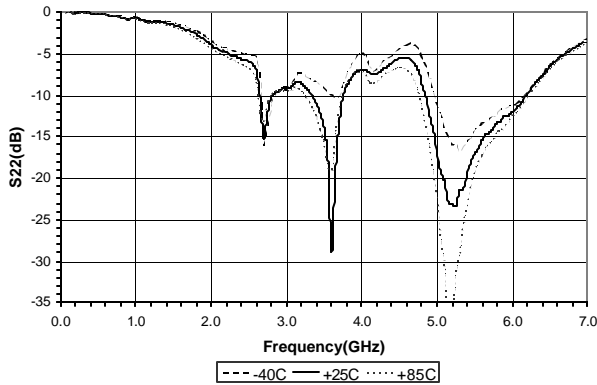

Typical Gain vs Pout, T=+25C

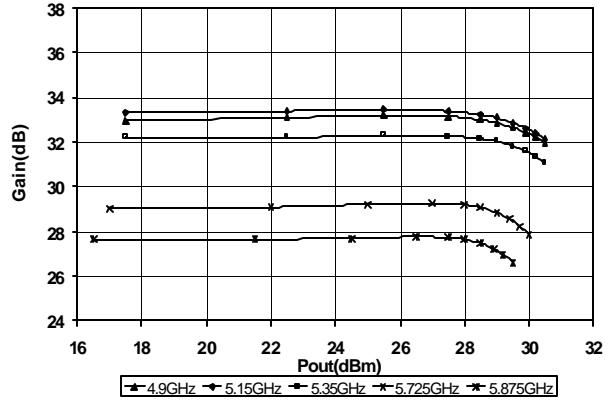

DC Supply Current vs Pout, T=+25c

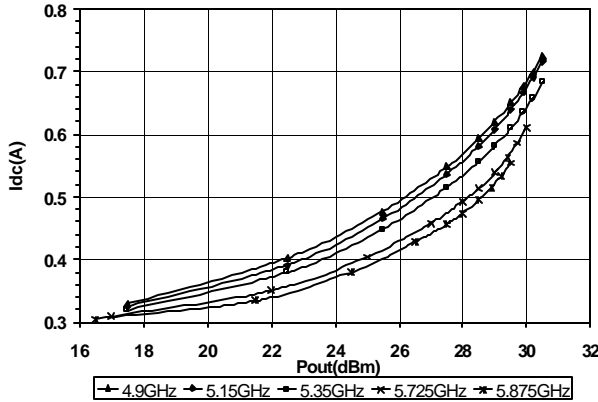

Icq (DC bias point) vs Vsupply (V+ and Vpc)

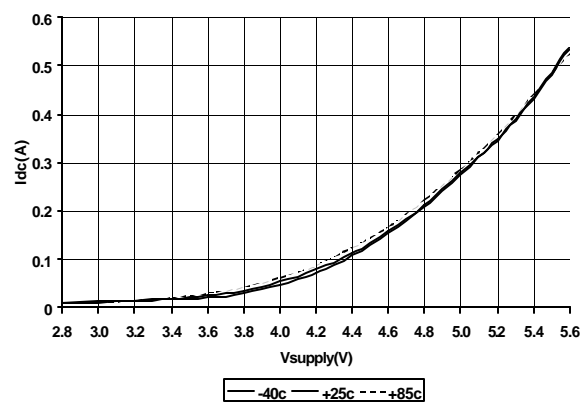

4.9 - 5.9 GHz Evaluation Board Data ($V_{BIAS} = 5.0V$, $I_q = 270mA$)
 802.11a EVM, OFDM, 54Mb/s, 64QAM

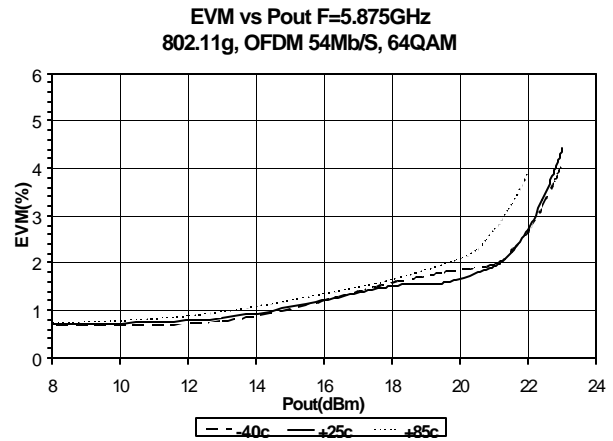
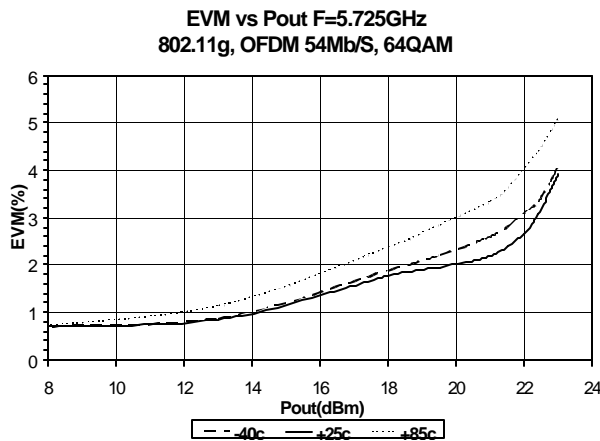
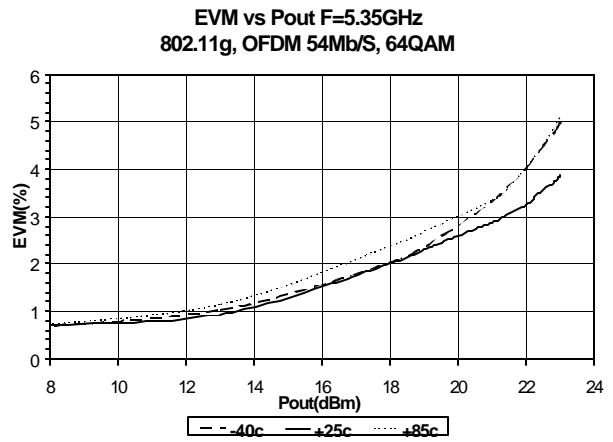
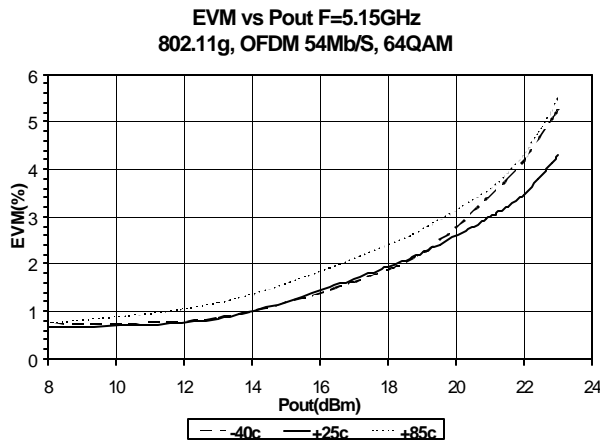
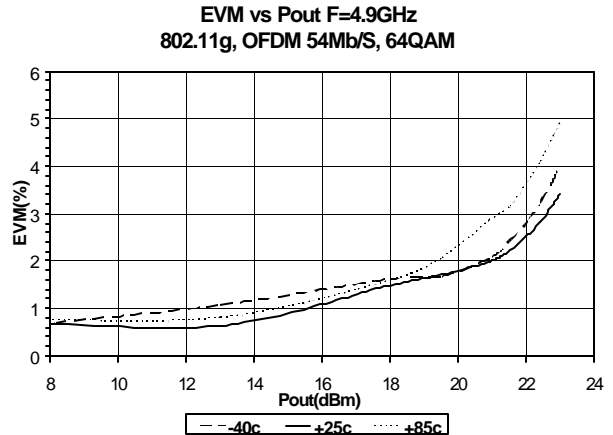
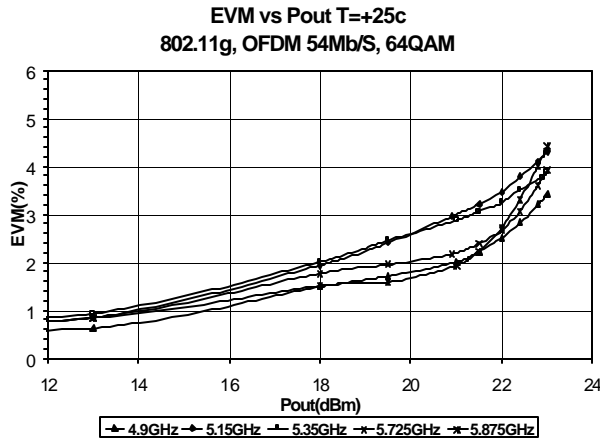

4.9 - 5.9 GHz Evaluation Board Data ($V_{BIAS} = 5.0V$, $I_q = 270mA$)

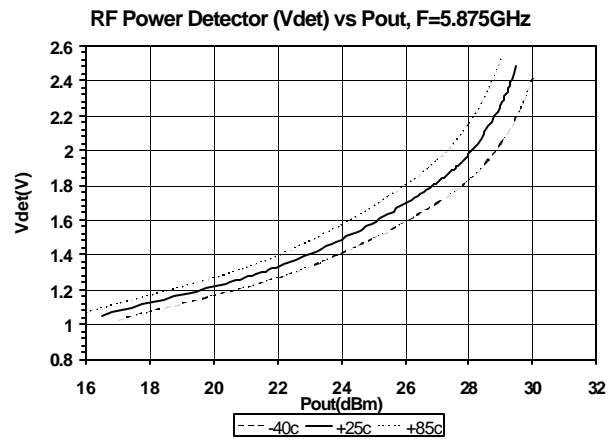
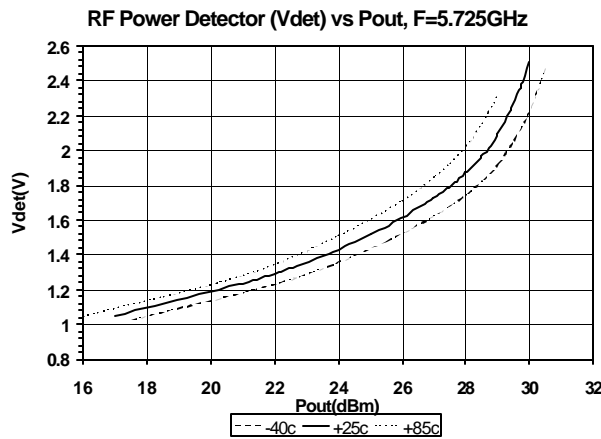
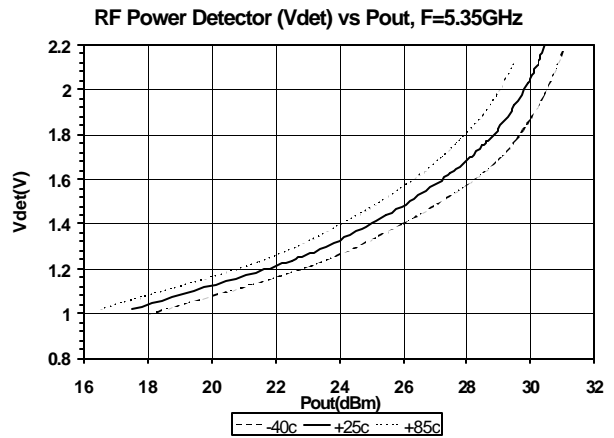
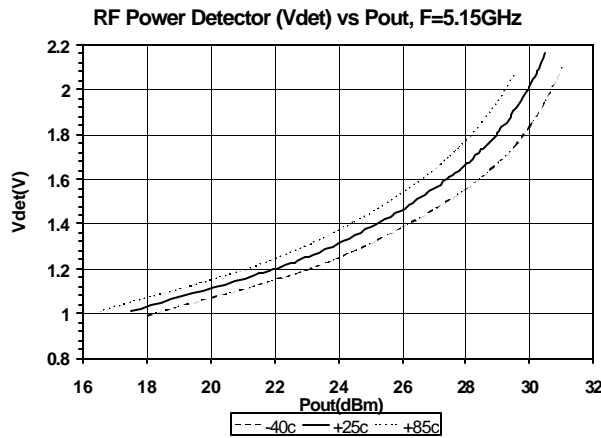
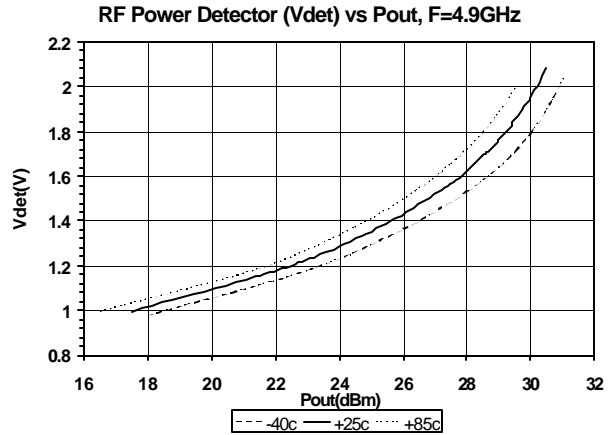
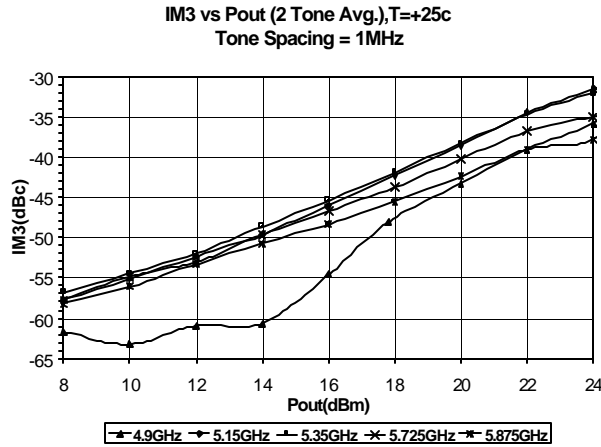

4.9 - 5.9 GHz Evaluation Board Schematic For V+ = Vcc = 5.0V

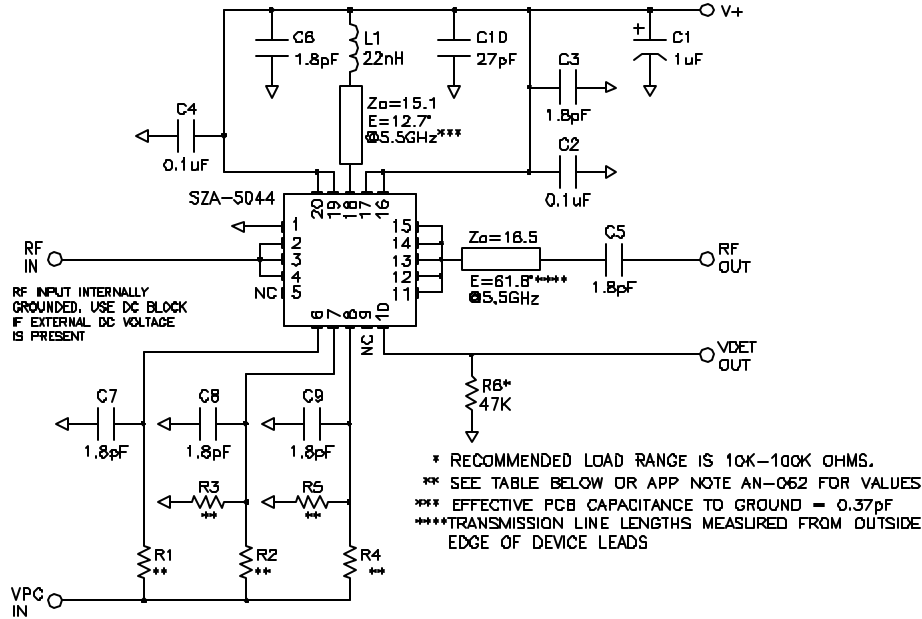

Notes:

Pins 1,3,5,9,11,15 and 17 are unwired (N/C) inside the package. Refer to page 2 for detailed pin descriptions. Some of these pins are wired to adjacent pins or grounded as shown in the application circuit. This is to maintain consistency with the evaluation board layout shown below. It is recommended to use this layout and wiring to achieve the specified performance.

To prevent potential damage, do not apply voltage to the Vpc pin that is +1V greater than voltage applied to pin 20 (Vbias/Vcc) unless Vpc supply current capability is less than 10 mA.

4.9 - 5.9 GHz Evaluation Board Layout For V+ = Vcc = 5.0V

- Board material GETEK, 10mil thick, Dk=3.9, 2 oz. copper finish

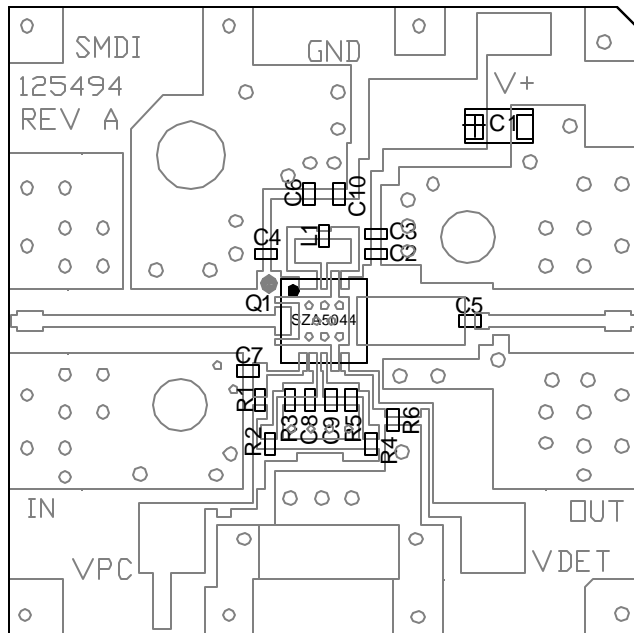

DESC	DESCRIPTION
Q1	SZA-5044
R1,2,3,4,5,6	1%, 0402
C1	1uF 16V TANTALUM CAP
C2,4	0.1uF CAP, 0402
C3,5,6,7,8,9	1.8pF CAP, 0402
C10	27pF CAP, 0402
L1	22nH IND, 0402

Resistor values for Vpc=2.9V to 5V (Vcc=5V, Iq=270mA)

VPC(V)	R1	R2	R4	R3	R5
2.9	0	698	10	OUT	OUT
3.0	174	1.1K	261	OUT	OUT
3.1	348	1.37K	499	OUT	OUT
3.2	511	1.78K	750	OUT	OUT
3.3	698	2.15K	1.0DK	OUT	OUT
5.0	3.74K	2.49K	2.61K	7.5K	7.5K

Note: See app note AN-062 for other Vcc and Vpc combinations

PCB Notes:

Do not use less than recommended ground via holes
 RF Layers thicker than .020 inches (0.5mm) not recommended.

Part Symbolization

The part will be symbolized with an "SZA-5044" for Sn/Pb plating or "SZA-5044Z" for RoHS green compliant product. Marking designator will be on the top surface of the package.

Part Number Ordering Information

Part Number	Reel Size	Devices/Reel
SZA-5044	13"	3000
SZA-5044Z	13"	3000

Package Outline Drawing (dimensions in mm): Refer to package outline drawing for more detail.

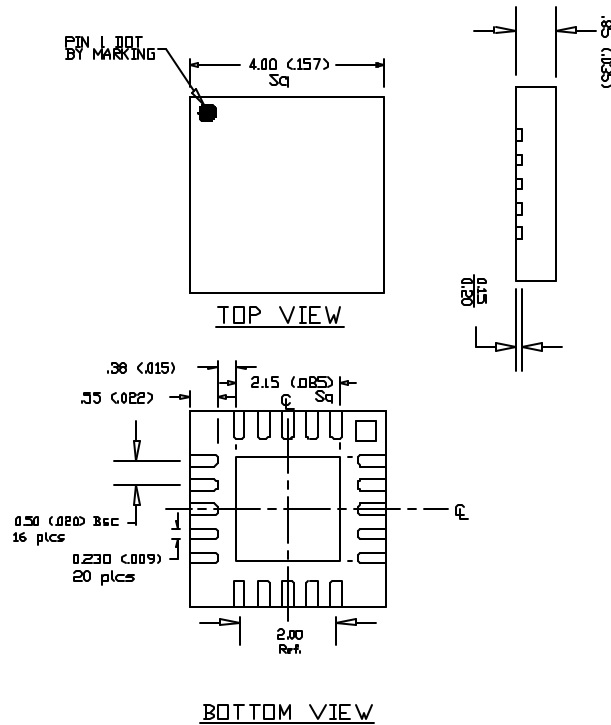

Recommended Land Pattern (dimensions in mm[in])

Recommended PCB Soldermask (SBOC) for Land Pattern (dimensions in mm[in]):

