



PICO® 305 Series - 277V Intrinsically Safe Fuse



Agency Approvals

Agency	Agency File Number
	DEMKO 13 ATEX 1200U
	E358130
	IECEX UL 13.0077U

Reference Standards

Agency	Standards
ATEX	EN 60079-0, EN 60079-11, EN 60079-26
IECEX	IEC 60079-0, IEC 60079-11, IEC 60079-26
UL	UL 913, UL 60079-0, UL 60079-11
cUL	CAN/CSA C22.2 No. 157, CAN/CSA C22.2 No. 60079-0, CAN/CSA C22.2 No. 60079-11

Description

The PICO® 305 Series Fuse offers a range of encapsulated fuses certified under UL 913, the standard for intrinsically safe electrical equipment, to operate in hazardous locations. Ideal for use in oil, gas, mine, chemical, and pharmaceutical process industries, the PICO 305 Series fuse was designed to limit the energy and temperature generated during its operation. The fuse design and its encapsulant are suitable for use in an intrinsically safe apparatus and associated apparatus for peak voltage not exceeding 375V.

Features

- High Interrupting Rating of 1500A
- Well suited for 277V applications
- RoHS Compliant
- Designed for operation in a range of hazardous environments
- Encapsulated and sealed (1mm minimum)
- Global hazardous location certifications



Applications

- Testing, measuring or processing electronic and electrical equipment
- Motor controllers
- Communication handsets
- Process control and automation
- Sensors
- Lighting
- Flow/gas meters

Electrical Characteristics for Series

% of Ampere Rating	Opening Time
110%	4 Hours, Minimum
300%	10 Seconds, Maximum
1000%	0.002 Seconds, Maximum

Electrical Specifications by Items

Ampere Rating (A)	Amp Code	Interrupting Rating	Nominal Melting I ² t (A ² Sec.)	Minimum Cold Resistance at -20°C (Ohms)	Minimum Cold Resistance at -40°C (Ohms)	Nominal Cold Resistance at 25°C (Ohms)	Agency Approvals		
									
0.050	.050	1500A @ 277VAC/DC	0.00019	9.202	9.010	12.00	x	x	x
0.080	.080		0.00035	6.031	5.963	8.19	x	x	x
0.100	.100		0.00070	2.709	2.668	5.00	x	x	x
0.160	.160		0.00202	2.297	2.292	3.00	x	x	x
0.200	.200		0.00288	1.935	1.839	2.68	x	x	x
0.250	.250		0.060050	1.268	1.105	1.60	x	x	x
0.500	.500		0.127400	0.392	0.368	0.46	x	x	x
0.750	.750		0.13448	0.219	0.196	0.27	x	x	x

Notes:

- 1) The fuse must be mounted so that creepage and clearance distances aren't impaired in any way.
- 2) The fuse is suitable for use in intrinsically safe equipment and associated apparatus for voltage not exceeding 375V peak.
- 3) Maximum surface temperature rise at 170% rated current: ≤200mA=80°C, 250mA = 84°C, 500mA = 56°C, and 750mA = 84°C.

Product Characteristics

Operating Temperature

Current Rating	Ambient Temperature
≤ 0.200 A	- 40°C to +50°C
0.250 A	- 40°C to +46°C
0.500 A	- 40°C to +74°C
0.750 A	- 40°C to +46°C

Notes:

- 1) Any use of the 305 Series fuse outside of the ambient temperature ranges specified in the table is subject to additional investigation.
- 2) Specified ambient temperature range is for intrinsic safety certification.

Molding Material	Polyamide 6 CTI 175 volts minimum Continuous Operating Temperature: 130°C
Thermal Shock	Withstands 5 cycles of -55°C to 125°C
Vibration	Per MIL-STD-202
Insulation Resistance (After Opening)	Greater than 10,000 ohms (at twice rated DC voltage)

Soldering Parameters

Wave Soldering	260°C, 10 seconds max.
-----------------------	------------------------

Dimensions

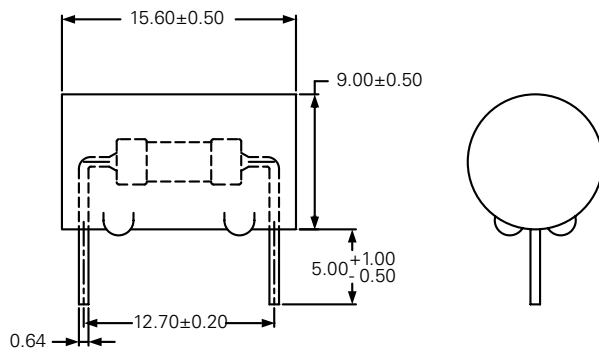

Part Numbering System

0305 .050 M

SERIES

AMP CODE

Refer to Amp Code column in the Electrical Specifications table.

QUANTITY & PACKAGING CODE

- M = Bulk pack, 1000 pcs
- H = Bulk pack, 100 pcs
- V = Bulk pack, 5 pcs

Average Time Current Curves

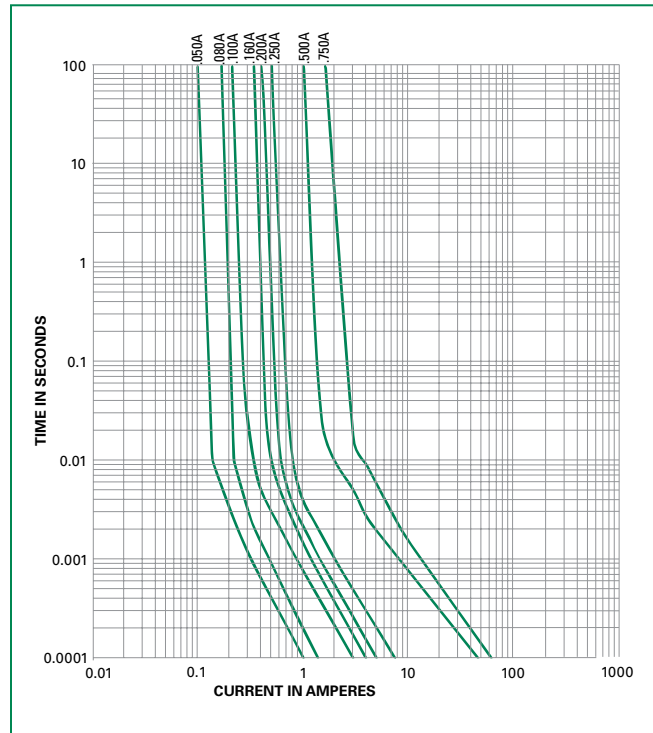

Temperature Rerating Curve

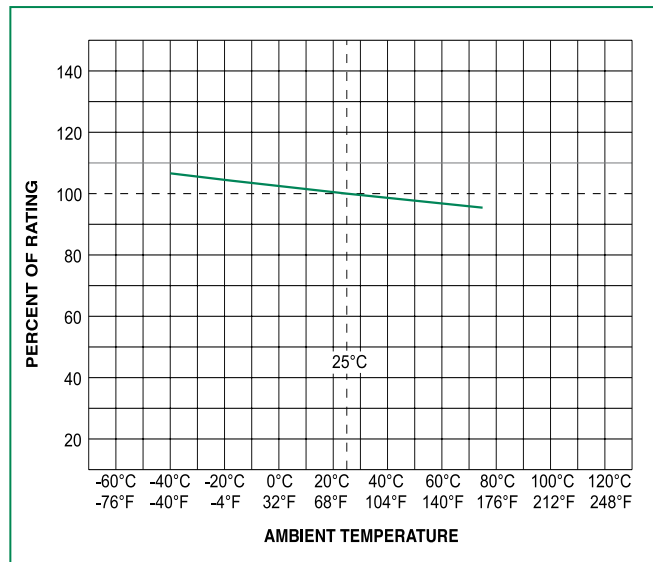

Notes:

- 1) Rerating depicted in this curve is in addition to the standard rerating of 25% for continuous operation.
- 2) The temperature rerating curve represents the nominal conditions. For questions about temperature rerating curve, please consult Littelfuse technical support for assistance.