

Series 801 Right Angle PCB Headers



**Series 801 Right Angle PCB
Receptacle**

It's not easy to find the right waterproof, rugged, fully shielded connector for military-grade Ethernet switches and other high speed differential impedance applications. Glenair's new right angle 801-023 connectors offer military grade performance in a small, lightweight package. Ideal for 100/1000BASE-T or IEEE 1394, these connectors are rated for MIL-STD-810 Method 512 immersion. Eliminate the extra labor to install jumpers from your board to conventional mil-spec circular connectors.

Series 801 Right Angle PCB Receptacles for attachment to motherboards.

Jam Nut Rear Panel Mounting

Environmentally Sealed – A fluorosilicone o-ring provides sealing to the panel. The PCB housing is filled with epoxy to prevent water ingress through the connector.

HOW TO ORDER

Sample Part Number

801-023	-07	M	7-10	P	A
Series	Shell Style	Shell Material / Finish	Shell Size- Insert Arrangement	Contact Type	Shell Key Position
801-023 PCB Receptacle	 -07 – Jam Nut	C Aluminum / Black Anodize	5-3 3 #23 6-4 4 #23 6-7 7 #23 7-10 10 #23 8-13 13 #23	P Pin	A Normal
		M Aluminum / Electroless Nickel		S Socket	B Pos. B
		NF Aluminum / Cadmium with Olive Drab Chromate		C Pos. C	
		ZN Aluminum / Zinc-Nickel with Olive Drab Chromate		D Pos. D	
		ZNU Aluminum / Zinc-Nickel with Black Chromate			
		Z1 Stainless Steel / Passivated			

Series 801 Right Angle PCB Headers

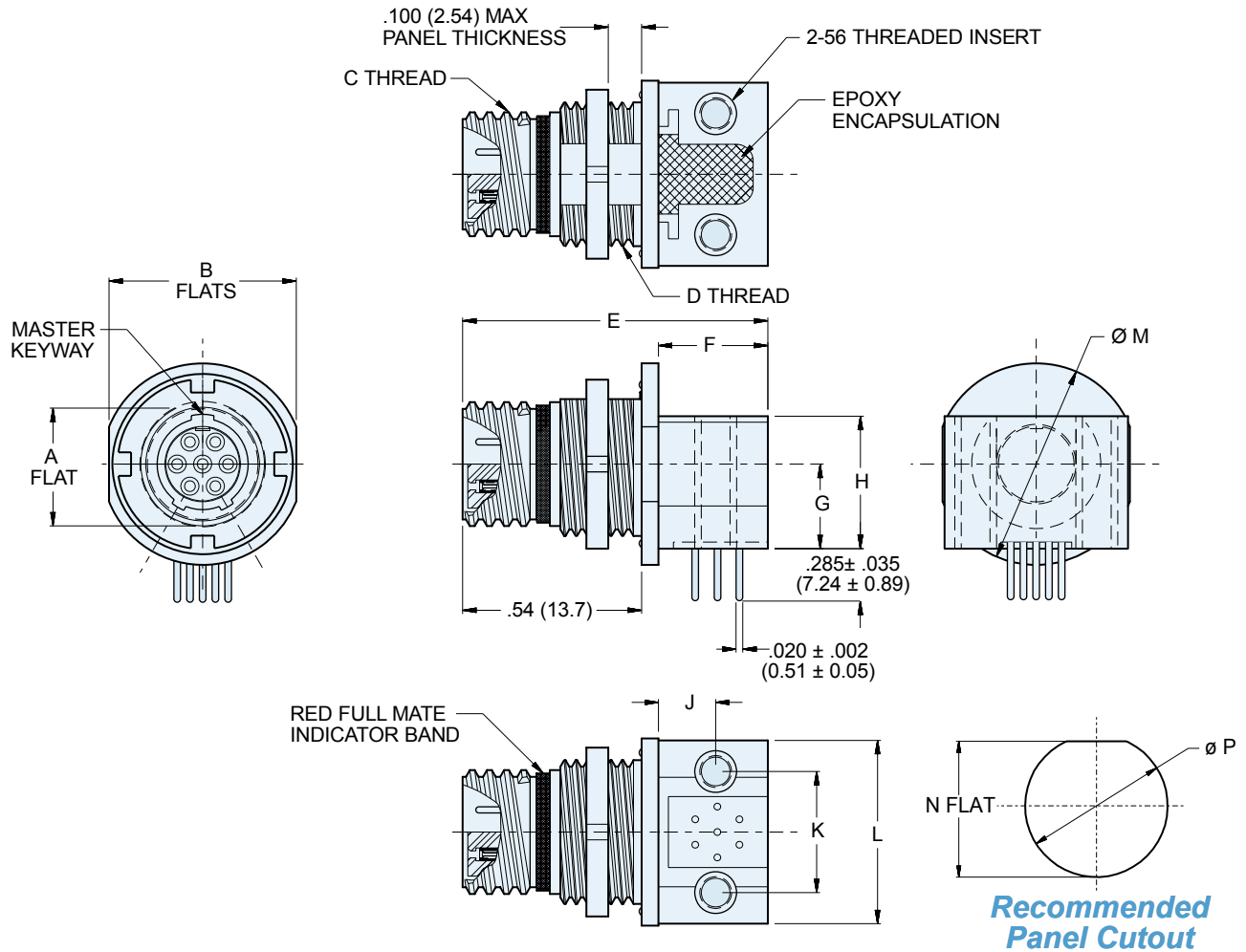

DIMENSIONS

Shell Size	A		B		C Threads	D Threads	E Max.		F Max.		G		H Max.	
	In.	mm.	In.	mm.			In.	mm.	In.	mm.	In.	mm.	In.	mm.
5-3	.350	8.89	.545	13.84	.3125-.05P-.1L-2A	.375-28 UN-2A	.890	22.61	.290	7.37	.207	5.26	.430	10.92
6-4	.410	10.41	.602	15.29	.3750-.05P-.1L-2A	.4375-28 UNEF-2A	.950	24.13	.360	9.14	.232	5.89	.470	11.94
6-7	.410	10.41	.602	15.29	.3750-.05P-.1L-2A	.4375-28 UNEF-2A	.980	24.89	.380	9.65	.232	5.89	.470	11.94
7-10	.536	13.61	.723	18.36	.4375-.05P-.1L-2A	.5625-32 UN-2A	.980	24.89	.380	9.65	.296	7.52	.590	14.99
8-13	.536	13.61	.723	18.36	.5000-.05P-.1L-2A	.5625-32 UN-2A	1.120	28.45	.520	13.21	.330	8.38	.640	16.26

Shell Size	J		K		L Max.		Ø M Max.		N		Ø P	
	In.	mm.	In.	mm.	In.	mm.	In.	mm.	In.	mm.	In.	mm.
5-3	.165	4.19	.310	7.87	.520	13.21	.610	15.49	.360	9.14	.385	9.78
6-4	.224	5.69	.385	9.78	.610	15.49	.670	17.02	.420	10.67	.448	11.37
6-7	.187	4.75	.408	10.36	.610	15.49	.670	17.02	.420	10.67	.448	11.37
7-10	.170	4.32	.452	11.48	.670	17.02	.790	20.07	.551	14.00	.573	14.55
8-13	.230	5.84	.490	12.45	.710	18.03	.790	20.07	.551	14.00	.573	14.55

Patterns shown are for component mounting side of PCB.

RIGHT ANGLE PCB FOOTPRINTS: PIN CONNECTORS

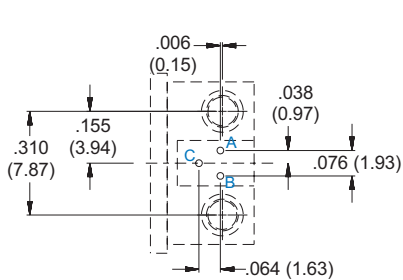

5-3P

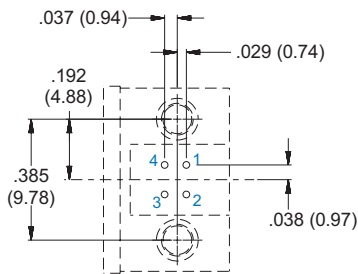

6-4P

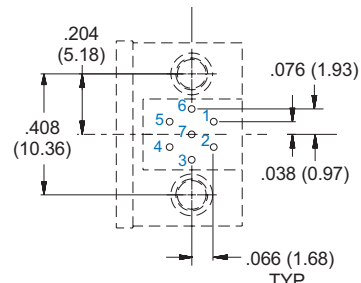

6-7P

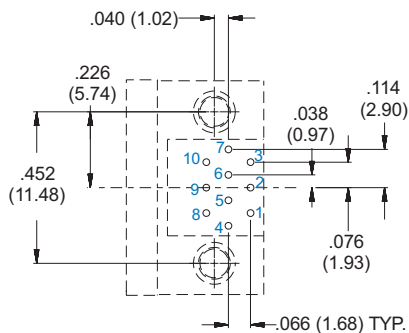

7-10P

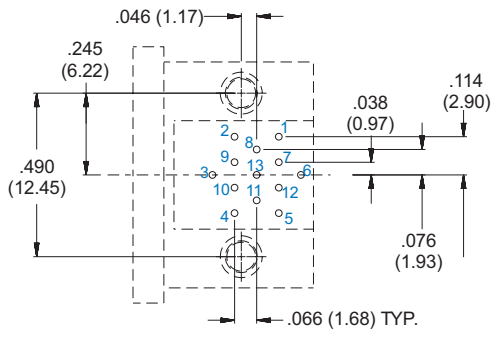

8-13P

RIGHT ANGLE PCB FOOTPRINTS: SOCKET CONNECTORS

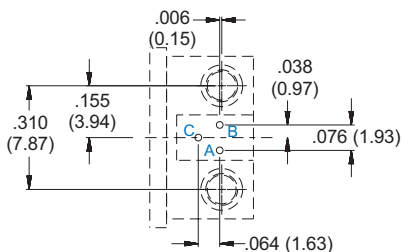

5-3S

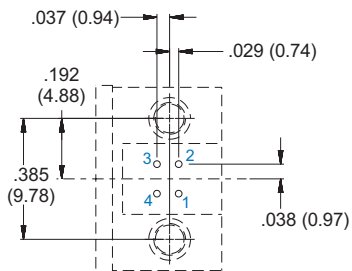

6-4S

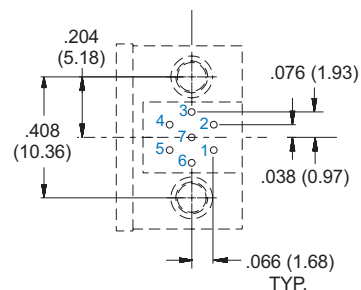

6-7S

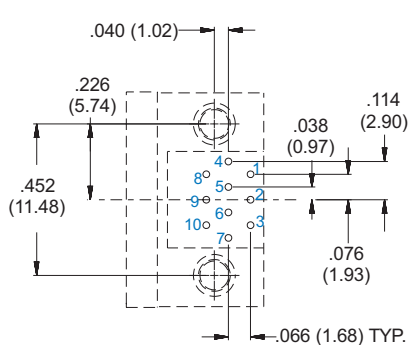

7-10S

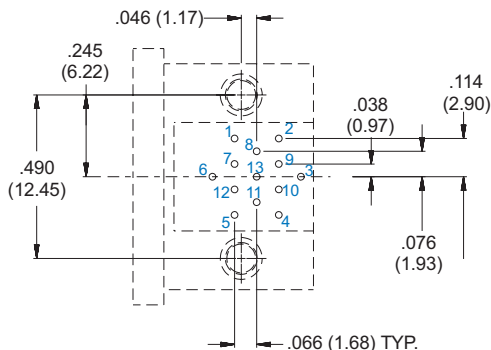

8-13S