

Standard Recovery Diodes (Hockey PUK Version), 2140A

FEATURES

- Wide current range
- High voltage ratings up to 3600V
- High surge current capabilities
- Diffused junction
- Hockey PUK version
- Case style DO-220AC(K-PUK), Nell's D-type Cap
- Lead (Pb)-free

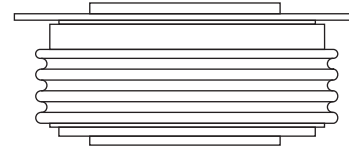

DO-220AC(K-PUK)
(Nell's D-type)

TYPICAL APPLICATIONS

- Converters
- Power supplies
- Machine tool controls
- High power drives
- Medium traction applications

PRODUCT SUMMARY	
$I_{F(AV)}$	2140A

MAJOR RATINGS AND CHARACTERISTICS			
PARAMETER	TEST CONDITIONS	VALUES	UNIT
$I_{F(AV)}$		2140	A
	T_{hs}	55	°C
$I_{F(RMS)}$		3700	A
	T_{hs}	25	°C
I_{FSM}	50 HZ	24000	A
	60 HZ	25100	
I^2t	50 HZ	2880	kA ² s
	60 HZ	2615	
V_{RRM}		2600 to 3600	V
T_J	Typical	-40 to 150	°C

ELECTRICAL SPECIFICATIONS

VOLTAGE RATINGS				
TYPE NUMBER	VOLTAGE CODE	V_{RRM} , MAXIMUM REPETITIVE PEAK REVERSE VOLTAGE V	V_{RSM} , MAXIMUM NON-REPETITIVE PEAK REVERSE VOLTAGE V	I_{RRM} , MAXIMUM AT $T_J = T_J$ MAXIMUM mA
D2140D	26	2600	2700	50
	30	3000	3100	
	36	3600	3700	

FORWARD CONDUCTION					
PARAMETER	SYMBOL	TEST CONDITIONS		VALUES	UNIT
Maximum average forward current at heatsink temperature	$I_{F(AV)}$	180° conduction, half sine wave Double side (single side) cooled		2140(1000)	A
				55(85)	°C
Maximum RMS forward current	$I_{F(RMS)}$	25°C heatsink temperature double side cooled		3700	A
Maximum peak, one cycle non-repetitive surge current	I_{FSM}	t = 10ms	No voltage reapplied	Sinusoidal half wave, initial $T_J = T_J$ maximum	A
		t = 8.3ms			
		t = 10ms	50% V_{RRM} reapplied		
		t = 8.3ms			
Maximum I^2t for fusing	I^2t	t = 10ms	No voltage reapplied	Sinusoidal half wave, initial $T_J = T_J$ maximum	kA ² s
		t = 8.3ms			
		t = 10ms	50% V_{RRM} reapplied		
		t = 8.3ms			
Maximum $I^2\sqrt{t}$ for fusing	$I^2\sqrt{t}$	t = 0.1 to 10 ms, no voltage reapplied		28800	kA ² √s
Low level value of threshold voltage	$V_{F(TO)1}$	$(16.7\% \times \pi \times I_{F(AV)} < I < \pi \times I_{F(AV)})$, $T_J = T_J$ maximum		0.89	V
High level value of threshold voltage	$V_{F(TO)2}$	$(I > \pi \times I_{F(AV)})$, $T_J = T_J$ maximum		1.02	
Low level value of forward slope resistance	r_{t1}	$(16.7\% \times \pi \times I_{F(AV)} < I < \pi \times I_{F(AV)})$, $T_J = T_J$ maximum		0.23	mΩ
High level value of forward slope resistance	r_{t2}	$(I > \pi \times I_{F(AV)})$, $T_J = T_J$ maximum		0.21	
Maximum forward voltage drop	V_{FM}	$I_{pk} = 4000A$, $T_J = T_J$ maximum, $t_p = 10$ ms sinusoidal wave		1.65	V

THERMAL AND MECHANICAL SPECIFICATIONS					
PARAMETER	SYMBOL	TEST CONDITIONS		VALUES	UNIT
Maximum junction operating temperature range	T_J			-40 to 150	°C
Maximum storage temperature range	T_{stg}			-55 to 200	
Maximum thermal resistance, junction to heatsink	R_{thJ-hs}	DC operation single side cooled		0.042	K/W
		DC operation double side cooled		0.020	
Mounting force, ±10%				22250 (2250)	N (kg)
Approximate weight				425	g
Case style		TO-200AC (K-PUK), Nell's D-type Cap			

△ R_{thJC} CONDUCTION						
CONDUCTION ANGEL	SINUSOIDAL CONDUCTION		RECTANGULAR CONDUCTION		TEST CONDUCTIONS	UNITS
	SINGLE SIDE	DOUBLE SIDE	SINGLE SIDE	DOUBLE SIDE		
180°	0.002	0.002	0.001	0.001	$T_J = T_J$ maximum	K/W
120°	0.002	0.002	0.002	0.002		
90°	0.003	0.003	0.003	0.003		
60°	0.004	0.004	0.004	0.004		
30°	0.007	0.007	0.007	0.007		

Note

- The table above shows the increment of thermal resistance R_{thJ-hs} when devices operate at different conduction angles than DC

Fig.1 Current ratings characteristics

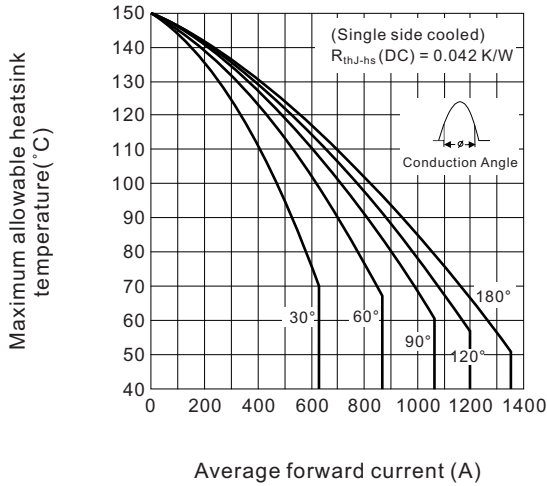

Fig.2 Current ratings characteristics

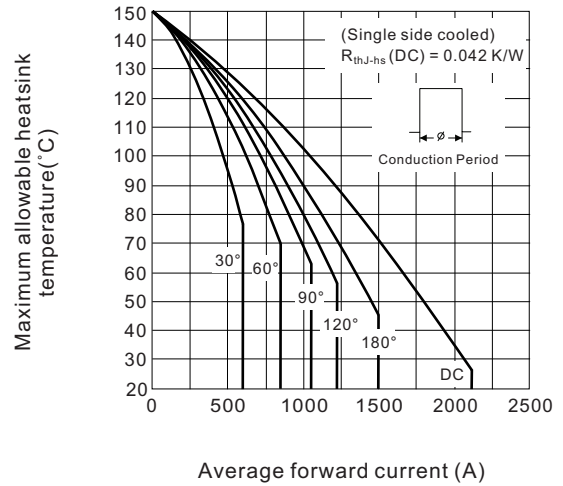

Fig.3 Current ratings characteristics

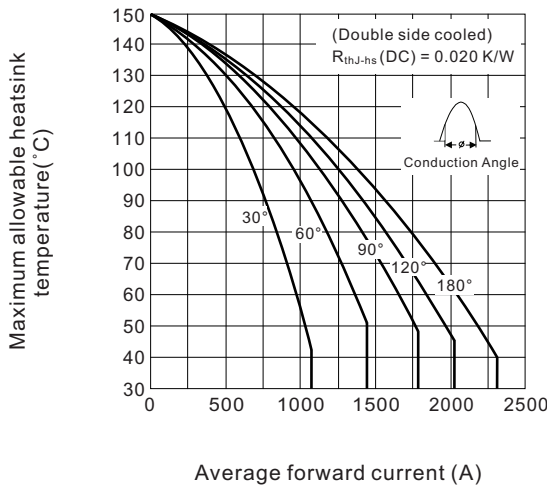

Fig.4 Current ratings characteristics

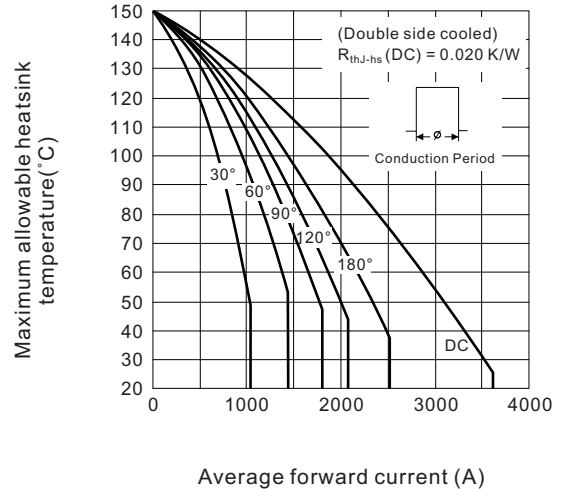

Fig.5 Forward power loss characteristics

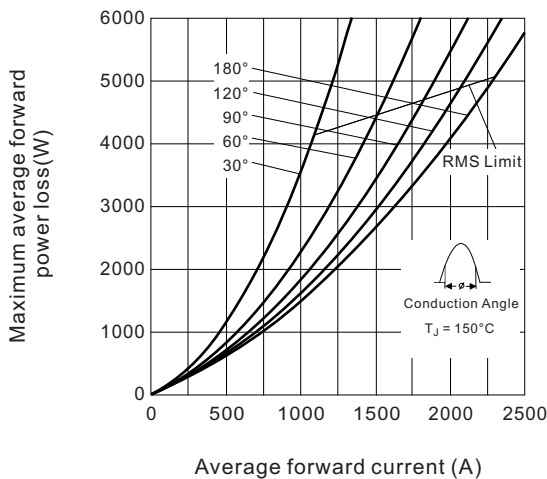

Fig.6 Forward power loss characteristics

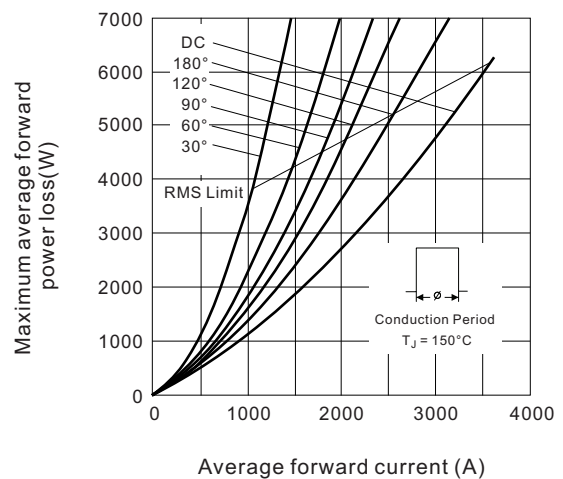

Fig.7 Maximum non-repetitive surge current single and double side cooled

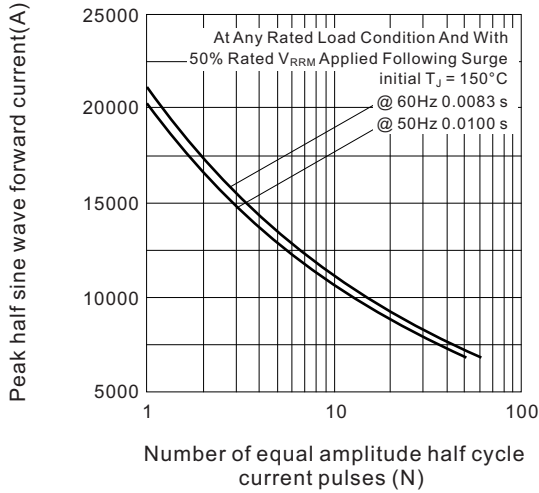

Fig.8 Maximum non-repetitive surge current single and double side cooled

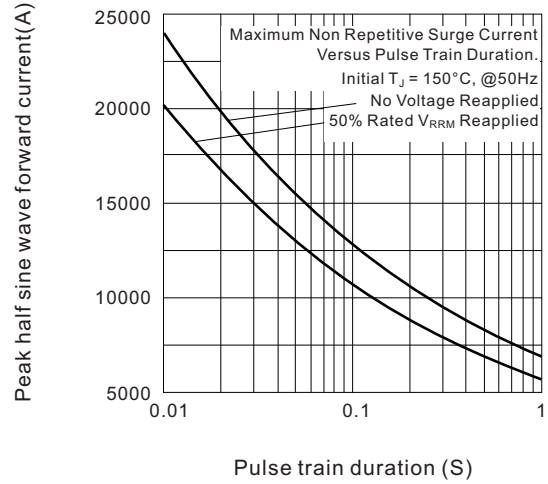

Fig.9 Forward voltage drop characteristics

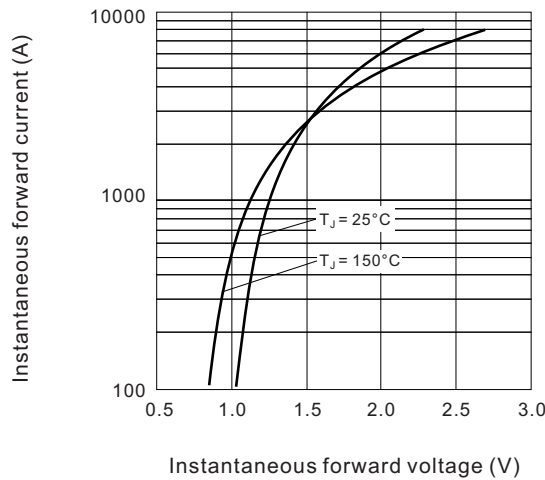
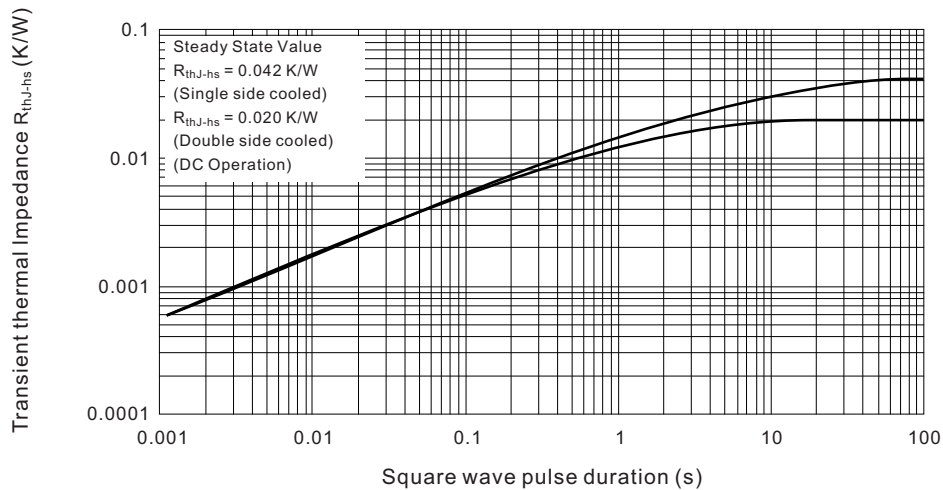

Fig.10 Thermal Impedance R_{thJ-hs} characteristics



ORDERING INFORMATION TABLE

Device code	D	2140	D	30
	①	②	③	④

- ① - "D" for standard recovery diode
- ② - Maximum average forward current, "2140" for 2140A
- ③ - Case style : "D" for Nell's D-type Cap, DO-200AC (K-PUK)
- ④ - Voltage code, code x 100 = V_{RRM}

DO-220AC (K-PUK), Nell's D-type Cap

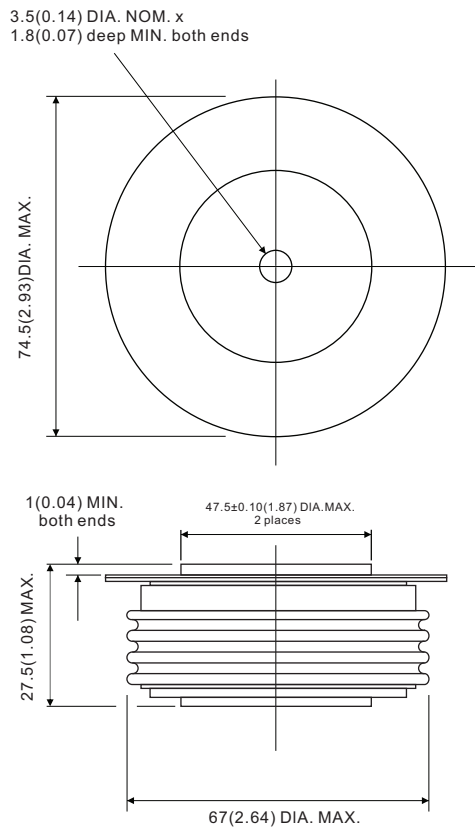

All dimensions in millimeters (inches)

