

# S Series Multifunction DAQ

## 16-Bit, 250 kS/s/Channel, 8 Analog Inputs

### NI 6143

- 8 differential 16-bit analog inputs
- 250 kS/s per channel analog input
- Simultaneous sampling
- 8 digital I/O lines (5 V TTL/CMOS); two 24-bit counter/timers
- Digital triggering
- $\pm 5$  V analog input signal range
- Measurement services that simplify configuration and measurements

### Operating Systems

- Windows 2000/NT/XP
- Mac OS X
- Linux

### Recommended Software

- LabVIEW 7.x or higher
- LabWindows/CVI 7.x or higher
- Measurement Studio 7.x or higher
- SignalExpress 1.x or higher

### Other Compatible Software

- VI Logger 2.x or higher
- Visual Studio .NET
- Visual Basic, C/C++, and C#

### Measurement Services Software (included)<sup>1</sup>

- NI-DAQmx driver
- Measurement & Automation Explorer configuration utility
- VI Logger Lite data-logging software

<sup>1</sup>Mac OS X and Linux applications must use NI-DAQmx Base driver software.

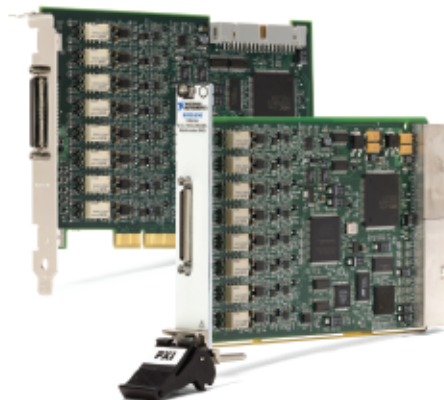

Calibration Certificate Available

Family	Bus	Analog Inputs	Input Resolution	Sampling Rate	Input Range	Digital I/O	Counter/Timers	Trigger
NI 6143	PCI, PXI	8	16 bits	250 kS/s per channel	$\pm 5$ V	8	2, 24-bit	Digital

Table 1. Channel, Speed, and Resolution Specifications

## Overview and Applications

National Instruments 6143 devices combine the latest in PC technologies to deliver simultaneous sampling for high-channel-count applications at a low cost. Use these devices in a variety of applications, including:

- High-energy physics
- Ultrasonic and sonar testing
- Ballistics and highly transient signals
- Multiaxis control

## Features

These devices fall into the NI S Series product family. The S stands for simultaneous sampling, the most evident benefit of the dedicated analog-to-digital converter (ADC) per channel architecture. However, the architecture has a few less obvious but very important advantages.

**Dedicated ADCs per Channel** – This architecture offers a much higher sampling rate per channel. Traditional data acquisition devices share the sampling rate among the number of active channels. The overall data throughput stays the same. With S Series devices, the aggregate throughput increases with the number of active channels.

**Better Dynamic Specifications** – Because each channel has a dedicated ADC, there is less concern with settling time and the noise and error caused by switching input channels. You can tune the analog input path for both accurate DC and dynamic measurements. Traditional data acquisition devices are ideal for DC measurements, but are not always the best solution for dynamic measurements.

**Low-Cost** – The decrease in price of ADCs over time has made a dedicated ADC per channel architecture cost-effective.

## Ordering Information

NI PCI-6143 .....778913-01  
 NI PXI-6143 .....779063-01  
 Includes data acquisition driver software.

## BUY NOW!

For complete product specifications, pricing, and accessory information, call (800) 813 3693 (U.S. only) or go to [ni.com/dataacquisition](http://ni.com/dataacquisition).

# S Series Multifunction DAQ

## 16-Bit, 250 kS/s/Channel, 8 Analog Inputs

### Multichannel Control

For applications that require multichannel simultaneous control, such as multi-axis control systems, an NI 6143 paired with an NI 6733 analog output device is a low-cost, high-performance control solution. When coupled together with LabVIEW Real-Time, these devices are capable of deterministic performance at speeds exceeding 20 kHz for eight parallel PID loops. This control system architecture effectively meets today's demands but also grows with future requirements. As your control algorithms change, you can implement simple to advanced control strategies in LabVIEW Real-Time without breaking the connection to your I/O. Furthermore, as your system I/O requirements change, simply add more I/O to the existing system without significantly modifying your control code.

### Professional Analysis and Presentation Toolkits

There are several analysis and presentation add-on toolkits available from National Instruments that help make you more productive when developing custom applications with your S Series devices. Turn your S Series device into a transient recorder, spectrum analyzer, or one of several other instruments with these toolkits.

### NI LabVIEW Sound and Vibration Toolkit

This toolkit includes a full set of frequency-domain analysis and presentation tools required for sound and vibration applications. These tools include:

- Distortion, gain, phase, cross-talk, and dynamic range measurements
- Octave analysis
- Swept-sine analysis
- Linear, exponential and peak hold measurements
- Baseband and zoom FFT, power, FFT, power spectral density (PSD)
- Limit testing
- Short-time Fourier transform and shock response spectrum
- Weighting filters
- System calibration
- Waterfall/colormap display

### NI LabVIEW Signal Processing Toolkit

This toolkit is a suite of software tools, example programs, and utilities for time-frequency analysis and digital filter design. The toolkit includes:

- Wavelet and filter-bank design
- Digital filter design of FIR and IIR filters
- Joint time-frequency analysis (JTFA) with the Gabor spectrograph
- High-frequency resolution model-based spectral estimation for small datasets

### NI Spectral Measurements Toolkit

This toolkit includes all of the analysis and presentation tools to convert your S Series device into a full-featured spectrum analyzer. The toolkit includes:

- Measurements such as in-band power and adjacent-channel power
- 3D spectrogram
- Analog modulation and demodulation
- I-Q data for digital demodulation
- Highly optimized FFT processing

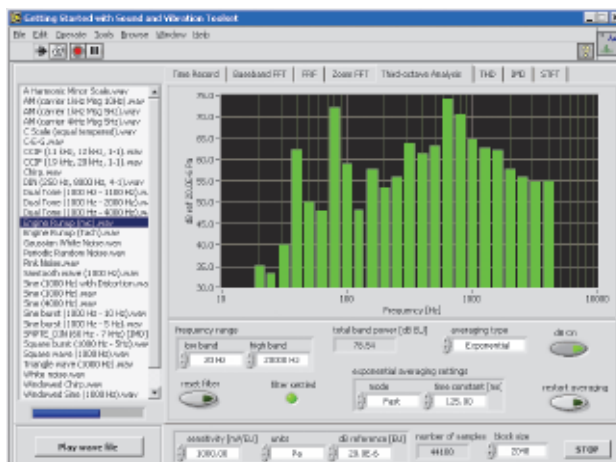

Figure 1. Sound and Vibration Toolkit

### High-Performance Data Throughput

Using NI-DAQmx driver software and S Series, you can take full advantage of your PC's throughput potential, which is useful in many applications including transient recording.

### Flexible Data Transfer

With NI-DAQmx, you can choose where to accumulate data – on the onboard memory, PC RAM memory, or PC hard drive memory. Thus, you can balance your PC application requirements and stream-to-disk/memory capabilities. In any case, NI-DAQmx optimizes data transfers by using DMA (direct memory access) and transferring large chunks of data, while ensuring no data loss. You can also choose the format of your data, further optimizing throughput. Choices include raw (binary), scaled, or the high-level waveform data type. Using these techniques, you can achieve rates of more than 40 MS/s sustained over the PCI/PXI bus to hard drive (depending on the PC).

# S Series Multifunction DAQ

## 16-Bit, 250 kS/s/Channel, 8 Analog Inputs

### Data Compaction

With the release of NI-DAQmx 7.4 or later, data compaction is available for stream-to-disk applications. The NI-DAQmx compaction feature strips unused or unwanted bits of data from each sample taken from your S Series device before it is permanently recorded to hard disk. This is helpful because hard drives are typically the throughput bottleneck compared to the PCI/PXI bus and PC RAM memory read/write speed. Using data compression, users with standard hard drives can see up to 20 percent higher throughput when streaming-to-disk.

### Signal Conditioning

With the release of NI-DAQmx 7.4 or later, all S Series devices are compatible with parallel-mode SCXI modules.

Model	Description	Channels
SCXI-1520	Universal Strain Gage Input	8
SCXI-1125	Isolation Amplifier	8
SCXI-1141/2/3	8-Pole Lowpass Filters	8

Table 2. Most Popular Parallel-Mode SCXI Modules

SCXI is limited to 100 kS/s for 16-bit accuracy and 333 kS/s for 12-bit accuracy when used in multiplexed mode. However, in parallel mode, the sample rate is limited by the maximum scan rate of the data acquisition device. When SCXI is used in parallel mode with S Series, all channels are simultaneously sampled and the sample rate is limited by the S Series device, from 250 kS/s per channel to 10 MS/s per channel.

### Measurement Services Software

National Instruments measurement services software, built around NI-DAQmx driver software, includes intuitive application programming interfaces, configuration tools, I/O assistants, and other tools designed to reduce system setup, configuration, and development time. This software is included with your data acquisition purchase. Helpful features include:

**Automatic Code Generation** – DAQ Assistant is an interactive guide that helps you navigate through configuring, testing, and programming measurement tasks and generates the necessary code automatically for LabVIEW, LabWindows/CVI, or Measurement Studio.

**Cleaner Code Development** – Basic and advanced software functions have been combined into one easy-to-use yet powerful set to help you build cleaner code and move from basic to advanced applications without replacing functions.

**High-Performance Driver Engine** – NI-DAQ delivers maximum I/O system throughput with a multithreaded driver.

**Test Panels** – With the Measurement & Automation Explorer configuration utility, you can test all of your device functionality before you begin development.

**Scaled Channels** – Easily scale your voltage data into the proper engineering units using the NI-DAQ Measurement Ready virtual channels by choosing from a list of common sensors and signals or creating your own custom scale.

**Data-Logging Software** – VI Logger Lite is configuration-based software designed specifically for data logging. Features include easy logging and viewing of data, data extraction to Microsoft Excel, and code generation in LabVIEW.

**LabVIEW Integration** – All NI-DAQ functions create the waveform data type, which carries acquired data and timing information directly into more than 400 LabVIEW built-in analysis routines for display of results in engineering units on a graph.

### NI-DAQmx Base Driver

NI-DAQmx Base (available at [ni.com/downloads](http://ni.com/downloads)) offers Mac OS X and Linux users a programming interface similar to NI-DAQmx. It includes ready-to-use LabVIEW VIs and C function features similar to those included in NI-DAQmx driver software.

# S Series Multifunction DAQ

## 16-Bit, 250 kS/s/Channel, 8 Analog Inputs

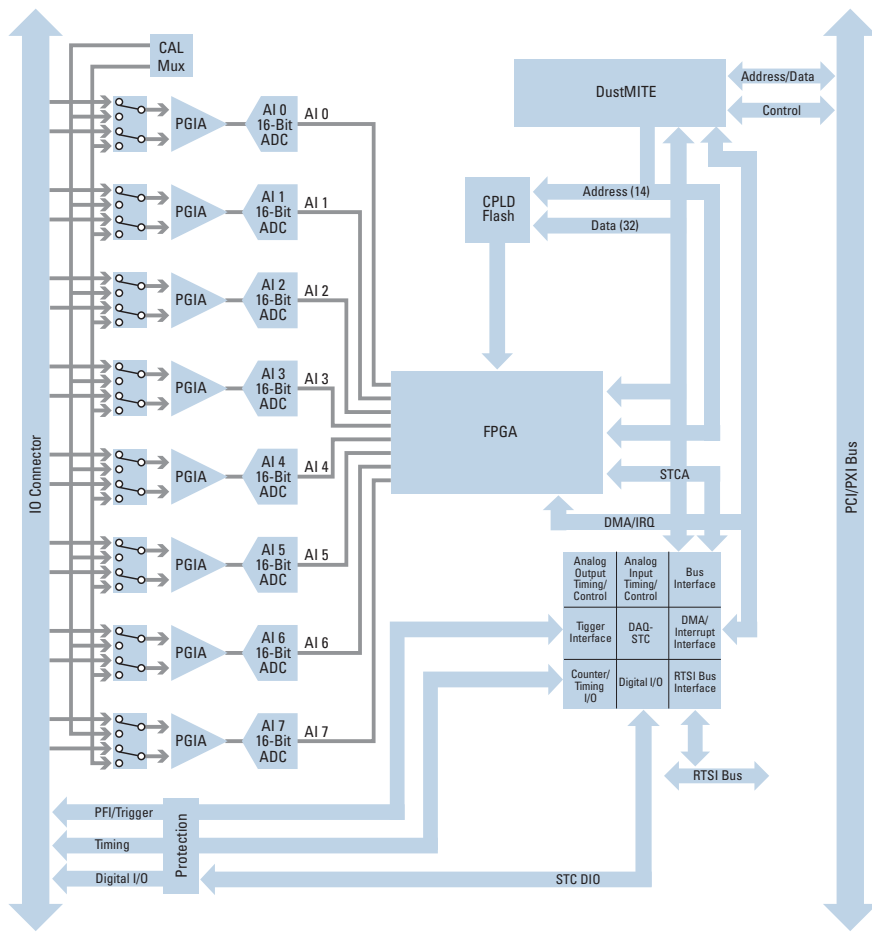
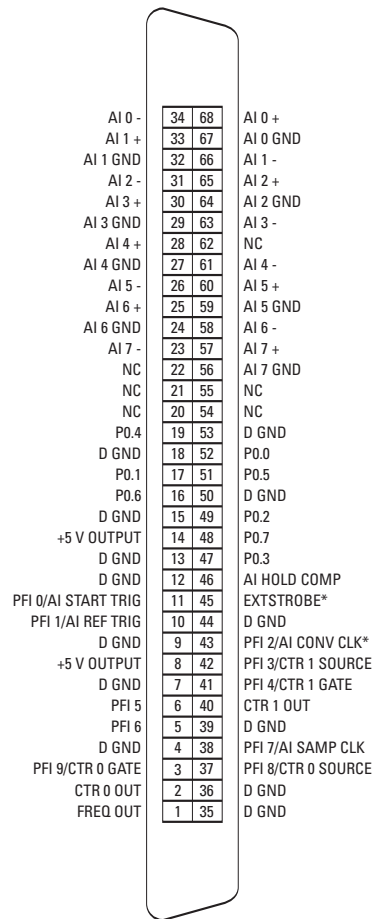

Figure 2. Block Diagram



NC = No Connect

Figure 3. I/O Connector

# S Series Multifunction DAQ

## Specifications

The following specifications are typical at 25 °C unless otherwise noted.

### Analog Input

Input Characteristics	
Number of channels .....	8 differential
ADC resolution .....	16 bits, 1 in 65,536
Sampling rate	
Maximum .....	250 kS/s
Minimum .....	0 S/s
Input coupling .....	DC
Input range .....	±5 V
Input FIFO size .....	2,046 samples
Data transfers .....	DMA, interrupts, programmed I/O
DMA mode .....	Scatter-gather

### Digital I/O

Number of channels .....	8 input/output
Compatibility .....	TTL/CMOS
Power-on state .....	Input (high-impedance)
Data transfers .....	DMA, interrupts, programmed I/O

### Timing I/O

Counter/Timers	
Number of channels .....	2 up/down counter/timers
Resolution .....	24 bits
Compatibility .....	TTL/CMOS

### Digital Trigger

Purpose .....	Start, reference, and pause trigger; sample clock
External sources .....	PFI <0..9>, RTSI <0..6>
Compatibility .....	TTL
Response .....	Rising or falling edge
Pulse width .....	10 ns min

### RTSI Bus (PCI only)

Trigger lines <0..6> .....	7
RTSI clock .....	1

### PXI Trigger Bus (PXI only)

Trigger lines <0..5> .....	6
Star trigger .....	1
Clock .....	1

### Physical

Dimensions (not including connectors) .....	15.5 by 10.6 cm (6.10 by 4.17 in.)
I/O connector .....	68-pin VHDCI

# S Series Multifunction DAQ Cables and Accessories

## Recommended Configurations

I/O Configuration	Accessory	Cable
Shielded Option	SCB-68 (776844-01)	SHC68-68-EP (186838-01)
Unshielded Option	CB-68LPR (777145-02)	RC68-68 (187252-01)
BNC Option	BNC-2110 (777643-01)	SHC68-68-EP (186838-01)

### SHC68-68-EP Noise-Rejecting, Shielded Cable

This cable connects the NI 6143 devices directly to 68-pin accessories. Latching screws secure the shielded connector to the NI 6143. The SHC68-68-EP is a shielded 68-conductor cable terminated with a VHDCI 68-pin male connector at one end and a 68-pin female 0.050 series D-type connector at the other.

SHC68-68-EP

0.5 m .....186838-0R5  
 1 m .....186838-01

### RC68-68 Low-Cost Ribbon Cable

The RC68-68 cable connects the NI 6143 devices directly to 68-pin accessories.

0.25 m .....187252-0R25  
 1 m .....187252-01

### SCB-68 Noise-Rejecting, Shielded I/O Connector Block

The SCB-68 is a shielded I/O connector block for rugged, very-low-noise signal termination for connecting 68-pin S Series DAQ devices, such as NI 6143. Silk-screened component locations provide an easy addition of simple signal-conditioning circuitry for your analog input channels. It also includes a general-purpose breadboard area as well as an IC temperature sensor for cold-junction compensation in temperature measurements.

SCB-68 .....776844-01  
 Dimensions – 19.5 by 15.2 by 4.5 cm (7.7 by 6.0 by 1.8 in.)

### CB-68LP and CB-68LPR Low-Cost I/O Connector Blocks

The CB-68LP and CB-68LPR are low-cost termination accessories with 68 screw terminals for easy connection of field I/O signals to 68-pin DAQ devices, such as NI 6143. They include one 68-pin male connector for direct connection to 68-pin cables. The connector blocks include standoffs for use on a desktop or for mounting in a custom panel. The CB-68LP has a vertical-mounted 68-pin connector. The CB-68LPR has a right-angle mounted connector, and it is used with the CA-1000.

CB-68LP .....777145-01  
 Dimensions – 14.35 by 10.74 cm (5.65 by 4.23 in.)  
 CB-68LPR .....777145-02  
 Dimensions – 7.62 by 16.19 cm (3.00 by 6.36 in.)

### BNC-2110 Noise-Rejecting BNC I/O Connector Block

The BNC-2110 is a shielded connector block with signal-labeled BNC connectors for easy connectivity of your analog input, digital I/O, and counter/timer signals.

BNC-2110 .....777643-01  
 Dimensions – 20.3 by 11.2 by 5.5 cm (8.0 by 4.4 by 2.2 in.)



SHC68-68-EP Noise-Rejecting, Shielded Cable

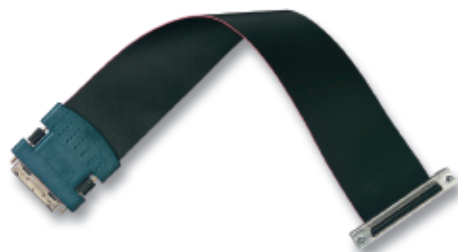

RC68-68 Low-Cost Ribbon Cable



SCB-68 Noise-Rejecting, Shielded I/O Connector Block

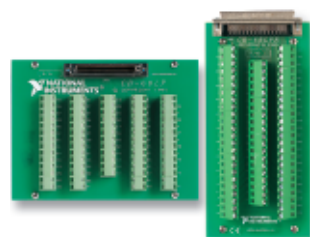

CB-68LP and CB-68LPR Low-Cost I/O Connector Blocks



BNC-2110 I/O Connector Block

# NI Services and Support

NI has the services and support to meet your needs around the globe and through the application life cycle – from planning and development through deployment and ongoing maintenance. We offer services and service levels to meet customer requirements in research, design, validation, and manufacturing. Visit [ni.com/services](http://ni.com/services).

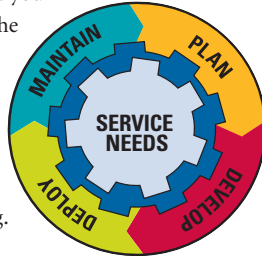

## Training and Certification

NI training is the fastest, most certain route to productivity with our products. NI training can shorten your learning curve, save development time, and reduce maintenance costs over the application life cycle. We schedule instructor-led courses in cities worldwide, or we can hold a course at your facility. We also offer a professional certification program that identifies individuals who have high levels of skill and knowledge on using NI products. Visit [ni.com/training](http://ni.com/training).

## Professional Services

Our Professional Services Team is comprised of NI applications engineers, NI Consulting Services, and a worldwide National Instruments Alliance Partner program of more than 600 independent consultants and integrators. Services range from start-up assistance to turnkey system integration. Visit [ni.com/alliance](http://ni.com/alliance).



## OEM Support

We offer design-in consulting and product integration assistance if you want to use our products for OEM applications. For information about special pricing and services for OEM customers, visit [ni.com/oem](http://ni.com/oem).

## Local Sales and Technical Support

In offices worldwide, our staff is local to the country, giving you access to engineers who speak your language. NI delivers industry-leading technical support through online knowledge bases, our applications engineers, and access to 14,000 measurement and automation professionals within NI Developer Exchange forums. Find immediate answers to your questions at [ni.com/support](http://ni.com/support).

We also offer service programs that provide automatic upgrades to your application development environment and higher levels of technical support. Visit [ni.com/ssp](http://ni.com/ssp).

## Hardware Services

### NI Factory Installation Services

NI Factory Installation Services (FIS) is the fastest and easiest way to use your PXI or PXI/SCXI combination systems right out of the box. Trained NI technicians install the software and hardware and configure the system to your specifications. NI extends the standard warranty by one year on hardware components (controllers, chassis, modules) purchased with FIS. To use FIS, simply configure your system online with [ni.com/pxiadvisor](http://ni.com/pxiadvisor).

### Calibration Services

NI recognizes the need to maintain properly calibrated devices for high-accuracy measurements. We provide manual calibration procedures, services to recalibrate your products, and automated calibration software specifically designed for use by metrology laboratories. Visit [ni.com/calibration](http://ni.com/calibration).

### Repair and Extended Warranty

NI provides complete repair services for our products. Express repair and advance replacement services are also available. We offer extended warranties to help you meet project life-cycle requirements. Visit [ni.com/services](http://ni.com/services).



[ni.com](http://ni.com) • (800) 813 3693

National Instruments • [info@ni.com](mailto:info@ni.com)