

Package: T-Package, 12.7mm x 12.7mm x 3.96mm

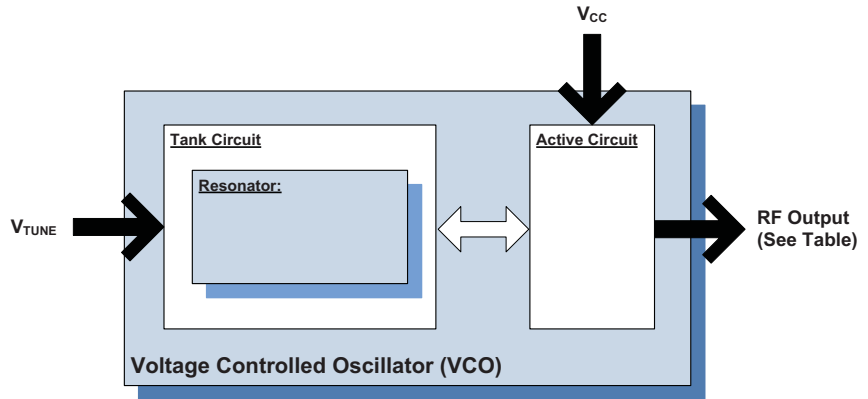

**Features**

- Linear Tuning/Low Phase Noise
- Multiple Supply Voltage and Package Options Available
- Low-Cost/High-Volume Series
- Frequency: 2200MHz to 2350MHz
- Resonator: Aircoil or Microstrip
- PCB: FR-4 and S1170
- Package Size: 12.7mm x 12.7mm x 3.96mm (0.5in x 0.5in x 0.156in)



Functional Block Diagram

**Applications**

- Wireless Infrastructure
- RFID
- General Wireless

**Product Description**

This series of narrowband, low-cost, 5V VCO modules offers linear tuning across their specified frequency band.

**Ordering Information**

VC0190-2275TY      Contact us at 1-480-756-6070

**Optimum Technology Matching® Applied**

- |                                      |                                      |  |                                    |
|--------------------------------------|--------------------------------------|--|------------------------------------|
| <input type="checkbox"/> GaAs HBT    | <input type="checkbox"/> SiGe BiCMOS | <input type="checkbox"/> GaAs pHEMT        | <input type="checkbox"/> GaN HEMT  |
| <input type="checkbox"/> GaAs MESFET | <input type="checkbox"/> Si BiCMOS   | <input type="checkbox"/> Si CMOS           | <input type="checkbox"/> BiFET HBT |
| <input type="checkbox"/> InGaP HBT   | <input type="checkbox"/> SiGe HBT    | <input checked="" type="checkbox"/> Si BJT | <input type="checkbox"/> LD MOS    |

RF MICRO DEVICES®, RFMD®, Optimum Technology Matching®, Enabling Wireless Connectivity™, PowerStar®, POLARIS™ TOTAL RADIO™ and UltimateBlue™ are trademarks of RFMD, LLC. BLUETOOTH is a trademark owned by Bluetooth SIG, Inc., U.S.A. and licensed for use by RFMD. All other trade names, trademarks and registered trademarks are the property of their respective owners. ©2012, RF Micro Devices, Inc.

## Absolute Maximum Ratings

Parameter	Rating	Unit
Operating Ambient Temperature	-40 to +85	°C
Storage Temperature	-55 to +125	°C



**Caution!** ESD sensitive device.

Exceeding any one or a combination of the Absolute Maximum Rating conditions may cause permanent damage to the device. Extended application of Absolute Maximum Rating conditions to the device may reduce device reliability. Specified typical performance or functional operation of the device under Absolute Maximum Rating conditions is not implied.

The information in this publication is believed to be accurate and reliable. However, no responsibility is assumed by RF Micro Devices, Inc. ("RFMD") for its use, nor for any infringement of patents, or other rights of third parties, resulting from its use. No license is granted by implication or otherwise under any patent or patent rights of RFMD. RFMD reserves the right to change component circuitry, recommended application circuitry and specifications at any time without prior notice.



RoHS (Restriction of Hazardous Substances): Compliant per EU Directive 2002/95/EC.

Parameter	Specification			Unit	Condition
	Min.	Typ.	Max.		
<b>Overall</b>					
Frequency Range	2200		2350	MHz	
Tuning Voltage	1	2		V <sub>DC</sub>	2200MHz
		8	10	V <sub>DC</sub>	2350MHz
Tuning Sensitivity	15	30	40	MHz/V	
Output Power	2	5	8	dBm	
Output Phase Noise		-122	-116	dBc/Hz	100kHz
Harmonic Suppression		-15	-10	dBc	2nd harmonic
		-20	-10	dBc	3rd harmonic
Spurious (Non-Harmonic)			-90	dBc	
Frequency Pushing		1	3	MHz p-p	4.9V to 5.1V
Frequency Pulling		3	5	MHz p-p	12dB RL
Tuning Port Capacitance		15		pF	
Output Impedance		50		Ω	
<b>Power Supply</b>					
Operating Voltage	4.9	5	5.1	V	
Supply Current		15	40	mA	

**Package Drawing & Pin Outs**

12.7mm x 12.7mm x 3.96mm (0.5in x 0.5in x 0.156in)

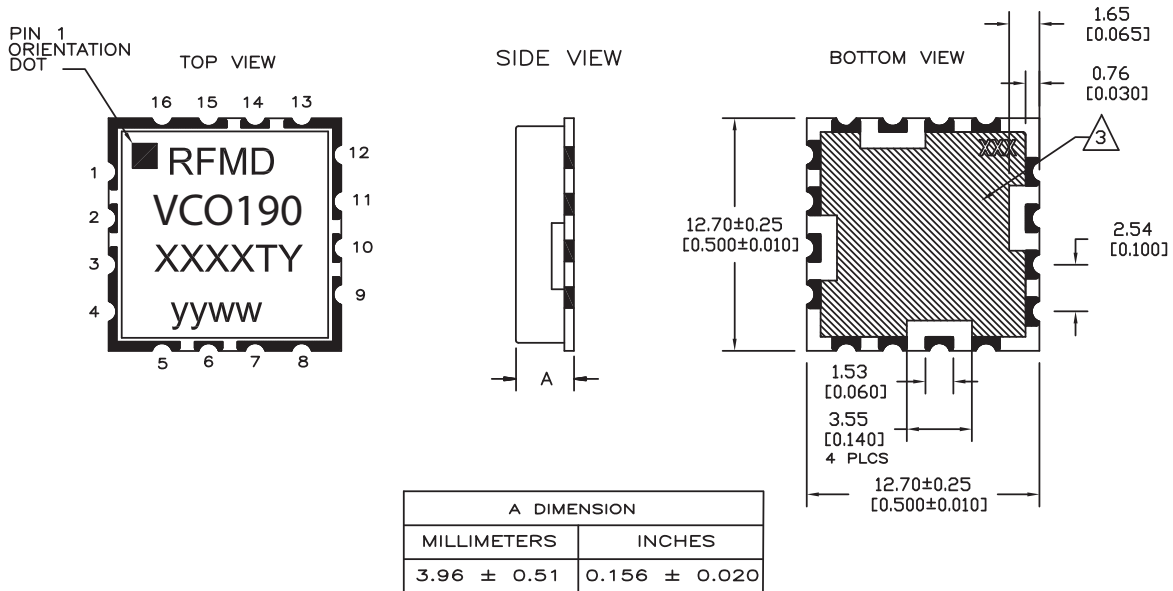

PIN OUT FOR VCO	
PIN	APPLICATION
2	Vt
6	MODULATION (OPT)
10	RF OUT
14	VCC

ALL OTHER PINS ARE GROUND

NOTE, UNLESS OTHERWISE SPECIFIED:

1. THE METAL CASE IS GROUND.
2. ALL HALF VIA CONTACTS ARE PLATED THRU FROM THE PAD ON THE TOP SIDE TO THE PAD ON THE BOTTOM SIDE OF THE BOARD.
3. HATCHED AREAS ARE GROUND AND ARE COVERED WITH LPI SOLDER MASK OVER BARE COPPER. ALL CONTACT AREAS ARE PLATED. SIGNAL VIAS MAY BE LOCATED WITHIN GROUND PLANE.
4. CROSS HATCHED AREA INDICATES AREA WHERE SOLDER MASK SHOULD BE APPLIED TO MOUNTING BOARD.
5. XXXX REPRESENTS THE MODEL NUMBER.
6. yyww IS THE DATE CODE.
7. Y AT THE END OF THE MODEL NUMBER DESIGNATES RoHS COMPLIANCE.
8. DIMENSIONS ARE IN MILLIMETERS AND [INCHES].