

## SP6T GaAs Multi-Band GSM Antenna Switch

### Features:

- ◆ Available in die form
- ◆ Suitable for multi-band GSM/DCS/PCS/EDGE applications
- ◆ Excellent low control voltage performance
- ◆ Excellent harmonic performance under GSM/DCS/PCS power levels
- ◆ Very high Tx-Rx isolation >45dB typ. at 1.8GHz
- ◆ Very high Tx-Tx isolation >30dB typ. at 1.8GHz
- ◆ Very low Tx Insertion loss
- ◆ Very low control current

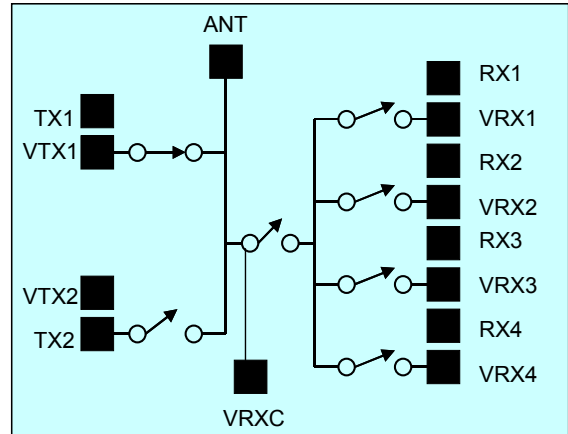

### Description and Applications:

The FMS2010 is a low loss, high power and linear single pole six throw Gallium Arsenide antenna switch designed for use in mobile handset applications. The die is fabricated using the Filtronic FL05 0.5 $\mu$ m switch process technology that offers leading edge performance optimised for switch applications. The FMS2010 is designed for use in dual, tri and quad – band GSM handset antenna switch modules and RF front-end modules.

### Electrical Specifications: ( $T_{\text{AMBIENT}} = 25^{\circ}\text{C}$ , $V_{\text{control}} = 0\text{V}/2.5\text{V}$ , $Z_{\text{IN}} = Z_{\text{OUT}} = 50\Omega$ )

Parameter	Test Conditions	Min	Typ	Max	Units
Tx Insertion Loss	0.5 – 1.0 GHz	—	0.5	0.7	dB
	1.0 – 2.0 GHz	—	0.6	0.9	dB
Rx Insertion Loss	0.5 – 1.0 GHz	—	0.6	0.8	dB
	1.0 – 2.0 GHz	—	0.8	1.2	dB
Return Loss	0.5 – 2.5 GHz	—	23	—	dB
Isolation TX-TX	0.5 – 1.0 GHz	30	33	—	dB
	1.0 – 2.0 GHz	25	31	—	dB
Isolation TX-RX	0.5 – 1.0 GHz	45	50	—	dB
	1.0 – 2.0 GHz	40	45	—	dB
2nd Harmonic Level	1 GHz, Pin = +35 dBm, 100% Duty Cycle	—	-75	-70	dBc
	2 GHz, Pin = +33 dBm, 100% Duty Cycle (17:1 VSWR)	—	-75	-70	dBc
3rd Harmonic Level	1 GHz, Pin = +35 dBm, 100% Duty Cycle	—	-75	-70	dBc
	2 GHz, Pin = +33 dBm, 100% Duty Cycle (17:1 VSWR)	—	-75	-70	dBc
Switching speed : Trise, Tfall Ton, Toff	10% to 90% RF and 90% to 10% RF	—	< 0.3	—	$\mu$ s
	50% control to 90% RF and 50% control to 10% RF	—	< 1.0	—	$\mu$ s

**Note:** External DC blocking capacitors are required on all RF ports (typ: 100pF).  
All unused ports terminated in 50 $\Omega$ .

**Absolute Maximum Ratings:**

Parameter	Absolute Maximum
Max Input Power	+38dBm
Control Voltage	+8.5V
Operating Temp	-40 °C to 100°C
Storage Temp	-55 °C to 150°C

**Note:** Exceeding any one of these absolute maximum ratings may cause permanent damage to the device.

**Truth Table:**

VRXC	VRX4	VTX2	VRX3	VRX1	VRX2	VTX1	ON PATH
Low	Low	Low	Low	Low	Low	High	ANT-TX1
Low	Low	High	Low	Low	Low	Low	ANT-TX2
High	Low	Low	Low	High	Low	Low	ANT-RX1
High	Low	Low	Low	Low	High	Low	ANT-RX2
High	Low	Low	High	Low	Low	Low	ANT-RX3
High	High	Low	Low	Low	Low	Low	ANT-RX4

**Note:**

'High' = +2.5V to +5V  
 'Low' = 0V to +0.2V

**Pad and Die Layout:**

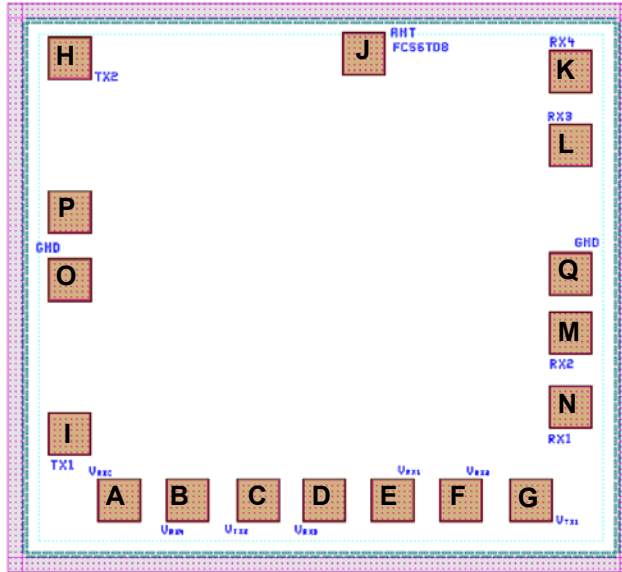

Pad Number	Pad Name	Description	Pin Coordinates (µm)
A	VRXC	Common Receive Switch Control Voltage	195, 126
B	VRX4	RX4 Control Voltage	315, 126
C	VTX2	TX2 Control Voltage	440, 126
D	VRX3	RX3 Control Voltage	556, 126
E	VRX1	RX1 Control Voltage	675, 126
F	VRX2	RX2 Control Voltage	795, 126
G	VTX1	TX1 Control Voltage	919, 126
H	TX2	TX2 RF Output	108, 904
I	TX1	TX1 RF Output	108, 242
J	ANT	Antenna	474, 912
K	RX4	RX4 RF Output	988, 880
L	RX3	RX3 RF Output	988, 750
M	RX2	RX2 RF Output	988, 420
N	RX1	RX1 RF Output	988, 290
O	GND	Ground 1	108, 514
P	GND	Ground 2	108, 627
Q	GND	Ground 3	988, 525

**Note:** Co-ordinates are referenced from the bottom left hand corner of the die to the centre of the bond pad opening

Die Size (µm)	Die Thickness (µm)	Min. Bond Pad Pitch(µm)	Min. Bond pad opening (µm)
1100 x 1000	150 µm	113	70 x 70

Typical Measured Performance Curves:

**TX Loss**

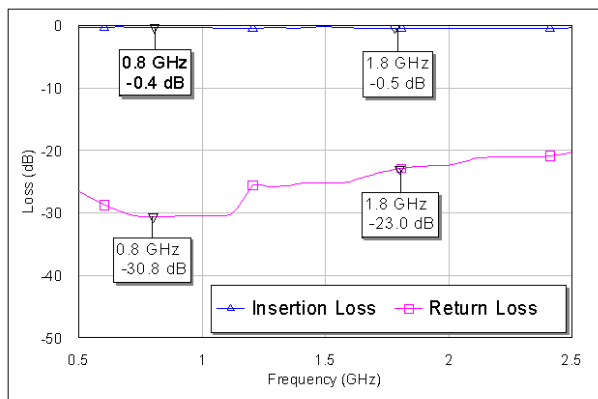

**RX Loss**

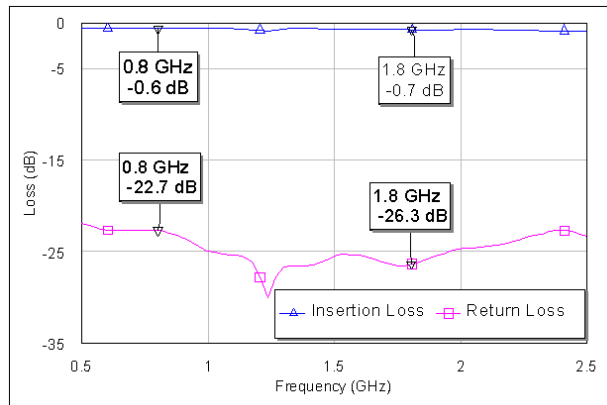

**TX-TX Isolation**

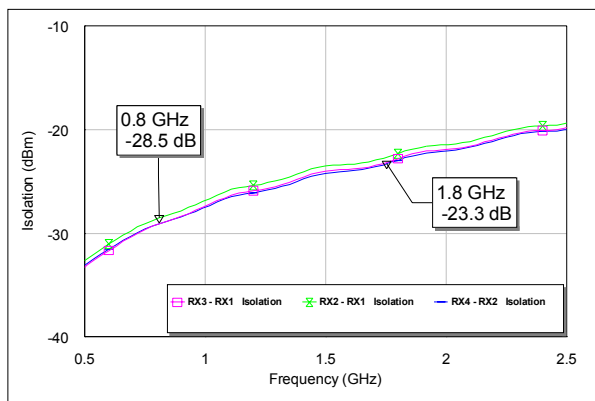

**RX-RX Isolation**

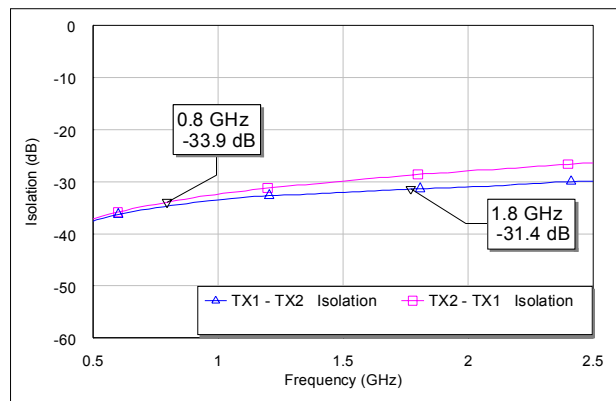

**TX-RX Isolation**

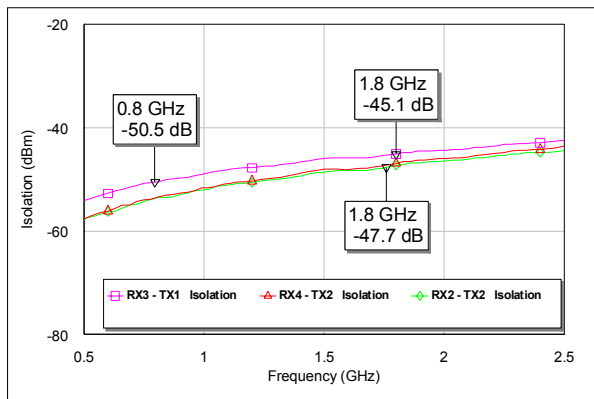

**TX Harmonic Level**

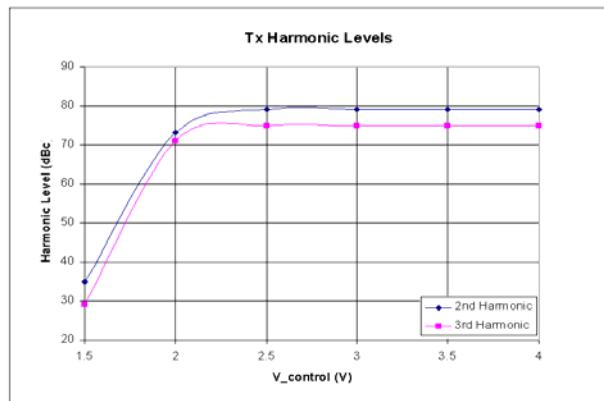

**Evaluation Board:**

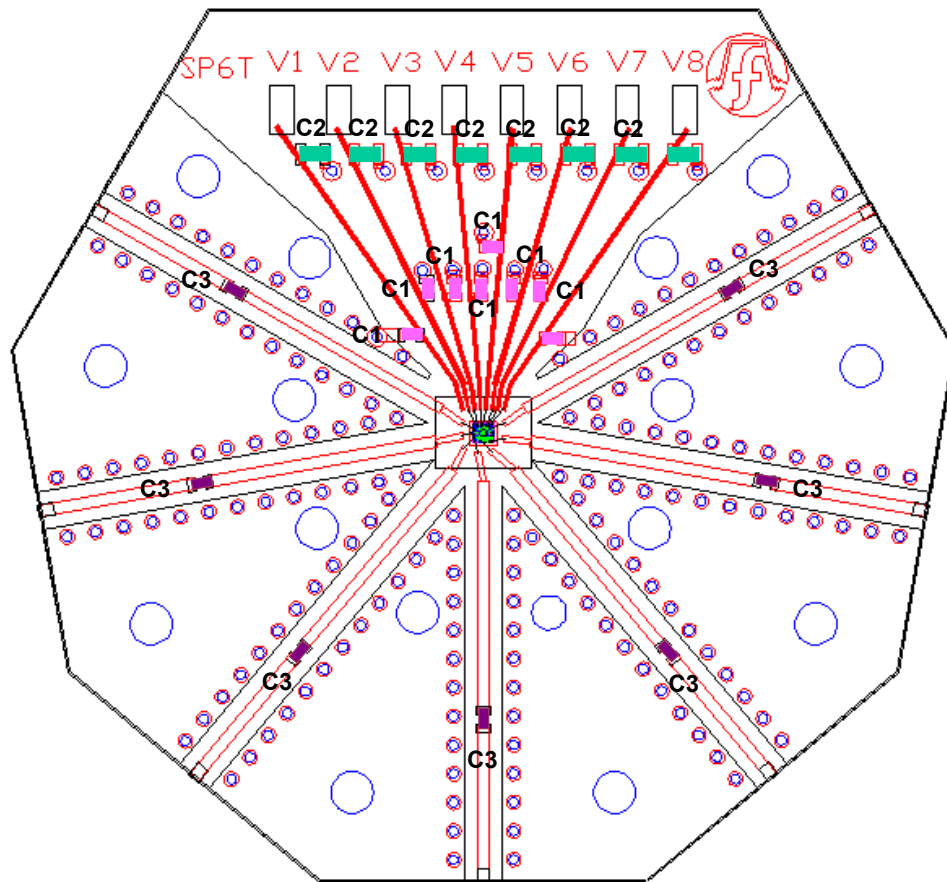

**BOM**

Label	Component
C1	Capacitor, 47pF, 0402
C2	Capacitor, 470pF, 0603
C3	Capacitor, 100pF, 0402

**Ordering Information:**

Part Number	Description
FMS2010-000-WP	Die – waffle pak
FMS2010-000-GP	Die – gel-pak
FMS2010-000-EB	Die mounted on evaluation board
FMS2010-000-FF	Wafer mounted on film frame

**Preferred Assembly Instructions:**

GaAs devices are fragile and should be handled with great care. Specially designed collets should be used where possible.

The back of the die is not metallised and the recommended mounting method is by the use of conductive epoxy. Epoxy should be applied to the attachment surface uniformly and sparingly to avoid encroachment of epoxy on to the top face of the die and ideally should not exceed half the chip height. For automated dispense Ablestick LMISR4 is recommended and for manual dispense Ablestick 84-1 LMI or 84-1 LMIT are recommended. These should be cured at a temperature of 150°C for 1 hour in an oven especially set aside for epoxy curing only. If possible the curing oven should be flushed with dry nitrogen.

This part has gold (Au) bond pads requiring the use of gold (99.99% pure) bondwire. It is recommended that 25.4µm diameter gold wire is used. Thermosonic ball bonding is preferred. A nominal stage temperature of 150°C and a bonding force of 40g has been shown to give effective results for 25µm wire. Ultrasonic energy shall be kept to a minimum. For this bonding technique, stage temperature should not be raised above 200°C and bond force should not be raised above 60g. Thermosonic wedge bonding and thermocompression wedge bonding can also be used to achieve good wire bonds.

Bonds should be made from the die first and then to the mounting substrate or package. The physical length of the bondwires should be minimised especially when making RF or ground connections.

**Handling Precautions:**

To avoid damage to the devices care should be exercised during handling. Proper Electrostatic Discharge (ESD) precautions should be observed at all stages of storage, handling, assembly, and testing. These devices should be treated as Class 1A (0-500 V) as defined in JEDEC Standard No. 22-A114-B. Further information on ESD control measures can be found in MIL-STD-1686 and MIL-HDBK-263.

**Disclaimers:**

This product is not designed for use in any space based or life sustaining/supporting equipment.