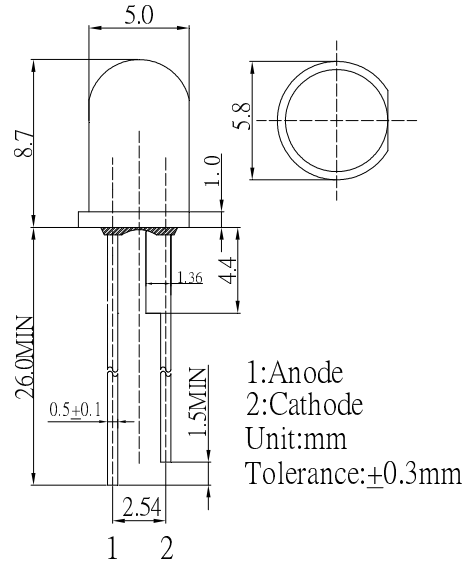

**■ Features**

- High Luminous LEDs
- 5mm Round Standard Directivity
- Superior Weather-resistance
- UV Resistant Epoxy
- Water Clear Type

**■ Applications**

- Traffic signal, Portable light source
- Signage and channel letter
- Decorating and entertainment lighting
- Architectural lighting
- Outdoor/Indoor applications/Other Lighting

**■ Outline Dimension**

**■ Absolute Maximum Rating**
**(Ta=25°C)**

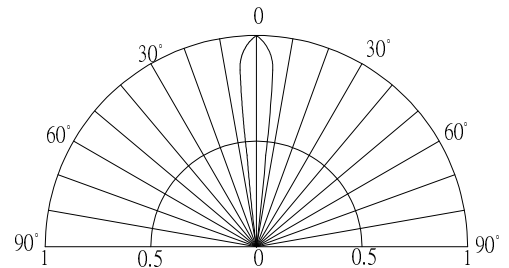
Item	Symbol	Value	Unit
DC Forward Current	$I_F$	70	mA
Pulse Forward Current*	$I_{FP}$	120	mA
Reverse Voltage	$V_R$	5	V
Power Dissipation	$P_D$	182	mW
Operating Temperature	$T_{opr}$	-30 ~ +85	°C
Storage Temperature	$T_{stg}$	-40 ~ +100	°C
Lead Soldering Temperature	$T_{sol}$	260°C / 5sec	-

**■ Directivity**

\*Pulse width Max.10ms Duty ratio max 1/10

**■ Electrical -Optical Characteristics**
**(Ta=25°C)**

Item	Symbol	Condition	Min.	Typ.	Max.	Unit
DC Forward Voltage	$V_F$	$I_F=60mA$	2.0	2.2	2.6	V
DC Reverse Current	$I_R$	$V_R=5V$	-	-	10	$\mu A$
Domi. Wavelength*	$\lambda_D$	$I_F=60mA$	585	590	595	nm
Luminous Intensity*	$I_v$	$I_F=60mA$	60000	75000	-	mcd
50% Power Angle	$2\theta_{1/2}$	$I_F=60mA$	-	15	-	deg

 \*1 Tolerance of dominant wavelength is  $\pm 1nm$ 

 \*2 Tolerance of luminous intensity is  $\pm 15\%$ 
**■ Maximum Forward DC Current**
