

# DC-DC Converter UNIT

KW Series ( 15 W WIDE INPUT RANGE DC-DC CONVERTER )

## FEATURES

- 15W DIL PACKAGE
- 9-18V,18-36V,36-72V WIDE INPUT RANGE
- SHORT CIRCUIT PROTECTION
- LOW COST
- NO EXTERNAL COMPONENTS REQUIRED
- REGULATED OUTPUT
- TYPICAL EFFICIENCY 80%
- 100% BURNED IN
- INDUSTRY STANDARD PACKAGE
- MTBF > 700,000 HOURS



### ● OUTPUT SPECIFICATIONS

Voltage Setpoint Accuracy	+/-3% max
Temperature Coefficient	+/-0.03%/°C
Ripple & Noise (20MHz BW)	100mVp-p max
Line Regulation <sup>1</sup>	+/-0.2% max
Load Regulation <sup>2</sup>	+/-0.2% max
Short Circuit Protection	Continuous

### ● ENVIRONMENTAL SPECIFICATIONS

Operating Temperature	-25°C to +71°C
Storage Temperature	-55°C to +100°C
Cooling	Free-Air Convection

ALL SPECIFICATIONS TYPICAL AT NOMINAL LINE, FULL LOAD , AND 25 °C UNLESS OTHERWISE NOTED.

### ● INPUT SPECIFICATIONS

Input Voltage Range	2:1 INPUT RANGE
Input Filter	Pi Network

### ● GENERAL SPECIFICATIONS

Efficiency	70% min
Isolation Voltage <sup>3</sup>	1000 VDC min
Isolation Resistance	10 <sup>9</sup> ohms min
Switching Frequency	200 KHz min
MTBF	700,000 Hours
Weight	60.0g Typ
Case Material	Six-Side Shielded Case
Case Size	50.8mm*50.8mm*11mm

<sup>1</sup> High Line to Low Line.

<sup>2</sup> Load Regulation is for output load current change from 10% to 100%.

<sup>3</sup> For 10 seconds

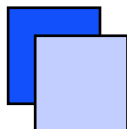

# DC-DC Converter UNIT

KW Series ( 15 W WIDE INPUT RANGE DC-DC CONVERTER )

## ● SELECTION GUIDE(1) 2:1 15W OUTPUT

MODEL NUMBER	INPUT VOLTAGE (VDC)	OUTPUT VOLTAGE (VDC)	OUTPUT CURRENT (mA)	INPUT <sup>4</sup>		EFF (%) <sup>5</sup>	ISOLATION (VDC)
				CURRENT(mA)			
				FULL LOAD	NO LOAD		
KWS-1205	9-18	5	3000	1623	40	77	1000
KWS-1209	9-18	9	1670	1580	30	79	1000
KWS-1212	9-18	12	1250	1563	40	80	1000
KWS-1215	9-18	15	1000	1545	38	81	1000
KWS-1224	9-18	24	625	1543	38	81	1000
KWD-1205	9-18	+/-5	+/-1500	1623	40	77	1000
KWD-1212	9-18	+/-12	+/-625	1563	40	80	1000
KWD-1215	9-18	+/-15	+/-500	1525	38	82	1000
KWD-1224	9-18	+/-24	+/-313	1510	38	83	1000
KWS-2405	18-36	5	3000	780	20	80	1000
KWS-2412	18-36	12	1250	762	18	82	1000
KWS-2415	18-36	15	1000	762	18	82	1000
KWS-2424	18-36	24	625	753	18	83	1000
KWD-2405	18-36	+/-5	+/-1500	750	20	83	1000
KWD-2412	18-36	+/-12	+/-625	762	18	82	1000
KWD-2415	18-36	+/-15	+/-500	753	18	83	1000
KWD-2424	18-36	+/-24	+/-313	750	20	83	1000
KWS-4805	36-72	5	3000	396	10	79	1000
KWS-4812	36-72	12	1250	381	9	82	1000
KWS-4815	36-72	15	1000	381	9	82	1000
KWS-4824	36-72	24	625	375	9	83	1000
KWD-4805	36-72	+/-5	+/-1500	375	10	83	1000
KWD-4812	36-72	+/-12	+/-625	381	9	82	1000
KWD-4815	36-72	+/-15	+/-500	381	9	82	1000
KWD-4824	36-72	+/-24	+/-313	375	9	83	1000

*Note: Other input to output voltages may be available. Please contact factory.*

<sup>4</sup> NOMINAL INPUT VOLTAGE.

<sup>5</sup> NOMINAL INPUT VOLTAGE, FULL LOAD.

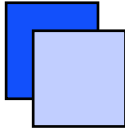

# DC-DC Converter UNIT

KW Series ( 15 W WIDE INPUT RANGE DC-DC CONVERTER )

## ● SELECTION GUIDE(2) 4:1 15W OUTPUT

MODEL NUMBER	INPUT VOLTAGE (VDC)	OUTPUT VOLTAGE (VDC)	OUTPUT CURRENT (Ma)	INPUT <sup>6</sup> CURRENT(mA)		EFF (%) <sup>7</sup>	ISOLATION (VDC)
				FULL LOAD	NO LOAD		
				KWS-1205T	9-36		
KWS-1209T	9-36	9	1670	1600	30	78	1000
KWS-1212T	9-36	12	1250	1562	40	80	1000
KWS-1215T	9-36	15	1000	1562	38	80	1000
KWS-1224T	9-36	24	625	1562	28	80	1000
KWD-1205T	9-36	+/-5	+/-1500	1623	40	77	1000
KWD-1212T	9-36	+/-12	+/-625	1562	40	80	1000
KWD-1215T	9-36	+/-15	+/-500	1562	38	80	1000
KWS-2405T	18-72	5	3000	791	20	79	1000
KWS-2412T	18-72	12	1250	771	18	81	1000
KWS-2415T	18-72	15	1000	762	18	82	1000
KWD-2405T	18-72	+/-5	+/-1500	791	20	79	1000
KWD-2412T	18-72	+/-12	+/-625	771	18	81	1000
KWD-2415T	18-72	+/-15	+/-500	762	18	82	1000

*Note: Other input to output voltages may be available. Please contact factory.*

<sup>6</sup> NOMINAL INPUT VOLTAGE.

<sup>7</sup> NOMINAL INPUT VOLTAGE, FULL LOAD.

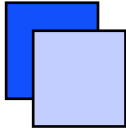

# DC-DC Converter UNIT

KW Series ( 15 W WIDE INPUT RANGE DC-DC CONVERTER )

## ● SIMPLIFIED SCHEMATIC

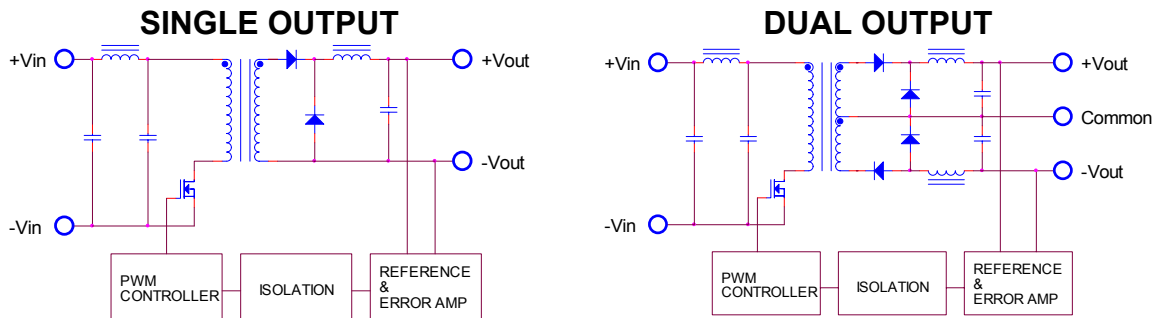

## ● MECHANICAL DIMENSIONS

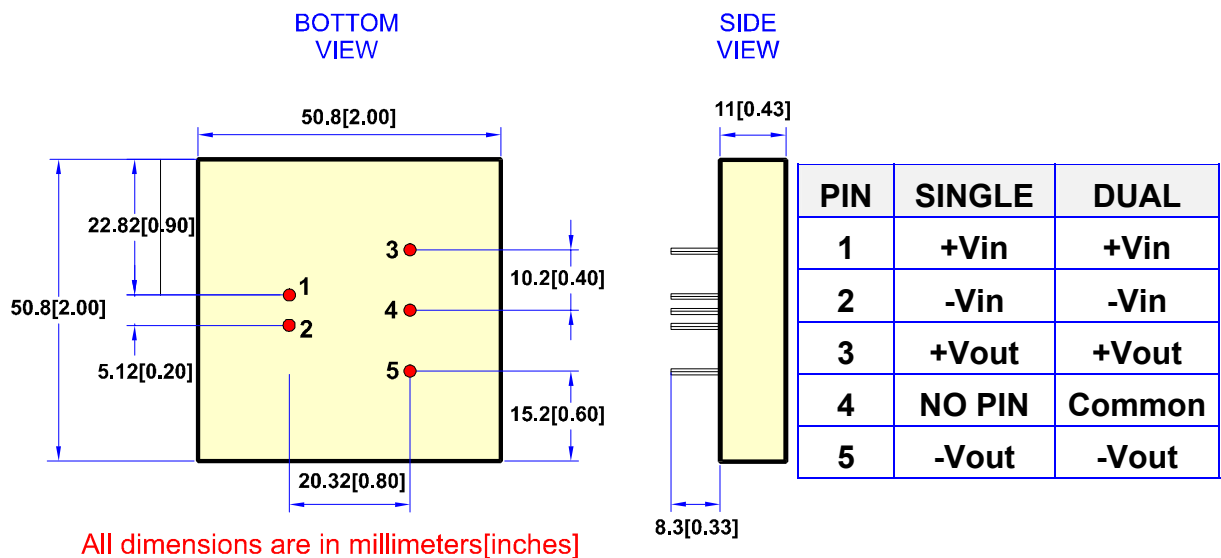

## ● RECOMMENDED FOOTPRINT DETAILS

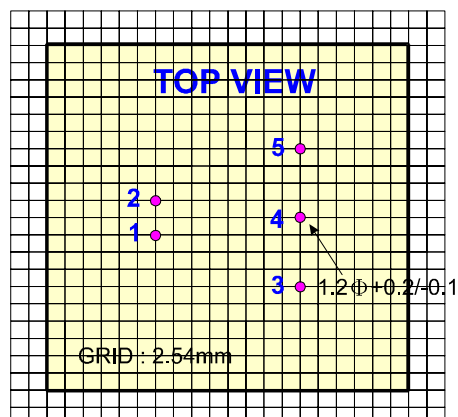

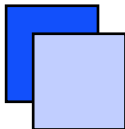

# DC-DC Converter UNIT

KW Series ( 15 W WIDE INPUT RANGE DC-DC CONVERTER )

## ● TYPICAL APPLICATIONS

### SINGLE OUTPUT

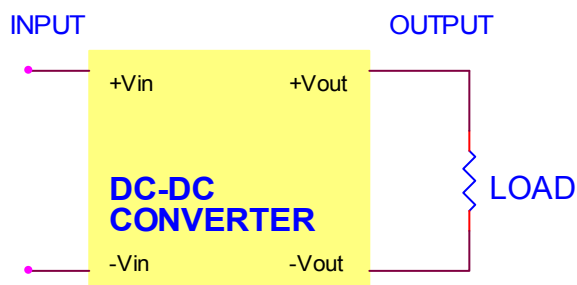

### DUAL OUTPUT

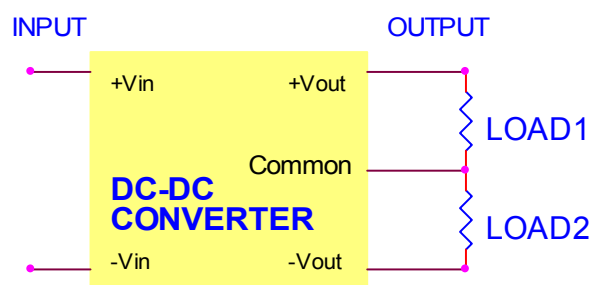

## ● TEMPERATURE DERATING

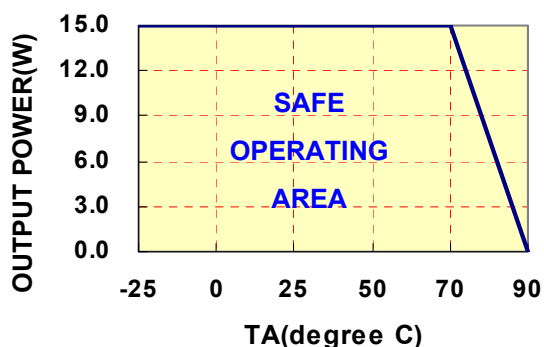

## **KW SERIES APPLICATION NOTES:**

### **EXTERNAL CAPACITANCE REQUIREMENTS:**

No external capacitance is required for operation of the KW series.

To meet the reflected ripple requirements of the converter, an input impedance of less than 0.5 ohm from DC to 220KHz is required.

External output capacitance is not required for operation, however it is recommended that 10uF tantalum and 0.1uF ceramic capacitance be selected for reduced system noise.

Additional output capacitance may be added for increased filtering, but should not exceed 220uF.

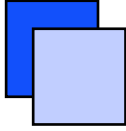

## DC-DC Converter UNIT

---

KW Series ( 15 W WIDE INPUT RANGE DC-DC CONVERTER )

---

### **Negative Outputs:**

A negative output voltage may be obtained by connecting the +OUT to circuit ground and connecting –OUT as the negative output.

---

---

### **FOR MORE INFORMATION CALL:**

#### ***Power Systems – The Power Solution***

Ilfeld-Auenstein ( Germany ) Dörnet 8    Tel: + 49 / 70 62 / 67 59 – 6    Fax: + 49 / 70 62 / 67 59 -80

E-mail: [Info@Power-Systems.de](mailto:Info@Power-Systems.de)    Home Page: [www.Power-Systems.de](http://www.Power-Systems.de)

---

---