

Dual Micropower Single Supply Rail-to-Rail Input and Output (RRIO) Precision Op-Amp

The ISL28278 and ISL28478 are Dual and Quad channel micropower precision operational amplifier optimized for single supply operation at 5V and can operate down to 2.4V. For equivalent performance in a single channel op-amp reference EL8178.

The ISL28278 and ISL28478 feature an Input Range Enhancement Circuit (IREC) which enables both parts to maintain CMRR performance for input voltages equal to the positive and negative supply rails. The input signal is capable of swinging 10% above the positive supply rail and to 100mV below the negative supply with only a slight degradation of the CMRR performance. The output operation is rail to rail.

The both parts draw minimal supply current while meeting excellent DC-accuracy, AC-performance, noise and output drive specifications.

The ISL28278 and ISL28478 can be operated from one lithium cell or two Ni-Cd batteries. The input range includes both positive and negative rail.

Ordering Information

PART NUMBER	PART MARKING	TAPE & REEL	PACKAGE	PKG. DWG. #
ISL28278FAZ (See Note)	28278FAZ	97/Tube	16 Ld QSOP (Pb-free)	MDP0040
ISL28278FAZ-T7 (See Note)	28278FAZ	7" (1000 pcs)	16 Ld QSOP (Pb-free)	MDP0040
Coming Soon ISL28478FAZ (Note)	28478FAZ	97/Tube	16 Ld QSOP (Pb-free)	MDP0040
Coming Soon ISL28478FAZ-T7 (Note)	28478FAZ	7" (1000 pcs)	16 Ld QSOP (Pb-free)	MDP0040

NOTE: Intersil Pb-free plus anneal products employ special Pb-free material sets; molding compounds/die attach materials and 100% matte tin plate termination finish, which are RoHS compliant and compatible with both SnPb and Pb-free soldering operations. Intersil Pb-free products are MSL classified at Pb-free peak reflow temperatures that meet or exceed the Pb-free requirements of IPC/JEDEC J STD-020.

Features

- Low Power 120 μ A typ supply current for both channels
- 225 μ V max offset voltage
- 30pA typ input bias current
- 300kHz gain-bandwidth product
- 100dB typ PSRR and CMRR
- Single supply operation down to 2.4V
- Input is capable of swinging above V+ and below V- (ground sensing)
- Rail-to-rail input and output (RRIO)
- Pb-free plus anneal available (RoHS compliant)

Applications

- Battery- or solar-powered systems
- 4mA to 25mA current loops
- Handheld consumer products
- Medical devices
- Thermocouple amplifiers
- Photodiode pre-amps
- pH probe amplifiers

Pinouts

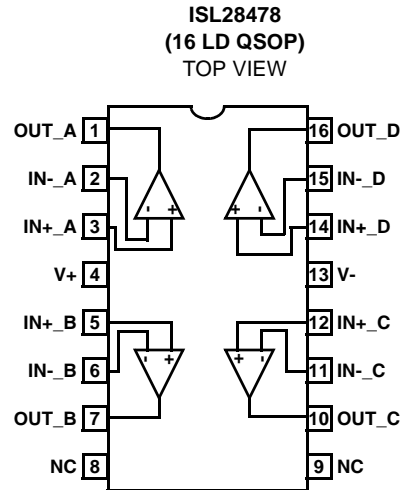
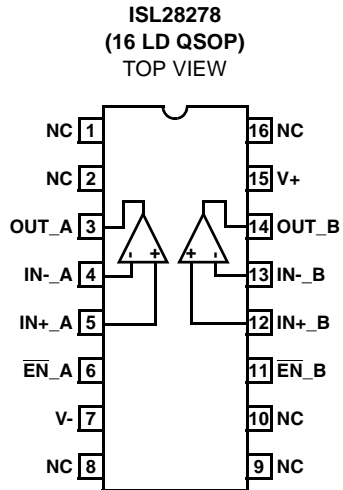

ISL28278, ISL28478

Absolute Maximum Ratings ($T_A = +25^\circ\text{C}$)

Supply Voltage	5.5V	Output Short-Circuit Duration	Indefinite
Supply Turn On Voltage Slew Rate	1V/ μs	Ambient Operating Temperature Range	-40°C to +125°C
Differential Input Current	5mA	Storage Temperature Range	-65°C to +150°C
Differential Input Voltage	0.5V		
Input Voltage	$V_- - 0.5\text{V}$ to $V_+ + 0.5\text{V}$		
ESD tolerance, Human Body Model3kV		
ESD tolerance, Machine Model300V		

CAUTION: Stresses above those listed in "Absolute Maximum Ratings" may cause permanent damage to the device. This is a stress only rating and operation of the device at these or any other conditions above those indicated in the operational sections of this specification is not implied.

IMPORTANT

: All parameters having Min/Max specifications are guaranteed. Typical values are for information purposes only. Unless otherwise noted, all tests are at the specified temperature and are pulsed tests, therefore: $T_J = T_C = T_A$

Electrical Specifications $V_+ = 5\text{V}$, $V_- = 0\text{V}$, $V_{CM} = 2.5\text{V}$, $R_L = 10\text{k}\Omega$, $T_A = +25^\circ\text{C}$ unless otherwise specified. **Boldface limits apply over the operating temperature range, -40°C to +125°C**

PARAMETER	DESCRIPTION	CONDITIONS	MIN	TYP	MAX	UNIT
V_{OS}	Input Offset Voltage		-225 -450	± 20	225 450	μV
$\frac{\Delta V_{OS}}{\Delta \text{Time}}$	Long Term Input Offset Voltage Stability			1.2		$\mu\text{V}/\text{Mo}$
$\frac{\Delta V_{OS}}{\Delta T}$	Input Offset Drift vs Temperature			2.2		$\mu\text{V}/^\circ\text{C}$
I_{OS}	Input Offset Current		-600	± 5	30 600	pA
I_B	Input Bias Current	-40°C to +85°C	-30 -80	± 10	30 80	pA
e_N	Input Noise Voltage Peak-to-Peak	$f = 0.1\text{Hz}$ to 10Hz		5.4		μV_{PP}
	Input Noise Voltage Density	$f_O = 1\text{kHz}$		50		$\text{nV}/\sqrt{\text{Hz}}$
i_N	Input Noise Current Density	$f_O = 1\text{kHz}$		0.14		$\text{pA}/\sqrt{\text{Hz}}$
CMIR	Input Voltage Range	Guaranteed by CMRR test	0		5	V
CMRR	Common-Mode Rejection Ratio	$V_{CM} = 0\text{V}$ to 5V	80 75	100		dB
PSRR	Power Supply Rejection Ratio	$V_+ = 2.4\text{V}$ to 5V	85 80	105		dB
A_{VOL}	Large Signal Voltage Gain	$V_O = 0.5\text{V}$ to 4.5V , $R_L = 100\text{k}\Omega$	200 190	300		V/mV
		$V_O = 0.5\text{V}$ to 4.5V , $R_L = 1\text{k}\Omega$		25		V/mV
V_{OUT}	Maximum Output Voltage Swing	Output low, $R_L = 100\text{k}\Omega$		3	6 30	mV
		Output low, $R_L = 1\text{k}\Omega$		130	175 225	mV
		Output high, $R_L = 100\text{k}\Omega$	4.990 4.97	4.996		V
		Output high, $R_L = 1\text{k}\Omega$	4.800 4.750	4.880		V
SR	Slew Rate		0.12 0.09	± 0.14	0.16 0.21	V/ μs
GBW	Gain Bandwidth Product			300		kHz

Electrical Specifications $V_+ = 5V, V_- = 0V, V_{CM} = 2.5V, R_L = 10k\Omega, T_A = +25^\circ C$ unless otherwise specified.
Boldface limits apply over the operating temperature range, $-40^\circ C$ to $+125^\circ C$ (Continued)

PARAMETER	DESCRIPTION	CONDITIONS	MIN	TYP	MAX	UNIT
$I_{S,ON}$	Supply Current, Enabled	All channels enabled.		120	156 175	μA
$I_{S,OFF}$	Supply Current, Disabled	All channels disabled.		4	7 9	μA
I_{SC+}	Short Circuit Sourcing Capability	$R_L = 10\Omega$	29 24	31		mA
I_{SC-}	Short Circuit Sinking Capability	$R_L = 10\Omega$	24 20	26		mA
V_S	Minimum Supply Voltage		2.4			V
V_{INH}	Enable Pin High Level				2	V
V_{INL}	Enable Pin Low Level		0.8			V
I_{ENH}	Enable Pin Input Current	$V_{EN} = 5V$		0.8	1 1.5	μA
I_{ENL}	Enable Pin Input Current	$V_{EN} = 0V$	-0.1	0	+0.1	μA

Typical Performance Curves

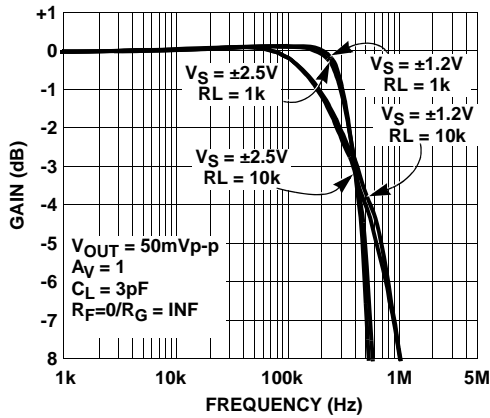

FIGURE 1. FREQUENCY RESPONSE vs SUPPLY VOLTAGE

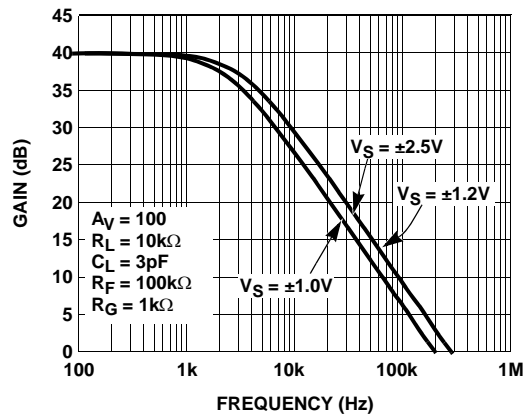

FIGURE 2. FREQUENCY RESPONSE vs SUPPLY VOLTAGE

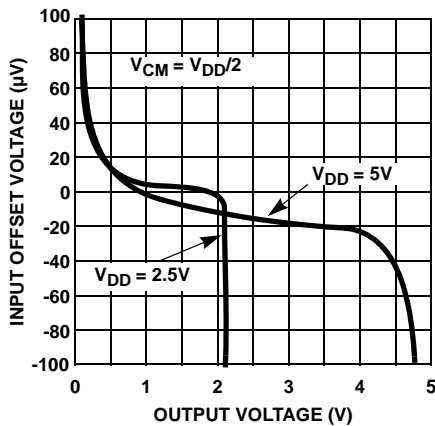

FIGURE 3. INPUT OFFSET VOLTAGE vs OUTPUT VOLTAGE

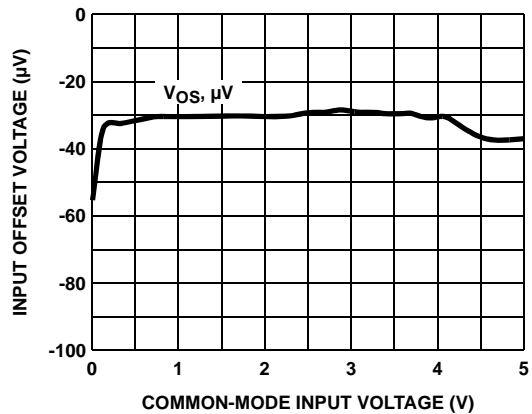

FIGURE 4. INPUT OFFSET VOLTAGE vs COMMON-MODE INPUT VOLTAGE

Typical Performance Curves (Continued)

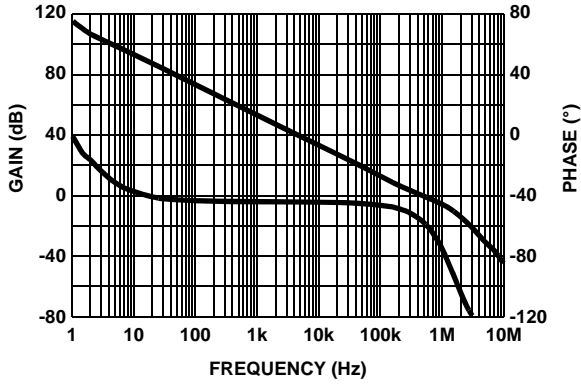

FIGURE 5. A_{VOL} vs FREQUENCY @ 100k Ω LOAD

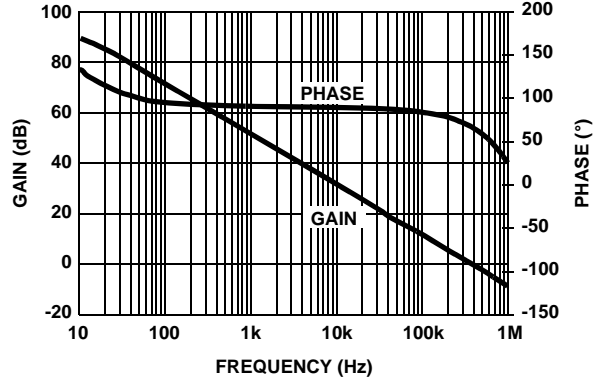

FIGURE 6. A_{VOL} vs FREQUENCY @ 1k Ω LOAD

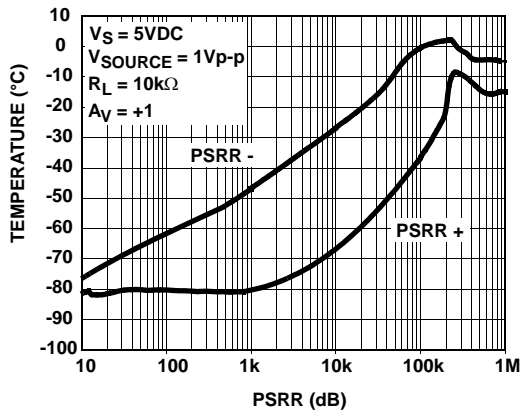

FIGURE 7. PSRR vs FREQUENCY

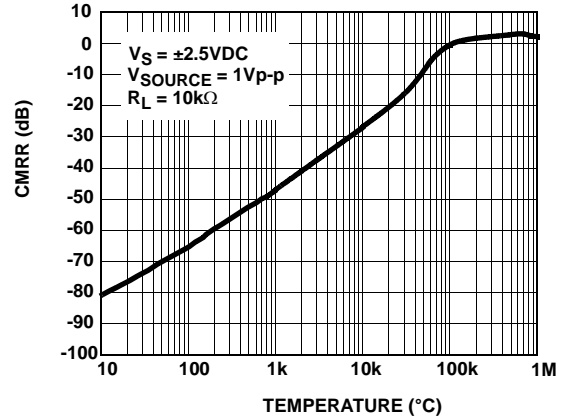

FIGURE 8. CMRR vs FREQUENCY

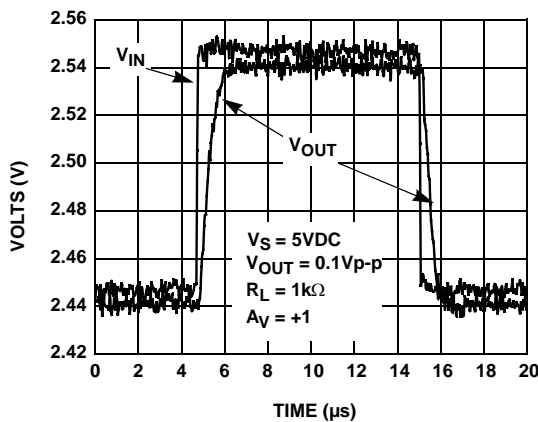

FIGURE 9. SMALL SIGNAL TRANSIENT RESPONSE

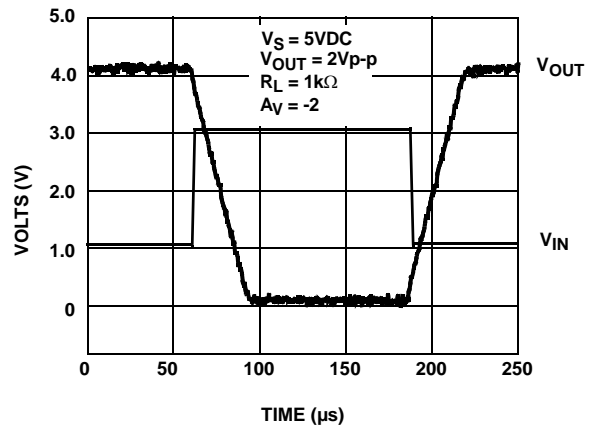

FIGURE 10. LARGE SIGNAL TRANSIENT RESPONSE

Typical Performance Curves (Continued)

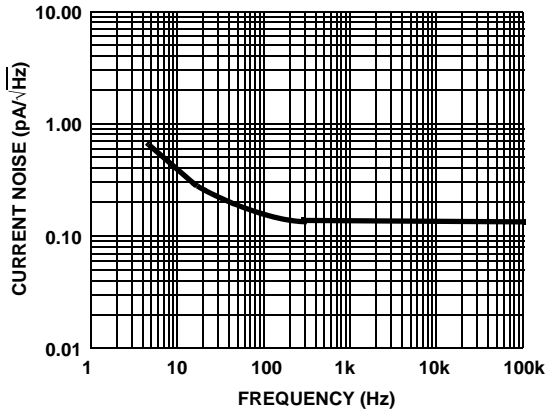

FIGURE 11. CURRENT NOISE vs FREQUENCY

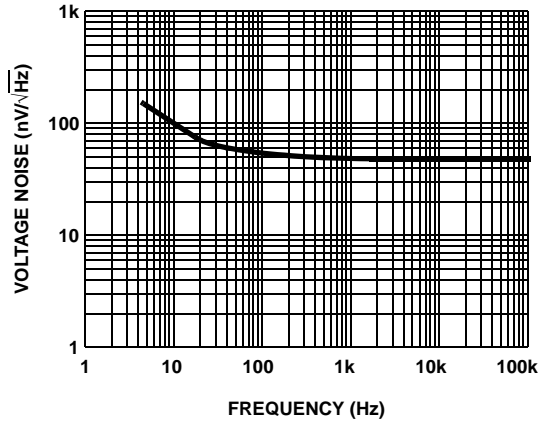

FIGURE 12. VOLTAGE NOISE vs FREQUENCY

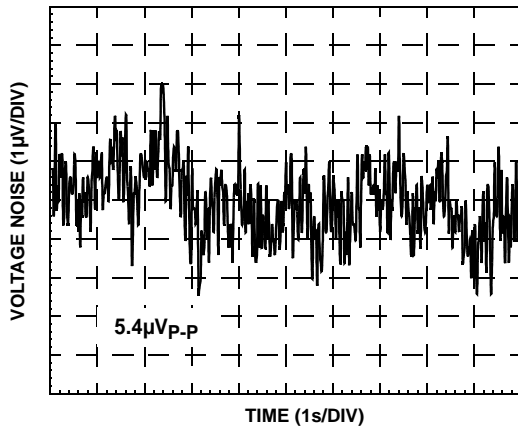

FIGURE 13. 0.1Hz TO 10Hz INPUT VOLTAGE NOISE

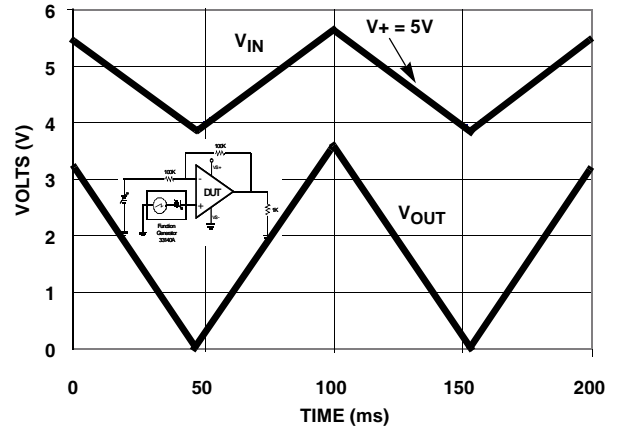

FIGURE 14. INPUT VOLTAGE SWING ABOVE THE V+ SUPPLY

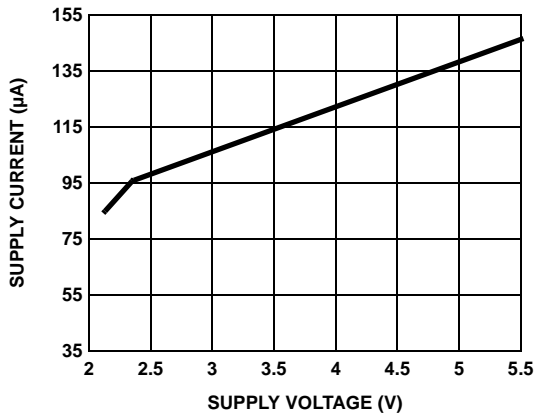

FIGURE 15. SUPPLY CURRENT vs SUPPLY VOLTAGE

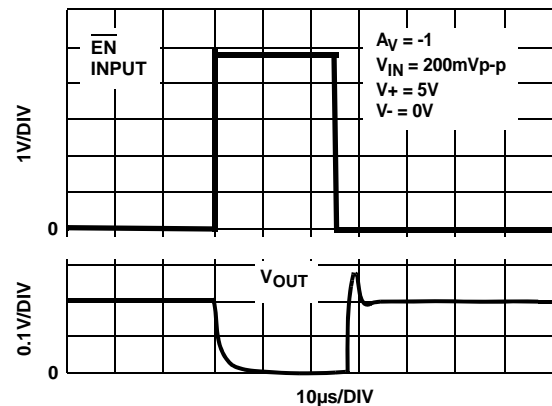

FIGURE 16. ENABLE TO OUTPUT DELAY TIME

Typical Performance Curves (Continued)

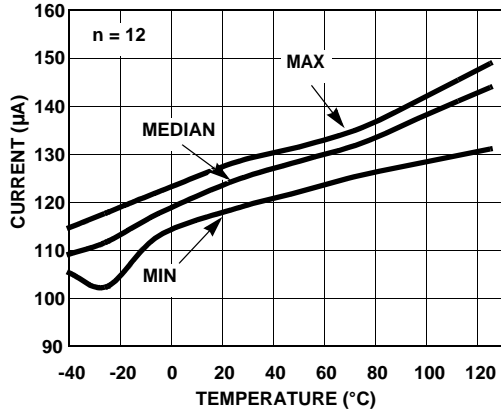

FIGURE 17. SUPPLY CURRENT vs TEMPERATURE $V_S = \pm 2.5V$ ENABLED, $R_L = \text{INF}$

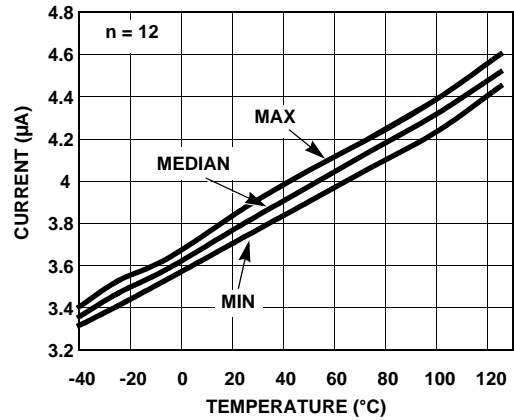

FIGURE 18. SUPPLY CURRENT vs TEMPERATURE $V_S = \pm 2.5V$ DISABLED, $R_L = \text{INF}$

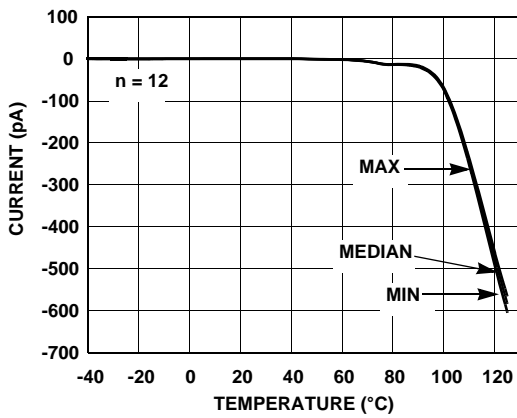

FIGURE 19. I BIAS(+) vs TEMPERATURE $V_S = \pm 2.5V$

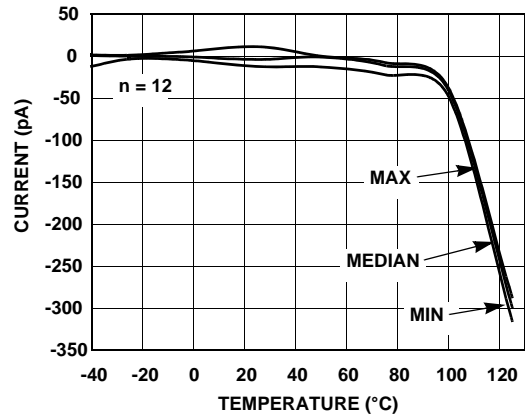

FIGURE 20. I BIAS(-) vs TEMPERATURE $V_S = \pm 2.5V$

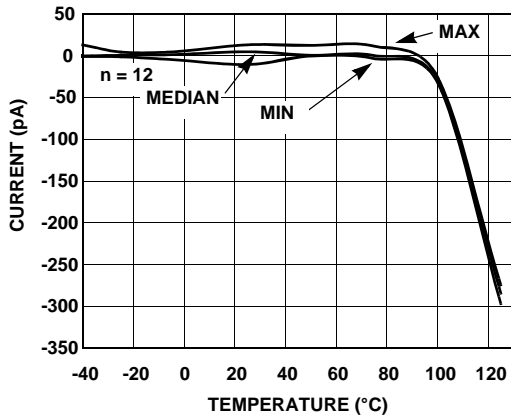

FIGURE 21. INPUT OFFSET CURRENT vs TEMPERATURE $V_S = \pm 2.5V$

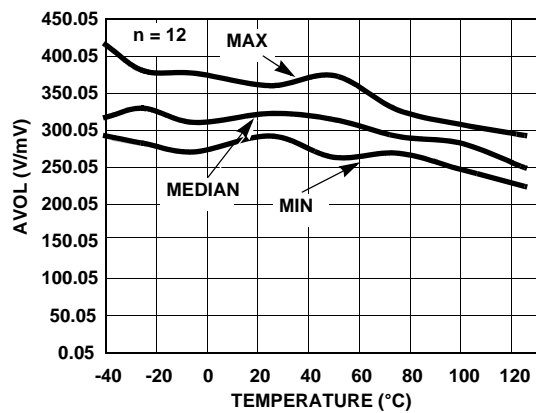

FIGURE 22. AVOL vs TEMPERATURE $R_L = 100k$, $V_O @ +2V/-2V$ @ $V_S \pm 2.5V$

Typical Performance Curves (Continued)

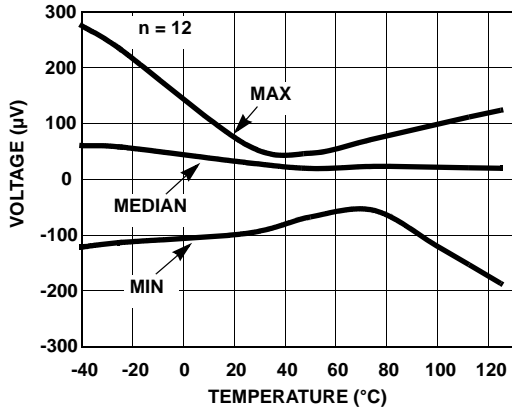

FIGURE 23. INPUT OFFSET VOLTAGE vs TEMPERATURE
 $V_S = \pm 2.5V$

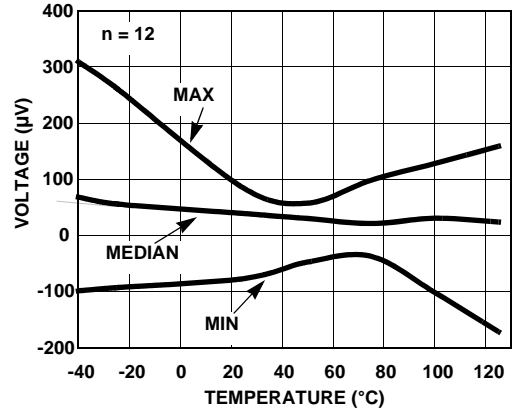

FIGURE 24. INPUT OFFSET VOLTAGE vs TEMPERATURE
 $V_S = \pm 1.2V$

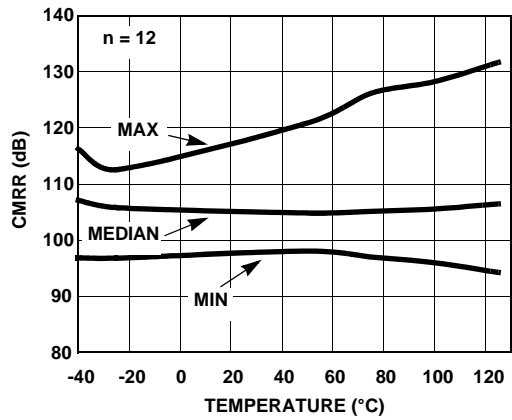

FIGURE 25. CMRR vs TEMPERATURE, FREQ = 0Hz,
 $V_{CM} = +2.5V$ TO $-2.5V$

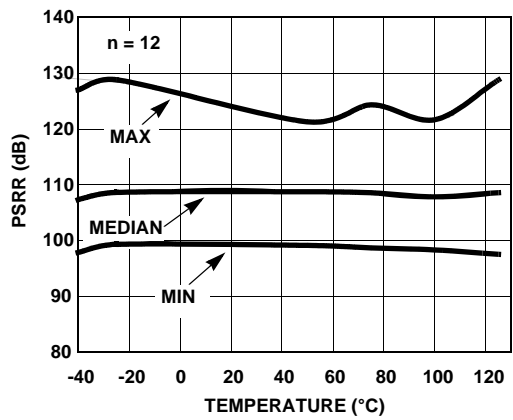

FIGURE 26. PSRR vs TEMPERATURE, FREQ = 0Hz,
 $V_S = \pm 1.2V$ TO $\pm 2.5V$

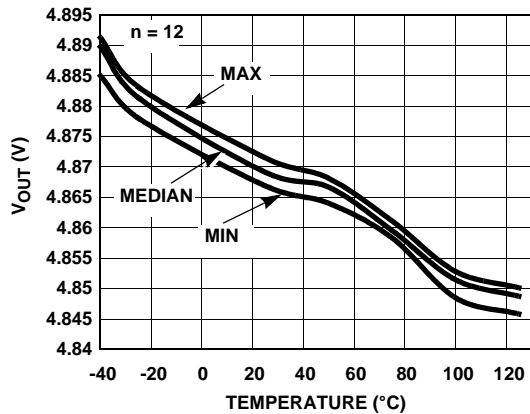

FIGURE 27. POSITIVE V_{OUT} vs TEMPERATURE $R_L = 1k$,
 $V_S = \pm 2.5V$

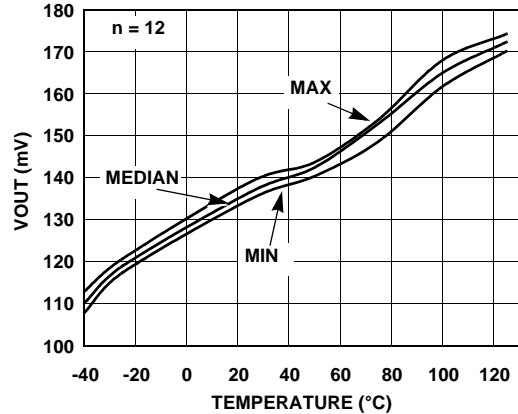

FIGURE 28. NEGATIVE V_{OUT} vs TEMPERATURE $R_L = 1k$,
 $V_S = \pm 2.5V$

Typical Performance Curves (Continued)

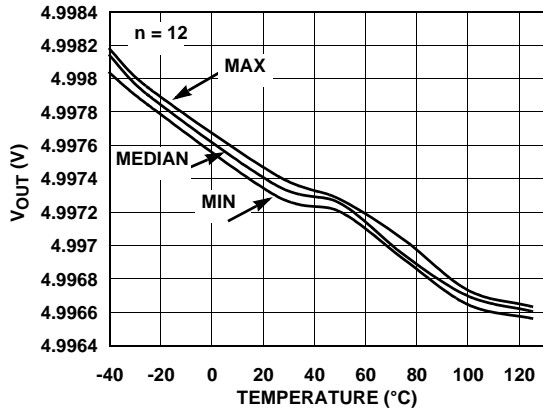

FIGURE 29. POSITIVE V_{OUT} vs TEMPERATURE $R_L = 100k$, $V_S = \pm 2.5V$

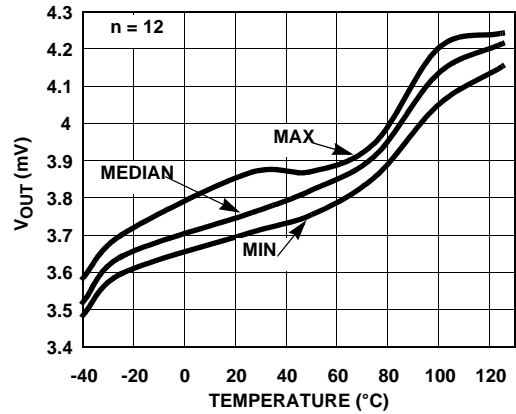

FIGURE 30. NEGATIVE V_{OUT} vs TEMPERATURE $R_L = 100k$, $V_S = \pm 2.5V$

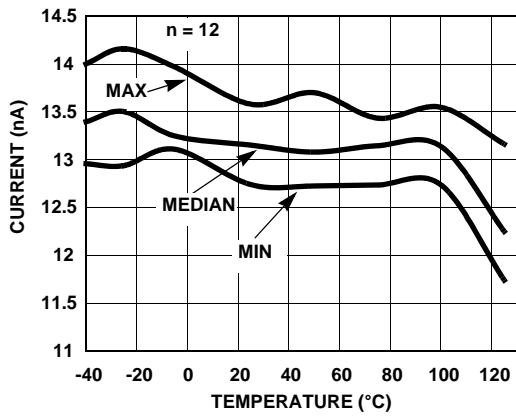

FIGURE 31. I_{IL} (EN) vs TEMPERATURE $V_S = \pm 2.5V$

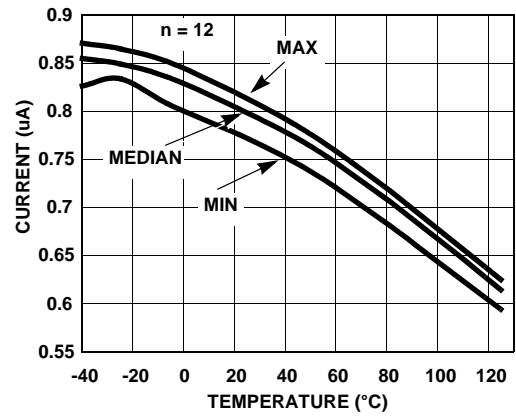

FIGURE 32. I_{iH} (EN) vs TEMPERATURE $V_S = \pm 2.5V$

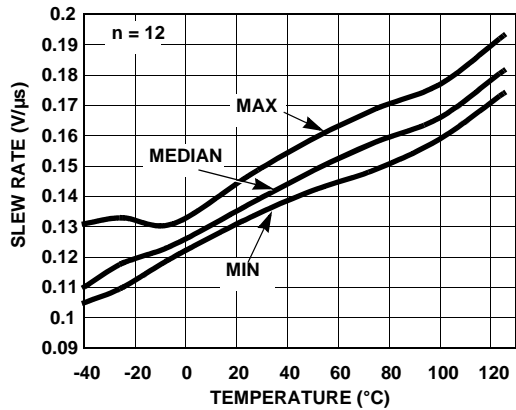

FIGURE 33. +SLEW RATE vs TEMPERATURE $V_S = \pm 2.5V$, INPUT = $\pm 0.75V$ $A_V = 2$

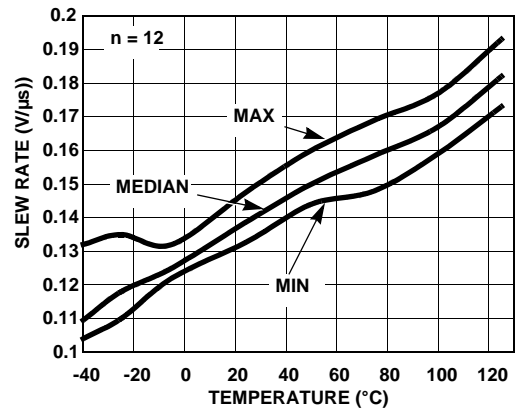

FIGURE 34. -SLEW RATE vs TEMPERATURE $V_S = \pm 2.5V$, INPUT = $\pm 0.75V$ $A_V = 2$

Typical Performance Curves (Continued)

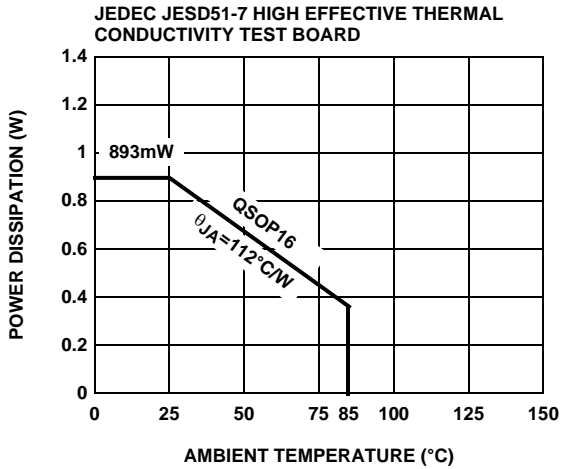

FIGURE 35. PACKAGE POWER DISSIPATION vs AMBIENT TEMPERATURE

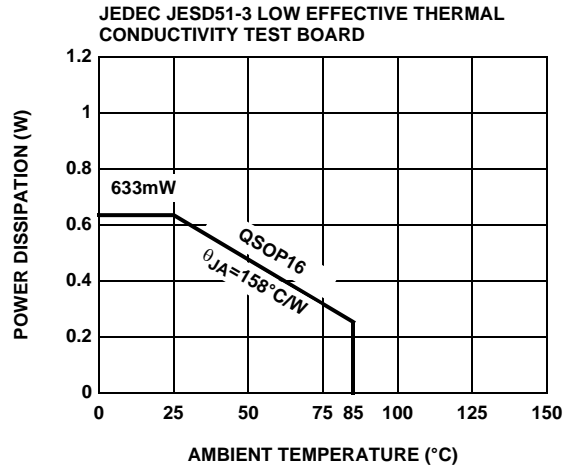
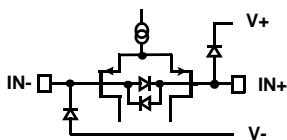

FIGURE 36. PACKAGE POWER DISSIPATION vs AMBIENT TEMPERATURE

Pin Descriptions

ISL28278 (16 LD QSOP)	ISL28478 (16 LD QSOP)	PIN NAME	EQUIVALENT CIRCUIT	DESCRIPTION
3	1	OUT_A	Circuit 3	Amplifier A output
4	2	IN-_A	Circuit 1	Amplifier A inverting input
5	3	IN+_A	Circuit 1	Amplifier A non-inverting input
15	4	V+	Circuit 4	Positive power supply
12	5	IN+_B	Circuit 1	Amplifier B non-inverting input
13	6	IN-_B	Circuit 1	Amplifier B inverting input
14	7	OUT_B	Circuit 3	Amplifier B output
1, 2, 8, 9, 10, 16	8, 9	NC		No internal connection
	10	OUT_C	Circuit 3	Amplifier C output
	11	IN-_C	Circuit 1	Amplifier C inverting input
	12	IN+_C	Circuit 1	Amplifier B non-inverting input
7	13	V-	Circuit 4	Negative power supply
	14	IN+_D	Circuit 1	Amplifier D non-inverting input
	15	IN-_D	Circuit 1	Amplifier D inverting input
	16	OUT_D	Circuit 3	Amplifier D output
6		$\overline{\text{EN}}_A$	Circuit 2	Amplifier A enable pin internal pull-down; Logic "1" selects the disabled state; Logic "0" selects the enabled state.
11		$\overline{\text{EN}}_B$	Circuit 2	Amplifier B enable pin with internal pull-down; Logic "1" selects the disabled state; Logic "0" selects the enabled state.



CIRCUIT 1

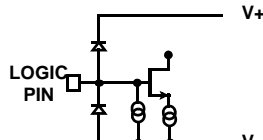

CIRCUIT 2

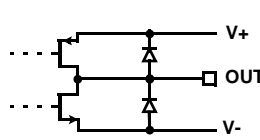

CIRCUIT 3

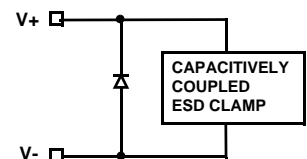

CIRCUIT 4

Applications Information

Introduction

The ISL28278 and ISL28478 are Dual and Quad channel CMOS rail-to-rail input, output (RRIO) micropower precision operational amplifier with an enable feature. The parts are designed to operate from single supply (2.4V to 5.0V) or dual supply ($\pm 1.2V$ to $\pm 2.5V$) while drawing only 120 μA of supply current. The device has an input common mode range that extends 10% above the positive rail and up to 100mV below the negative supply rail. The output operation can swing within about 4mV of the supply rails with a 100k Ω load (reference Figures 27 through 30). This combination of low power and precision performance makes them suitable for solar and battery power applications.

Rail-to-Rail Input

The input common-mode voltage range of the ISL28278 and ISL28478 is from the negative supply to 10% greater than the positive supply without introducing additional offset errors or degrading performance associated with a conventional rail-to-rail input operational amplifier. Many rail-to-rail input stages use two differential input pairs, a long-tail PNP (or PFET) and an NPN (or NFET). Severe penalties have to be paid for this circuit topology. As the input signal moves from one supply rail to another, the operational amplifier switches from one input pair to the other causing drastic changes in input offset voltage and an undesired change in magnitude and polarity of input offset current.

The ISL28278 and ISL28487 achieve input rail-to-rail operation without sacrificing important precision specifications and degrading distortion performance. The devices' input offset voltage exhibits a smooth behavior throughout the entire common-mode input range. The input bias current versus the common-mode voltage range gives us an undistorted behavior from typically 100mV below the negative rail and 10% higher than the V+ rail (0.5V higher than V+ when V+ equals 5V).

Input Protection

All input terminals have internal ESD protection diodes to both positive and negative supply rails, limiting the input voltage to within one diode beyond the supply rails. They have additional back-to-back diodes across the input terminals. For applications where the input differential voltage is expected to exceed 0.5V, external series resistors must be used to ensure the input currents never exceed 5mA.

Rail-to-Rail Output

A pair of complementary MOSFET devices are used to achieve the rail-to-rail output swing. The NMOS sinks current to swing the output in the negative direction. The PMOS sources current to swing the output in the positive direction. The ISL28278 and ISL28478 with a 100k Ω load

will swing to within 4mV of the positive supply rail and within 3mV of the negative supply rail.

Enable/Disable Feature

The ISL28278 has an \overline{EN} pin that disables the device when pulled up to at least 2.0V. In the disabled state (output in a high impedance state), the part consumes typically 4 μA . By disabling the part, multiple ISL28278 parts can be connected together as a MUX. In this configuration, the outputs are tied together in parallel and a channel can be selected by the \overline{EN} pin. The \overline{EN} pin also has an internal pull down. If left open, the \overline{EN} pin will pull to the negative rail and the device will be enabled by default.

The loading effects of the feedback resistors of the disabled amplifier must be considered when multiple amplifier outputs are connected together.

Using Only One Channel

The ISL28278 and ISL28478 are Dual and Quad channel opamps. If the application only requires one channel when using the ISL28278 or less than 4 channels when using the ISL28478, the user must configure the unused channel (s) to prevent them from oscillating. The unused channel (s) will oscillate if the input and output pins are floating. This will result in higher than expected supply currents and possible noise injection into the channel being used. The proper way to prevent this oscillation is to short the output to the negative input and ground the positive input (as shown in Figure 37).

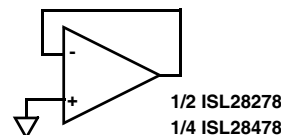

FIGURE 37. PREVENTING OSCILLATIONS IN UNUSED CHANNELS

Proper Layout Maximizes Performance

To achieve the maximum performance of the high input impedance and low offset voltage, care should be taken in the circuit board layout. The PC board surface must remain clean and free of moisture to avoid leakage currents between adjacent traces. Surface coating of the circuit board will reduce surface moisture and provide a humidity barrier, reducing parasitic resistance on the board. When input leakage current is a concern, the use of guard rings around the amplifier inputs will further reduce leakage currents. Figure 38 shows a guard ring example for a unity gain amplifier that uses the low impedance amplifier output at the same voltage as the high impedance input to eliminate surface leakage. The guard ring does not need to be a specific width, but it should form a continuous loop around both inputs. For further reduction of leakage currents,

components can be mounted to the PC board using Teflon standoff insulators.

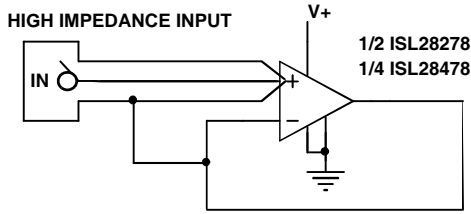

FIGURE 38. GUARD RING EXAMPLE FOR UNITY GAIN AMPLIFIER

Example Application

Thermocouples are the most popular temperature-sensing device because of their low cost, interchangeability, and ability to measure a wide range of temperatures. The ISL28278 (Figure 39) is used to convert the differential thermocouple voltage into single-ended signal with 10X gain. The ISL28278's rail-to-rail input characteristic allows the thermocouple to be biased at ground and the amplifier to run from a single 5V supply.

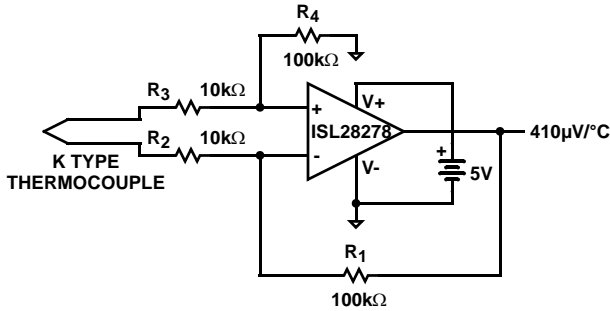

FIGURE 39. THERMOCOUPLE AMPLIFIER

Current Limiting

The ISL28278 and ISL28478 have no internal current-limiting circuitry. If the output is shorted, it is possible to exceed the Absolute Maximum Rating for output current or power dissipation, potentially resulting in the destruction of the device.

Power Dissipation

It is possible to exceed the +150°C maximum junction temperatures under certain load and power-supply conditions. It is therefore important to calculate the maximum junction temperature (T_{JMAX}) for all applications to determine if power supply voltages, load conditions, or package type need to be modified to remain in the safe operating area. These parameters are related in Eq.1.:

$$T_{JMAX} = T_{MAX} + (\theta_{JA} \times PD_{MAXTOTAL}) \quad (EQ. 1)$$

where:

- $PD_{MAXTOTAL}$ is the sum of the maximum power dissipation of each amplifier in the package (PD_{MAX})
- PD_{MAX} for each amplifier can be calculated as shown in Eq.2:

$$PD_{MAX} = 2 \times V_S \times I_{SMAX} + (V_S - V_{OUTMAX}) \times \frac{V_{OUTMAX}}{R_L} \quad (EQ. 2)$$

where:

- T_{MAX} = Maximum ambient temperature
- θ_{JA} = Thermal resistance of the package
- PD_{MAX} = Maximum power dissipation of 1 amplifier
- V_S = Supply voltage
- I_{MAX} = Maximum supply current of 1 amplifier
- V_{OUTMAX} = Maximum output voltage swing of the application
- R_L = Load resistance

Quarter Size Outline Plastic Packages Family (QSOP)

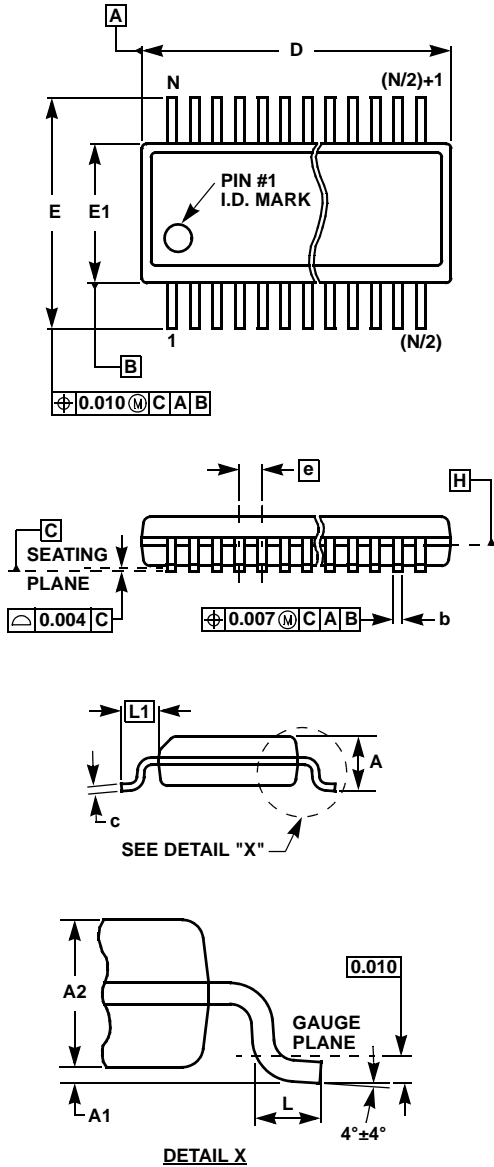

MDP0040

QUARTER SIZE OUTLINE PLASTIC PACKAGES FAMILY

SYMBOL	QSOP16	QSOP24	QSOP28	TOLERANCE	NOTES
A	0.068	0.068	0.068	Max.	-
A1	0.006	0.006	0.006	±0.002	-
A2	0.056	0.056	0.056	±0.004	-
b	0.010	0.010	0.010	±0.002	-
c	0.008	0.008	0.008	±0.001	-
D	0.193	0.341	0.390	±0.004	1, 3
E	0.236	0.236	0.236	±0.008	-
E1	0.154	0.154	0.154	±0.004	2, 3
e	0.025	0.025	0.025	Basic	-
L	0.025	0.025	0.025	±0.009	-
L1	0.041	0.041	0.041	Basic	-
N	16	24	28	Reference	-

Rev. E 3/01

NOTES:

1. Plastic or metal protrusions of 0.006" maximum per side are not included.
2. Plastic interlead protrusions of 0.010" maximum per side are not included.
3. Dimensions "D" and "E1" are measured at Datum Plane "H".
4. Dimensioning and tolerancing per ASME Y14.5M-1994.

All Intersil U.S. products are manufactured, assembled and tested utilizing ISO9000 quality systems. Intersil Corporation's quality certifications can be viewed at www.intersil.com/design/quality

Intersil products are sold by description only. Intersil Corporation reserves the right to make changes in circuit design, software and/or specifications at any time without notice. Accordingly, the reader is cautioned to verify that data sheets are current before placing orders. Information furnished by Intersil is believed to be accurate and reliable. However, no responsibility is assumed by Intersil or its subsidiaries for its use; nor for any infringements of patents or other rights of third parties which may result from its use. No license is granted by implication or otherwise under any patent or patent rights of Intersil or its subsidiaries.

For information regarding Intersil Corporation and its products, see www.intersil.com