

# Anti-surge Chip Resistors

## ESR Series

### ●Features

- 1) Exclusive resistive element pattern and laser trimming technology results in significantly improved surge resistance characteristics.
- 2) 2kV to 5kV electrostatic discharge resistance.
- 3) Superior power ratings.
- 4) ROHM resistors have obtained ISO9001 / ISO / TS16949 certification.
- 5) Corresponds to AEC-Q200.(ESR10/18)

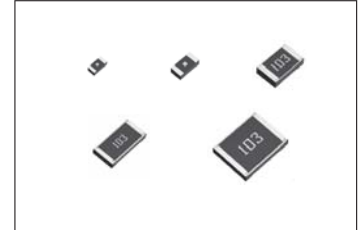

### ●Products List

| Part No. | Size |        | Rated Power (70°C)<br>(W) | Limiting Element Voltage<br>(V) | Maximum Overload Voltage<br>(V) | Temperature Coefficient<br>(ppm / °C) | Resistance Tolerance<br>(%) | Resistance Range | Series | Operating Temperature Range<br>(°C) |
|----------|------|--------|---------------------------|---------------------------------|---------------------------------|---------------------------------------|-----------------------------|------------------|--------|-------------------------------------|
|          | (mm) | (inch) |                           |                                 |                                 |                                       |                             |                  |        |                                     |
| ESR01    | 1005 | 0402   | 0.2                       | 50                              | 100                             | ±200                                  | J(±5%)                      | 10Ω to 1MΩ       | E24    | -55 to +155                         |
|          |      |        |                           |                                 |                                 | ±100                                  | F(±1%)                      |                  |        |                                     |
| ESR03    | 1608 | 0603   | 0.25                      | 150                             | 200                             | ±200                                  | J(±5%)                      | 1Ω to 10MΩ       | E24    | -55 to +155                         |
|          |      |        |                           |                                 |                                 | ±100                                  | F(±1%)                      | 10Ω to 1MΩ       |        |                                     |
|          |      |        |                           |                                 |                                 | ±100                                  | D(±0.5%)                    | 10Ω to 1MΩ       |        |                                     |
| ESR10    | 2012 | 0805   | 0.4                       | 150                             | 200                             | ±200                                  | J(±5%)                      | 1Ω to 10MΩ       | E24    | -55 to +155                         |
|          |      |        |                           |                                 |                                 | ±100                                  | F(±1%)                      | 10Ω to 1MΩ       |        |                                     |
| ESR18    | 3216 | 1206   | 0.33                      | 200                             | 400                             | ±200                                  | J(±5%)                      | 1Ω to 10MΩ       | E24    | -55 to +155                         |
|          |      |        |                           |                                 |                                 | ±100                                  | F(±1%)                      | 10Ω to 1MΩ       |        |                                     |
|          |      |        |                           |                                 |                                 | ±100                                  | D(±0.5%)                    | 10Ω to 1MΩ       |        |                                     |
| ESR25    | 3225 | 1210   | 0.5                       | 200                             | 400                             | ±200                                  | J(±5%)                      | 1Ω to 10MΩ       | E24    | -55 to +155                         |
|          |      |        |                           |                                 |                                 | ±100                                  | F(±1%)                      | 10Ω to 1MΩ       |        |                                     |
|          |      |        |                           |                                 |                                 | ±100                                  | D(±0.5%)                    | 10Ω to 1MΩ       |        |                                     |

\*Design and specifications are subject to change without notice.  
Carefully check the specification sheet supplied with the product before using or ordering it.

### ●Part Number Description

| <b>E S R</b>   | <b>1 0</b>  | <b>E Z P</b>   | <b>J</b>        | <b>1 0 0</b> |                          |                 |       |     |                        |        |       |     |                        |       |       |     |                        |       |       |     |                        |       |       |     |                           |       |  |  |                      |                 |      |            |   |            |
|--|---|--|-----------------|--------------|--------------------------|-----------------|-------|-----|------------------------|--------|-------|-----|------------------------|-------|-------|-----|------------------------|-------|-------|-----|------------------------|-------|-------|-----|---------------------------|-------|--|--|----------------------|-----------------|------|------------|---|------------|
| <b>Part No.</b><br><b>ESR</b><br>(Anti-surge chip resistors) | <b>Size (mm [inch])</b><br>01 (1005 [0402])<br>03 (1608 [0603])<br>10 (2012 [0805])<br>18 (3216 [1206])<br>25 (3225 [1210]) | <b>Packaging Specifications Code</b> <table border="1" style="width: 100%; border-collapse: collapse;"> <thead> <tr> <th>Part No.</th> <th>Code</th> <th>Packaging specifications</th> <th>Quantity / Reel</th> </tr> </thead> <tbody> <tr> <td>ESR01</td> <td>MZP</td> <td>Paper tape (4mm Pitch)</td> <td>10,000</td> </tr> <tr> <td>ESR03</td> <td>EZP</td> <td>Paper tape (4mm Pitch)</td> <td>5,000</td> </tr> <tr> <td>ESR10</td> <td>EZP</td> <td>Paper tape (4mm Pitch)</td> <td>5,000</td> </tr> <tr> <td>ESR18</td> <td>EZP</td> <td>Paper tape (4mm Pitch)</td> <td>5,000</td> </tr> <tr> <td>ESR25</td> <td>JZP</td> <td>Embossed tape (4mm Pitch)</td> <td>4,000</td> </tr> </tbody> </table> | Part No.        | Code         | Packaging specifications | Quantity / Reel | ESR01 | MZP | Paper tape (4mm Pitch) | 10,000 | ESR03 | EZP | Paper tape (4mm Pitch) | 5,000 | ESR10 | EZP | Paper tape (4mm Pitch) | 5,000 | ESR18 | EZP | Paper tape (4mm Pitch) | 5,000 | ESR25 | JZP | Embossed tape (4mm Pitch) | 4,000 | <b>Resistance Tolerance</b><br>D ( ±0.5% )<br>F ( ±1% )<br>J ( ±5% ) | <b>Nominal Resistance</b><br>Resistance code, 3 or 4 digits.<br>000 denotes jumper type. <table border="1" style="width: 100%; border-collapse: collapse; margin-top: 5px;"> <thead> <tr> <th>Resistance tolerance</th> <th>Resistance code</th> </tr> </thead> <tbody> <tr> <td>D, F</td> <td>: 4 digits</td> </tr> <tr> <td>J</td> <td>: 3 digits</td> </tr> </tbody> </table> <p>Ex.)</p> <p>1Ω = 1R00 ( ±1% )<br/>                     1R0 ( ±5% )<br/>                     10Ω = 10R0 ( ±0.5%, ±1% )<br/>                     100 ( ±5% )<br/>                     1MΩ = 1004 ( ±0.5%, ±1% )<br/>                     105 ( ±5% )</p> | Resistance tolerance | Resistance code | D, F | : 4 digits | J | : 3 digits |
| Part No.   | Code  | Packaging specifications   | Quantity / Reel |              |                          |                 |       |     |                        |        |       |     |                        |       |       |     |                        |       |       |     |                        |       |       |     |                           |       |  |  |                      |                 |      |            |   |            |
| ESR01  | MZP   | Paper tape (4mm Pitch)   | 10,000          |              |                          |                 |       |     |                        |        |       |     |                        |       |       |     |                        |       |       |     |                        |       |       |     |                           |       |  |  |                      |                 |      |            |   |            |
| ESR03  | EZP   | Paper tape (4mm Pitch)   | 5,000           |              |                          |                 |       |     |                        |        |       |     |                        |       |       |     |                        |       |       |     |                        |       |       |     |                           |       |  |  |                      |                 |      |            |   |            |
| ESR10  | EZP   | Paper tape (4mm Pitch)   | 5,000           |              |                          |                 |       |     |                        |        |       |     |                        |       |       |     |                        |       |       |     |                        |       |       |     |                           |       |  |  |                      |                 |      |            |   |            |
| ESR18  | EZP   | Paper tape (4mm Pitch)   | 5,000           |              |                          |                 |       |     |                        |        |       |     |                        |       |       |     |                        |       |       |     |                        |       |       |     |                           |       |  |  |                      |                 |      |            |   |            |
| ESR25  | JZP   | Embossed tape (4mm Pitch)  | 4,000           |              |                          |                 |       |     |                        |        |       |     |                        |       |       |     |                        |       |       |     |                        |       |       |     |                           |       |  |  |                      |                 |      |            |   |            |
| Resistance tolerance   | Resistance code   |  |                 |              |                          |                 |       |     |                        |        |       |     |                        |       |       |     |                        |       |       |     |                        |       |       |     |                           |       |  |  |                      |                 |      |            |   |            |
| D, F   | : 4 digits  |  |                 |              |                          |                 |       |     |                        |        |       |     |                        |       |       |     |                        |       |       |     |                        |       |       |     |                           |       |  |  |                      |                 |      |            |   |            |
| J  | : 3 digits  |  |                 |              |                          |                 |       |     |                        |        |       |     |                        |       |       |     |                        |       |       |     |                        |       |       |     |                           |       |  |  |                      |                 |      |            |   |            |

●Chip Resistor Dimensions and Markings

■ ESR01 / 03

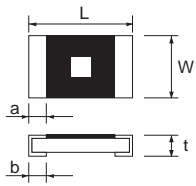

■ ESR10 / 18 / 25

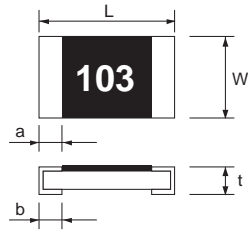

<Marking method>

There are three or four digits used for the calculation number according to IEC code and "R" is used for the decimal point.

(Unit : mm)

| Part No. | (mm) | (inch) | L        | W        | t         | a        | b                                     | Marking existence |
|----------|------|--------|----------|----------|-----------|----------|---------------------------------------|-------------------|
| ESR01    | 1005 | 0402   | 1.0±0.05 | 0.5±0.05 | 0.35±0.05 | 0.2±0.1  | 0.25 <sup>+0.05</sup> <sub>-0.1</sub> | No *              |
| ESR03    | 1608 | 0603   | 1.6±0.1  | 0.8±0.1  | 0.45±0.1  | 0.3±0.2  | 0.3±0.2                               | No *              |
| ESR10    | 2012 | 0805   | 2.0±0.1  | 1.25±0.1 | 0.55±0.1  | 0.3±0.2  | 0.4±0.2                               | Yes               |
| ESR18    | 3216 | 1206   | 3.2±0.15 | 1.6±0.15 | 0.55±0.1  | 0.3±0.25 | 0.5±0.25                              | Yes               |
| ESR25    | 3225 | 1210   | 3.2±0.15 | 2.5±0.15 | 0.55±0.1  | 0.3±0.25 | 0.5±0.25                              | Yes               |

\*Only with square mark

●Land pattern Example

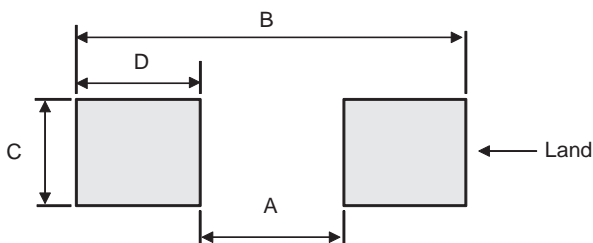

(Unit : mm)

| Part No. | A   | B   | C    | D   |
|----------|-----|-----|------|-----|
| ESR01    | 0.5 | 1.3 | 0.5  | 0.4 |
| ESR03    | 1.0 | 2.0 | 0.8  | 0.5 |
| ESR10    | 1.2 | 2.6 | 1.15 | 0.7 |
| ESR18    | 2.2 | 4.0 | 1.5  | 0.9 |
| ESR25    | 2.2 | 4.0 | 2.3  | 0.9 |

### ●Derating Curve

When the ambient temperature exceeds 70°C, power dissipation must be adjusted according to the derating curves below.

■ ESR01 / 03 / 10 / 18 / 25

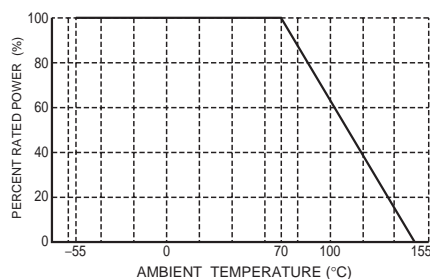

### ●Characteristics

| Test Items                               | Guaranteed Value   | Test Conditions   |
|--|--|---|
|  | Resistor Type  |   |
| Resistance                               | See P.1  | 20°C  |
| Variation of resistance with temperature | See P.1  | Measurement : +20 / -55 / +20 / +125°C  |
| Overload                                 | $\pm (2.0\%+0.1\Omega)$  | Rated voltage (current) $\times 2.0$ , 2s (ESR01)<br>Rated voltage (current) $\times 2.5$ , 2s (ESR03 / 10 / 18 / 25)<br>Maximum overload voltage           |
| Solderability                            | A new uniform coating of minimum of 95% of the surface being immersed and no soldering damage. | Rosin-Ethanol : 25% (Weight)<br>Soldering condition : $235\pm 5^\circ\text{C}$<br>Duration of immersion : $2.0\pm 0.5\text{s}$                              |
| Resistance to soldering heat             | $\pm (1.0\%+0.05\Omega)$<br>No remarkable abnormality on the appearance.                       | Soldering condition : $260\pm 5^\circ\text{C}$<br>Duration of immersion : $10\pm 1\text{s}$   |
| Rapid change of temperature              | $\pm (1.0\%+0.05\Omega)$   | Test temp. : $-55^\circ\text{C}$ to $+125^\circ\text{C}$ 5cycle   |
| Damp heat, steady state                  | $\pm (3.0\%+0.1\Omega)$  | $40^\circ\text{C}$ , 93%RH (Relative Humidity)<br>Test time : 1,000h to 1,048h  |
| Endurance at 70°C                        | $\pm (3.0\%+0.1\Omega)$  | $70^\circ\text{C}$<br>Rated voltage (current)<br>1.5h : ON – 0.5h : OFF<br>Test time : 1,000h to 1,048h   |
| Endurance                                | $\pm (3.0\%+0.1\Omega)$  | $155^\circ\text{C}$<br>Test time : 1,000h to 1,048h   |
| Resistance to solvent                    | $\pm (1.0\%+0.05\Omega)$   | $23\pm 5^\circ\text{C}$ , Immersion cleaning, $5\pm 0.5\text{min}$<br>Solvent : 2-propanol  |
| Bend strength of the end face plating    | $\pm (1.0\%+0.05\Omega)$<br>Without mechanical damage such as breaks.                          | —   |
| Static electric characteristics          | $\pm (5.0\%+0.05\Omega)$   | EIAJ ED-4701 / 300 TEST METHOD304<br>Voltage : 2kV (ESR01)<br>3kV (ESR03 / 10 / 18)<br>5kV (ESR25)<br>C : 100pF<br>R : 1.5k $\Omega$<br>Apply cycle : 1time |

Compliance Standard(s) : IEC60115-8  
JISC 5201-8

### ●Chip weight (typical value)

| Parameter | Unit  | ESR01 | ESR03 | ESR10 | ESR18 | ESR25 |
|-----------|-------|-------|-------|-------|-------|-------|
| Weight    | mg/pc | 0.63  | 2.18  | 5.13  | 9.62  | 16.47 |

●Tape Dimensions

■ Paper Tape

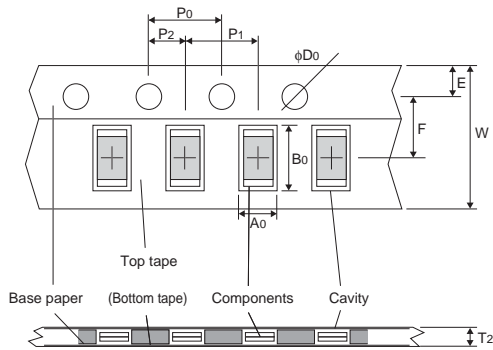

(Unit : mm)

| Part No. | W       | F        | E        | A <sub>0</sub>                        | B <sub>0</sub>                        |
|----------|---------|----------|----------|---------------------------------------|---------------------------------------|
| ESR01    | 8.0±0.3 | 3.5±0.05 | 1.75±0.1 | 0.7±0.1                               | 1.2±0.1                               |
| ESR03    | 8.0±0.3 | 3.5±0.05 | 1.75±0.1 | 1.1±0.1                               | 1.9±0.1                               |
| ESR10    | 8.0±0.3 | 3.5±0.05 | 1.75±0.1 | 1.65 <sup>+0.2</sup> <sub>-0.1</sub>  | 2.4 <sup>+0.2</sup> <sub>-0.1</sub>   |
| ESR18    | 8.0±0.3 | 3.5±0.05 | 1.75±0.1 | 1.95 <sup>+0.1</sup> <sub>-0.05</sub> | 3.5 <sup>+0.15</sup> <sub>-0.05</sub> |

| Part No. | D <sub>0</sub>                    | P <sub>0</sub> | P <sub>1</sub> | P <sub>2</sub> | T <sub>2</sub> |
|----------|-----------------------------------|----------------|----------------|----------------|----------------|
| ESR01    | φ1.5 <sup>+0.1</sup> <sub>0</sub> | 4.0±0.1        | 2.0±0.05       | 2.0±0.05       | Max 1.1        |
| ESR03    | φ1.5 <sup>+0.1</sup> <sub>0</sub> | 4.0±0.1        | 4.0±0.1        | 2.0±0.05       | Max 1.1        |
| ESR10    | φ1.5 <sup>+0.1</sup> <sub>0</sub> | 4.0±0.1        | 4.0±0.1        | 2.0±0.05       | Max 1.1        |
| ESR18    | φ1.5 <sup>+0.1</sup> <sub>0</sub> | 4.0±0.1        | 4.0±0.1        | 2.0±0.05       | Max 1.1        |

■ Embossed Tape

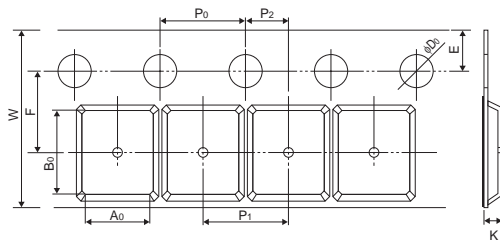

(Unit : mm)

| Part No. | W                                 | F              | E              | A <sub>0</sub> | B <sub>0</sub> |
|----------|-----------------------------------|----------------|----------------|----------------|----------------|
| ESR25    | 8.0±0.3                           | 3.5±0.05       | 1.75±0.1       | 3.0±0.1        | 3.5±0.1        |
|          | D <sub>0</sub>                    | P <sub>0</sub> | P <sub>1</sub> | P <sub>2</sub> | K              |
|          | φ1.5 <sup>+0.1</sup> <sub>0</sub> | 4.0±0.1        | 4.0±0.1        | 2.0±0.05       | Max 1.1        |

●Reel Dimensions

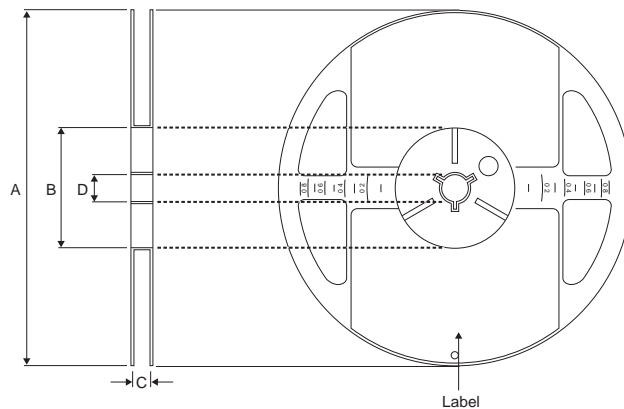

ACCORDING TO EIAJ ET-7200B

(Unit : mm)

| Part No. | A                                 | B                                | C                              | D       |
|----------|-----------------------------------|----------------------------------|--------------------------------|---------|
| ESR01    | φ180 <sup>0</sup> <sub>-1.5</sub> | φ60 <sup>+1.0</sup> <sub>0</sub> | 9 <sup>+1.0</sup> <sub>0</sub> | φ13±0.2 |
| ESR03    |                                   |                                  |                                |         |
| ESR10    |                                   |                                  |                                |         |
| ESR18    |                                   |                                  |                                |         |
| ESR25    |                                   |                                  |                                |         |

## Notes

No copying or reproduction of this document, in part or in whole, is permitted without the consent of ROHM Co.,Ltd.

The content specified herein is subject to change for improvement without notice.

The content specified herein is for the purpose of introducing ROHM's products (hereinafter "Products"). If you wish to use any such Product, please be sure to refer to the specifications, which can be obtained from ROHM upon request.

Examples of application circuits, circuit constants and any other information contained herein illustrate the standard usage and operations of the Products. The peripheral conditions must be taken into account when designing circuits for mass production.

Great care was taken in ensuring the accuracy of the information specified in this document. However, should you incur any damage arising from any inaccuracy or misprint of such information, ROHM shall bear no responsibility for such damage.

The technical information specified herein is intended only to show the typical functions of and examples of application circuits for the Products. ROHM does not grant you, explicitly or implicitly, any license to use or exercise intellectual property or other rights held by ROHM and other parties. ROHM shall bear no responsibility whatsoever for any dispute arising from the use of such technical information.

The Products specified in this document are intended to be used with general-use electronic equipment or devices (such as audio visual equipment, office-automation equipment, communication devices, electronic appliances and amusement devices).

The Products specified in this document are not designed to be radiation tolerant.

While ROHM always makes efforts to enhance the quality and reliability of its Products, a Product may fail or malfunction for a variety of reasons.

Please be sure to implement in your equipment using the Products safety measures to guard against the possibility of physical injury, fire or any other damage caused in the event of the failure of any Product, such as derating, redundancy, fire control and fail-safe designs. ROHM shall bear no responsibility whatsoever for your use of any Product outside of the prescribed scope or not in accordance with the instruction manual.

The Products are not designed or manufactured to be used with any equipment, device or system which requires an extremely high level of reliability the failure or malfunction of which may result in a direct threat to human life or create a risk of human injury (such as a medical instrument, transportation equipment, aerospace machinery, nuclear-reactor controller, fuel-controller or other safety device). ROHM shall bear no responsibility in any way for use of any of the Products for the above special purposes. If a Product is intended to be used for any such special purpose, please contact a ROHM sales representative before purchasing.

If you intend to export or ship overseas any Product or technology specified herein that may be controlled under the Foreign Exchange and the Foreign Trade Law, you will be required to obtain a license or permit under the Law.



Thank you for your accessing to ROHM product informations.  
More detail product informations and catalogs are available, please contact us.

### ROHM Customer Support System

<http://www.rohm.com/contact/>