

Distinctive Characteristics

Square, round, rectangular, and round panel seal models available.

Stainless steel clips provide secure mounting with a wide range of panel thicknesses.

Latchdown feature gives indication of circuit status. Audible and tactile feedback with smooth and responsive operation.

Snap-action contact mechanism gives long electrical life and sensitivity of actuation.

Combination solder lug and .110" quick connect terminals are epoxy sealed to prevent entry of flux, dust, and other contaminants.

Panel sealed model meets IP65 of IEC60529 specifications (similar to NEMA 4 & 13).

Compact switch design minimizes behind panel depth.

Matching illuminated models available and shown in the Illuminated Pushbutton section.

Matching indicators available and shown at the end of Section M.

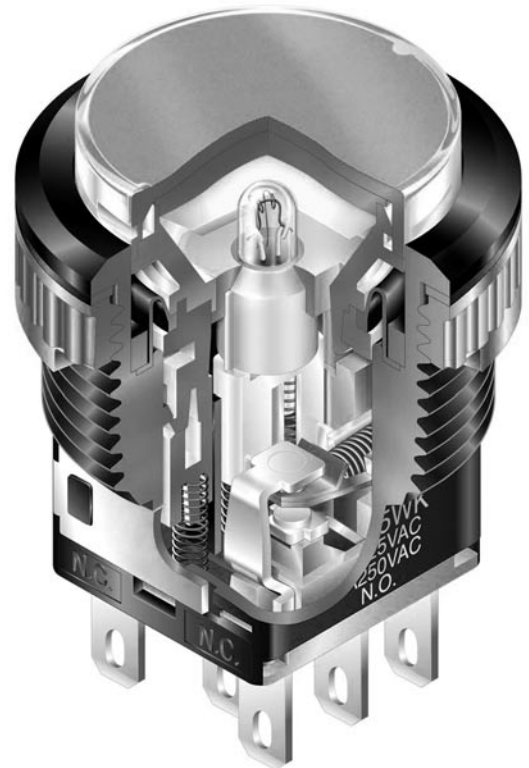

Actual Size

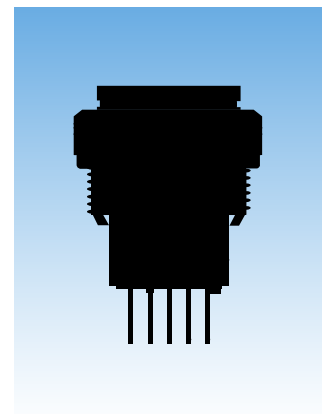

General Specifications

Electrical Capacity (Resistive Load)

- Power Level (silver):** 3A @ 125V AC or 3A @ 250V AC
 - Logic Level (gold):** 0.4VA maximum @ 28V AC/DC maximum
(Applicable Range 0.1mA ~ 0.1A @ 20mV ~ 28V)
- Note: Find additional explanation of operating range in Supplement section.

Other Ratings

- Contact Resistance:** 50 milliohms maximum for silver; 100 milliohms maximum for gold
- Insulation Resistance:** 200 megohms minimum @ 500V DC
- Dielectric Strength:** 1,000V AC minimum between contacts for 1 minute minimum;
1,500V AC minimum between contacts & case for 1 minute minimum
- Mechanical Life:** 1,000,000 operations minimum for momentary circuit
200,000 operations minimum for maintained circuit
- Electrical Life:** 100,000 operations minimum
- Nominal Operating Force:** 5.39N
- Contact Timing:** Nonshorting (break-before-make)
- Travel:** Momentary: Pretravel .059" (1.5mm); Overtravel .059" (1.5mm); Total Travel .118" (3.0mm)
Maintained: Pretravel .087" (2.2mm); Overtravel .031" (0.8mm); Total Travel .118" (3.0mm)

Materials & Finishes

- Housing:** Glass fiber reinforced polyamide (UL94V-0)
- O-ring:** Nitrile butadiene rubber
- Inner Seal:** Silicone rubber
- Movable Contact:** Silver alloy or copper with gold plating
- Stationary Contacts:** Silver alloy or copper with gold plating
- Base:** Liquid crystal polymer (UL94V-0)
- Terminals:** Phosphor bronze with silver or gold plating

Environmental Data

- Operating Temp Range:** -25°C through +70°C (-13°F through +158°F)
Note: When used with a polyvinyl chloride splash cover, the lowest limit is 0°C (32°F)
- Humidity:** 90 ~ 95% humidity for 96 hours @ 40°C (104°F)
- Vibration:** 10 ~ 55Hz with peak-to-peak amplitude of 1.5mm traversing the frequency range & returning in 1 minute; 3 right angled directions for 2 hours
- Shock:** 50G (490m/s²) acceleration (tested in 6 right angled directions, with 5 shocks in each direction)
- Sealing:** IP65 of IEC60529 standard (similar to NEMA 4 & 13)

Installation

- Mounting Torque:** 1.96Nm (17.35 lb·in) maximum
- Cap Installation Force:** 3.92N maximum downward force on cap
- Quick Connect Force:** 52.95N maximum downward force on connector
- Soldering Time & Temperature:** Manual Soldering: See Profile A in Supplement section.

Standards & Certifications

- Flammability Standards:** UL94V-0 housing & base
- UL & C-UL Recognized:** All models recognized at 3A @ 125V or 250V AC or 0.4VA @ 28V AC/DC maximum;
UL File No. WOYR2.E44145; add "/U" to end of part number to order UL mark on switch;
C-UL File No. WOYR8.E44145; add "/C-UL" to end of part number to order C-UL mark on switch.
- CSA Certified:** All models certified at 3A @ 125V or 250V AC or 0.4VA @ 28V AC/DC maximum;
CSA File Nos. 023535-0-000; add "/C" to end of part number to order CSA mark on switch.



TYPICAL SWITCH ORDERING EXAMPLE

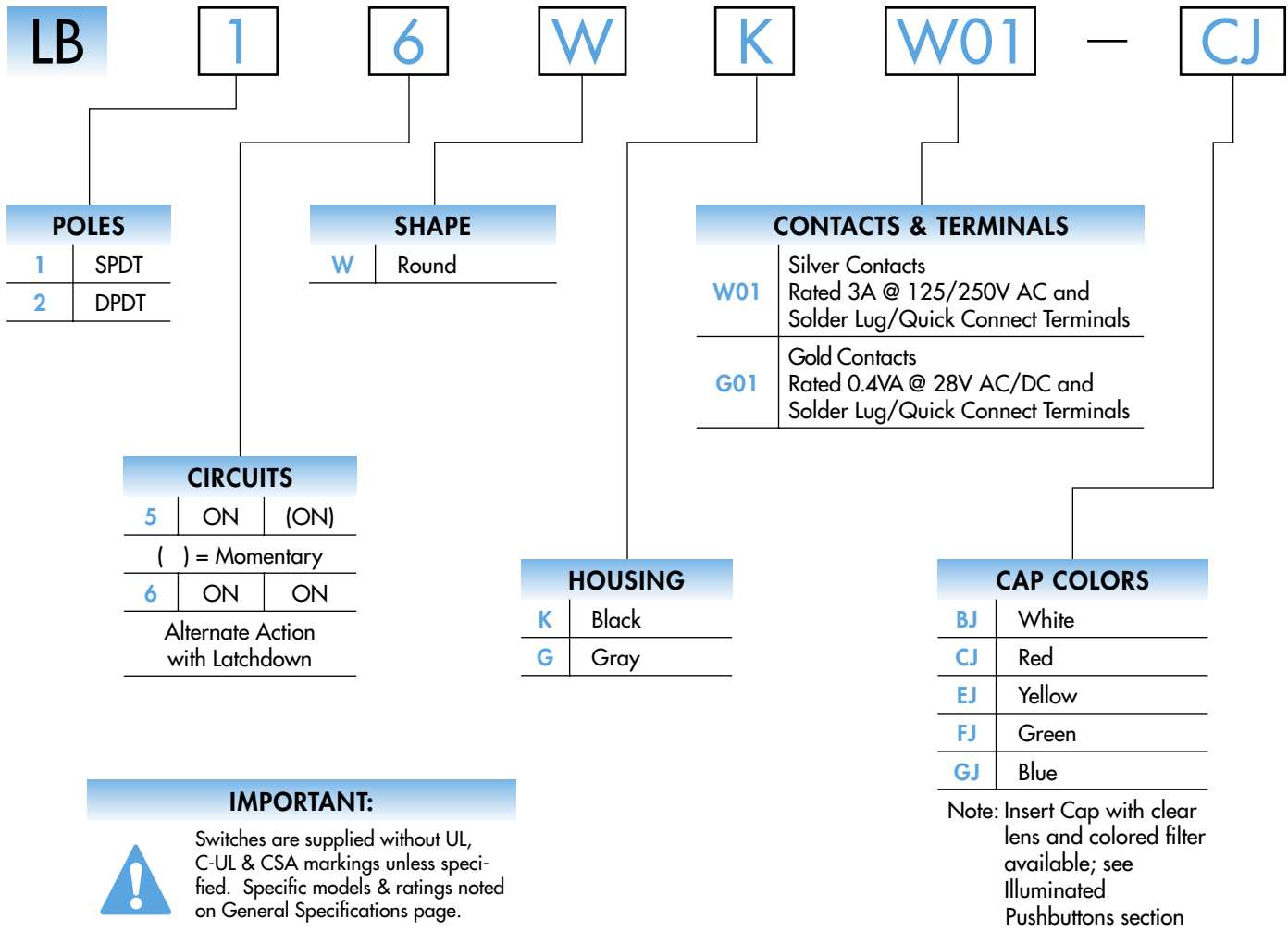

DESCRIPTION FOR TYPICAL ORDERING EXAMPLE

LB16WKW01-CJ

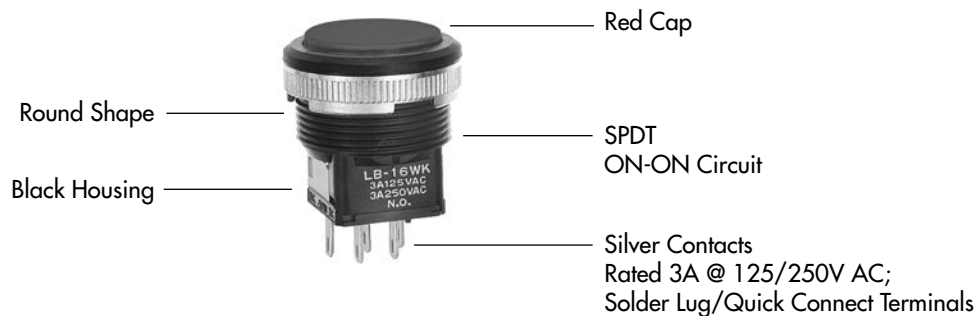

POLES & CIRCUITS

Pole	Model	Plunger Position () = Momentary		Connected Terminals		Throw & Switch/Lamp Schematics
		Normal	Down	Normal	Down	
SP	LB15 *LB16	ON ON	(ON) ON	1-3	1-2	SPDT
DP	LB25 *LB26	ON ON	(ON) ON	1-3 4-6	1-2 4-5	DPDT

* When in latchdown position for the alternate circuit, cap position is .039" (1.0mm) above the built-in bezel.

SHAPE & PANEL CUTOUT

W .866" (22.0mm)
Round

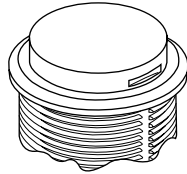

Recommended Panel Thickness:
.039" ~ .157" (1 ~ 4mm)
Recommended Panel Thickness
with Splash Cover:
.039" ~ .138" (1 ~ 3.5mm)
Overtightening the mounting nut AT074
may damage the switch housing.

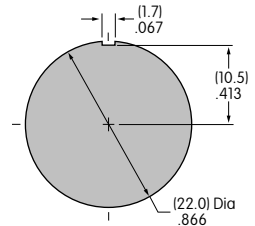

HOUSING

Housing Colors Available:

K Black

G Gray

CONTACT MATERIALS, RATINGS & TERMINALS

W01 Silver Contacts

Power Level
3A @ 125V AC & 250V AC

Solder Lug/Quick Connect

G01 Gold Contacts

Logic Level
0.4VA max. @ 28V AC/DC max.

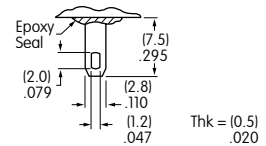

Complete explanation of operating range in Supplement section.

CAP COLORS

Lens/Filter
Colors Available:

BJ White

EJ Yellow

GJ Blue

AT4054

CJ Red

FJ Green

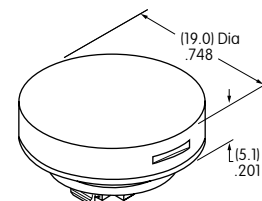

Material: Polycarbonate Finish: Glossy

TYPICAL SWITCH DIMENSIONS

Panel Seal

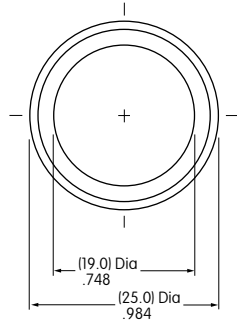

Single & Double Pole

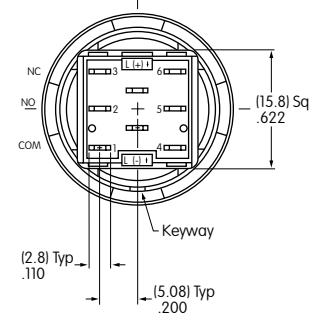
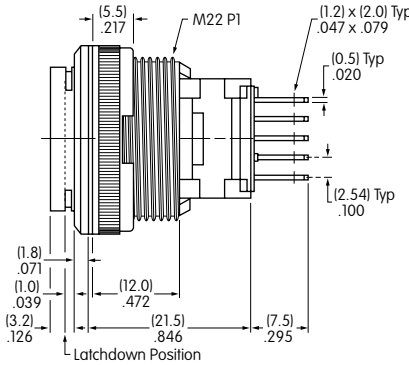

LB25WKW01-CJ

Single pole models do not have terminals 4, 5, & 6.

OPTIONAL ACCESSORIES

PCB Adaptors

AT711 Single Pole • Straight PC Terminals

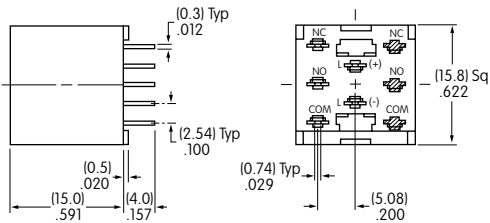

AT712 Double Pole • Straight PC Terminals

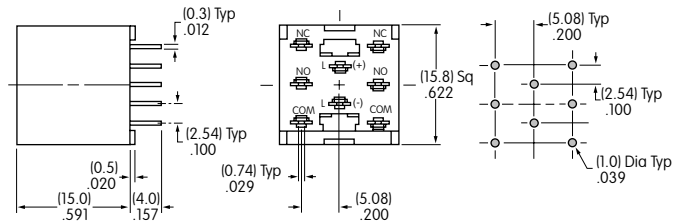

Note: Order adaptors separately.

AT9410 Splash Cover for Panel Seal

Materials:

- Lid: Polyvinyl chloride (PVC loses pliability below 0°C/32°F)
- Base: Polyethylene
- O-ring: NBR

Recommended Panel Thickness:
.039" ~ .138" (1.0mm ~ 3.5mm)

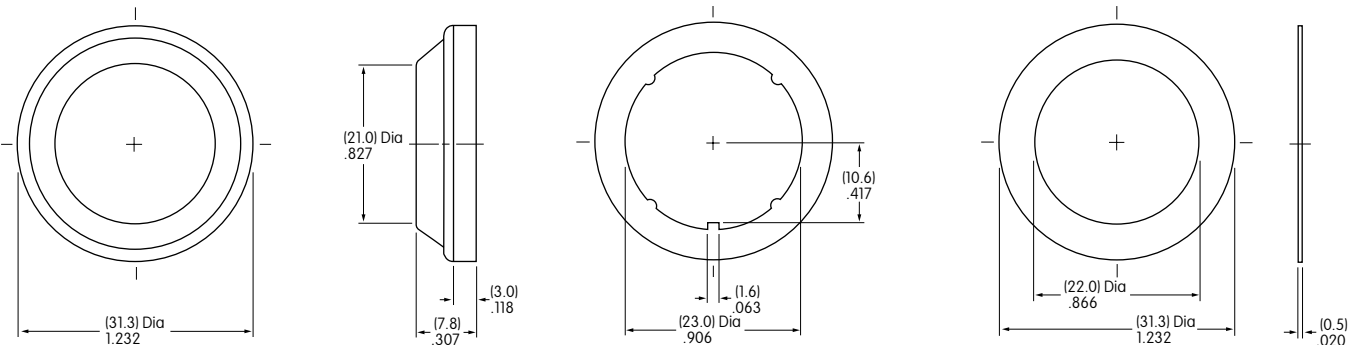
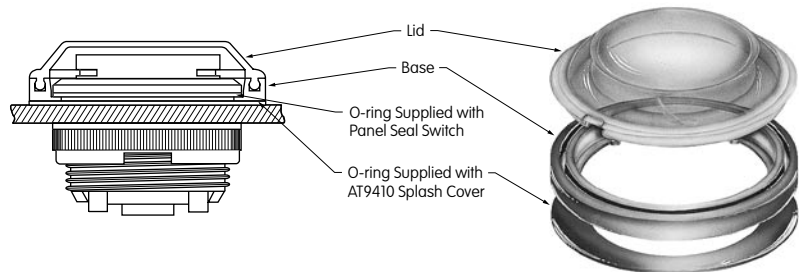

ASSEMBLY INSTRUCTIONS

Square
Match projection (C) on cap assembly with groove (C) inside switch.

Round & Rectangular
Match clip on cap assembly with receptacle inside switch.

Panel Seal
Match projection on cap assembly with notch inside switch.

Snap-in Mount

Snap-in clip holds all switches firmly in place. To mount round switch, match the antirotation projection on switch with guide cut in panel. Snap into panel cutout.

Panel Seal Bushing Mount

Insert switch from the front of the panel with the o-ring between the built-in bezel and the panel. Install mounting nut AT075 (supplied with switch) from the rear of the panel. Overtightening mounting nut may damage the switch housing.

AT109
Cap Extractor

AT112
Socket Wrench

LEGENDS

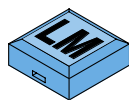

Easily create and submit your own legends using our new on-line Legend Maker.

Visit www.nkkswitches.com

For other legend support options, customers may either contact the factory and request the LB Legend Packet, or utilize the general information and basic specifications presented below.

Suggested Printable Area for LB Lens



Recommended Methods:
Laser Etch on clear lens;
Screen Print or Pad Print on lens.
Epoxy based ink is recommended.

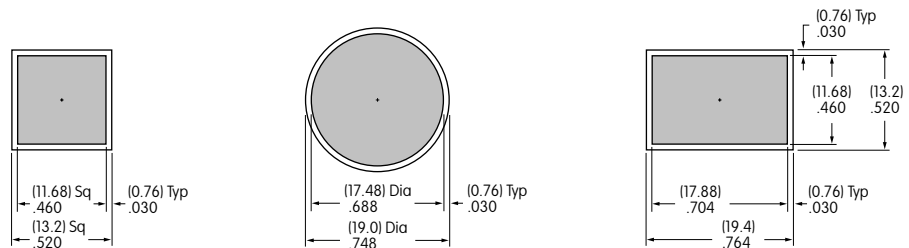

Shaded areas are printable areas.

Additional Method

Additional method for legends is engraving the cap. Maximum depth for engraving is .012" (0.3mm) on the cap lens. Enamel paint is recommended to fill the engraved area.