

## Thyristor Modules



**VRRM / VDRM** 800 to 1800V  
**ITAV** 90Amp

### Applications

- Power Converters
- Lighting Control
- DC Motor Control and Drives
- Heat and temperature control

### Features

- International standard package
- High Surge Capability
- Glass passivated chip
- Simple Mounting
- Heat transfer through aluminum oxide DBC ceramic isolated metal baseplate
- UL recognized applied for file no. E360040

### Circuit

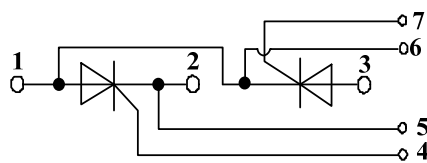

### Module Type

TYPE	VRRM	VRSM
MT90C08T1	800V	900V
MT90C12T1	1200V	1300V
MT90C16T1	1600V	1700V
MT90C18T1	1800V	1900V

### Maximum Ratings

Symbol	Conditions	Values	Units
$I_{TAV}$	Sine 180°; $T_c=85^\circ\text{C}$	90	A
$I_{TSM}$	$T_{VJ}=45^\circ\text{C}$ t=10ms, sine $T_{VJ}=125^\circ\text{C}$ t=10ms, sine	2000 1750	A
$i^2t$	$T_{VJ}=45^\circ\text{C}$ t=10ms, sine $T_{VJ}=125^\circ\text{C}$ t=10ms, sine	20000 15000	A <sup>2</sup> s
Visol	a.c.50HZ;r.m.s.;1min	3000	V
$T_{vj}$		-40 to 130	°C
$T_{stg}$		-40 to 125	°C
Mt	To terminals(M5)	$3 \pm 15\%$	Nm
Ms	To heatsink(M6)	$5 \pm 15\%$	Nm
di/dt	$T_{VJ}=T_{VJM}$ , $2/3V_{DRM}$ , $I_G=500\text{mA}$ $Tr<0.5\mu\text{s}$ , $tp>6\mu\text{s}$	150	A/ $\mu\text{s}$
dv/dt	$T_J=T_{VJM}$ , $2/3V_{DRM}$ , linear voltage rise	1000	V/ $\mu\text{s}$
a	Maximum allowable acceleration	50	m/s <sup>2</sup>
Weight	Module(Approximately)	100	g

### Thermal Characteristics

Symbol	Conditions	Values	Units
Rth(j-c)	Cont.;per thyristor / per module	0.28/0.14	°C/W
Rth(c-s)	per thyristor / per module	0.2/0.1	°C/W

## Electrical Characteristics

Symbol	Conditions	Values			Units
		Min.	Typ.	Max.	
$V_{TM}$	$T=25^{\circ}\text{C}$ $I_{TM}=300\text{A}$			1.65	V
$I_{RRM}/I_{DRM}$	$T_{VJ}=T_{VJM}$ , $V_R=V_{RRM}$ , $V_D=V_{DRM}$			20	mA
$V_{TO}$	For power-loss calculations only ( $T_{VJ}=125^{\circ}\text{C}$ )			0.9	V
$r_T$	$T_{VJ}=T_{VJM}$			2	m $\Omega$
$V_{GT}$	$T_{VJ}=25^{\circ}\text{C}$ , $V_D=6\text{V}$			3	V
$I_{GT}$	$T_{VJ}=25^{\circ}\text{C}$ , $V_D=6\text{V}$			150	mA
$V_{GD}$	$T_{VJ}=125^{\circ}\text{C}$ , $V_D=2/3V_{DRM}$			0.25	V
$I_{GD}$	$T_{VJ}=125^{\circ}\text{C}$ , $V_D=2/3V_{DRM}$			6	mA
$I_L$	$T_{VJ}=25^{\circ}\text{C}$ , $R_G=33\ \Omega$		300	600	mA
$I_H$	$T_{VJ}=25^{\circ}\text{C}$ , $V_D=6\text{V}$		150	250	mA
tg $d$	$T_{VJ}=25^{\circ}\text{C}$ , $I_G=1\text{A}$ , $di_G/dt=1\text{A}/\mu\text{s}$		1		$\mu\text{s}$
tq	$T_{VJ}=T_{VJM}$		100		$\mu\text{s}$

## Performance Curves

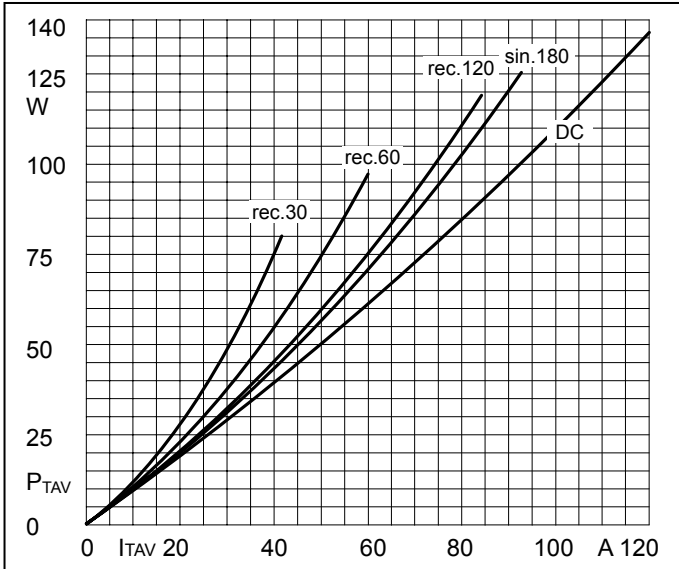

**Fig1. Power dissipation**

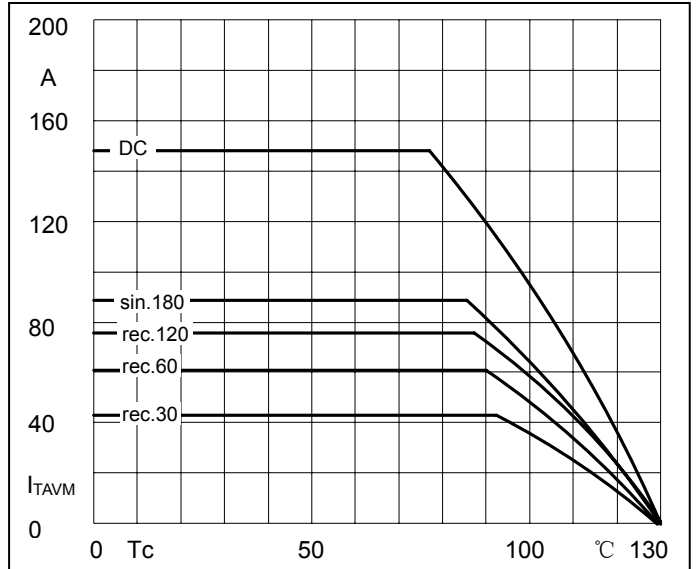

**Fig2. Forward Current Derating Curve**

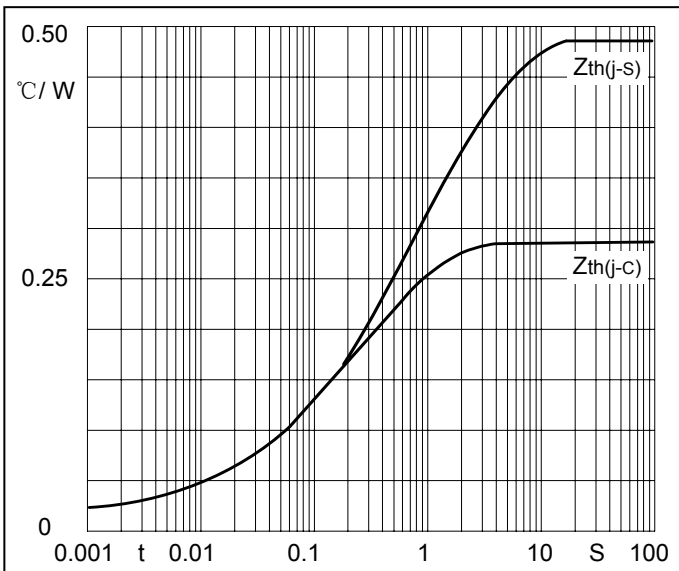

**Fig3. Transient thermal impedance**

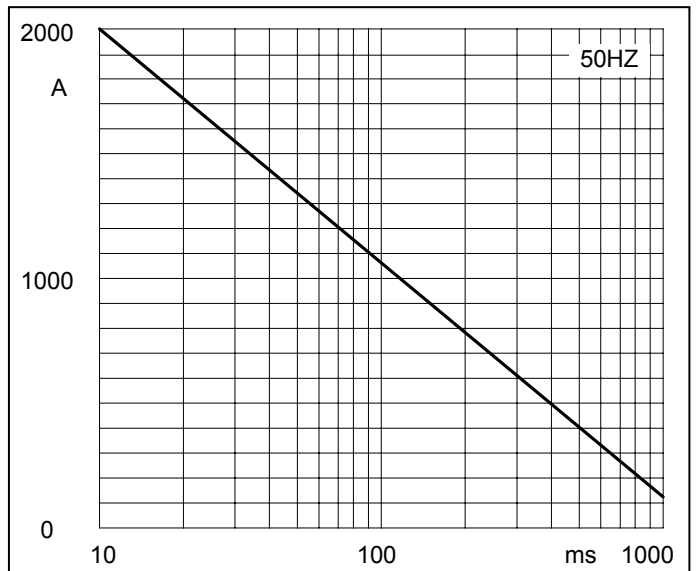

**Fig4. Max Non-Repetitive Forward Surge Current**

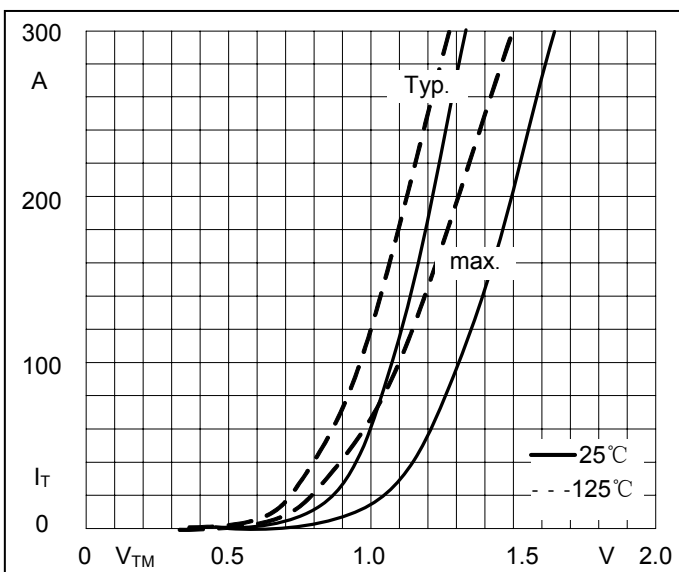

**Fig5. Forward Characteristics**

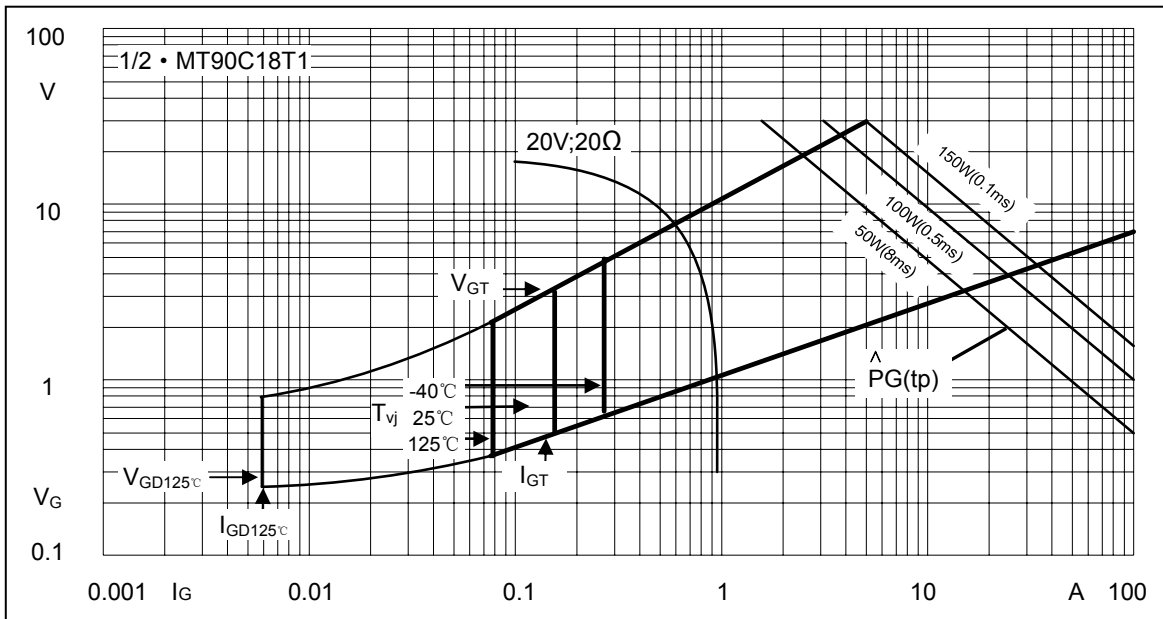
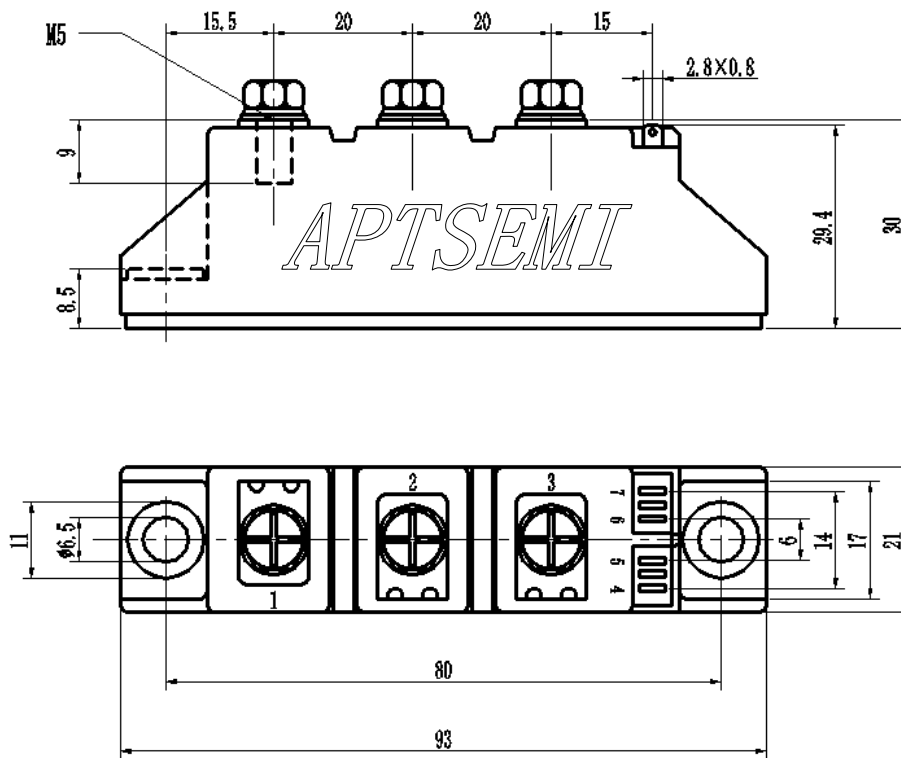

Fig6. Gate trigger Characteristics

## Package Outline Information

### CASE: T1



Dimensions in mm