



TAI-SAW TECHNOLOGY CO., LTD.

No. 3, Industrial 2nd Rd., Ping-Chen Industrial District,
Taoyuan, 324, Taiwan, R.O.C.

TEL: 886-3-4690038 FAX: 886-3-4697532

E-mail: tstsales@mail.taisaw.com Web: www.taisaw.com

Product Specifications Approval Sheet

Product Description: SAW IF Filter 36.17MHz for Digital TV

TST Part No.: TB0797A

Customer Part No.: _____

Customer signature required
Company: _____
Division: _____
Approved by : _____
Date: _____

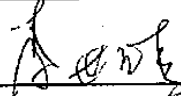
Checked by: Kazuma Lee 

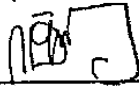
Approved by: Francis Chen 

Date: 2009, 08/05

1. Customer signed back is required before TST can proceed with sample build and receive orders.
2. Orders received without customer signed back will be regarded as agreement on the specifications.
3. Any specifications changes must be approved upon by both parties and a new revision of specifications shall be released to reflect the changes.



TAI-SAW TECHNOLOGY CO., LTD.

No.3, Industrial 2nd Rd., Ping-Chen Industrial District, Taoyuan, Taiwan, R.O.C.

TEL : 886-3-4690038 FAX : 886-3-4697532

E-mail : tstsales@ms52.hinet.net Web: www.taisaw.com

IF SAW Filter 36.17 MHz

MODEL NO.: TB0797A

REV. NO.:1

A. FEATURES:

1. IF Filter for Digital TV

B. MAXIMUM RATING:

1. DC voltage: 12 V.

2. AC voltage: 10 V.

3. Storage Temperature: -40°C to +85 °C.

4. Operating Temperature: -25 °C to +65 °C

Terminating source impedance $Z_S=50\Omega$

Terminating load impedance $Z_L=2k\Omega//3\text{ pF}$

C. ELECTRICAL CHARACTERISTICS:

Attenuation (ref. : 36.17 MHz): (Switching pin2 connected to ground)

	MIN.	TYP.	MAX.	
Insertion attenuation Reference level for the Following data 36.17 MHz	-	20.5	22.5	dB
1.5dB Pass Bandwidth	7.2	7.5	7.8	MHz
3.0dB Pass Bandwidth	7.4	7.8	8.2	MHz
15 dB Pass Bandwidth	8.4	8.9	9.4	
30dB Pass Bandwidth	8.8	9.4	10.0	MHz
Lower side lobe 25.00 to 31.15 MHz	33.0	36.0	-	dB
Upper side lobe 41.15 to 42.50 MHz	27.0	30.0	-	dB
42.50 to 45.00 MHz	35.0	40.0	-	dB
Group delay ripple (p-p) 32.25 to 40.05 MHz	-	50	-	ns
Temperature Coefficient of frequency	-	-72.0	-	ppm/K

(Witching pin2 connected to pin 1)

	MIN.	TYP.	MAX.	
Insertion attenuation Reference level for the Following data 36.17 MHz	-	20.5	22.5	dB
1.5dB Pass Bandwidth	6.4	6.7	7.0	MHz
3.0dB Pass Bandwidth	6.5	7.0	7.5	MHz
15 dB Pass Bandwidth	7.5	8.0	8.5	
30dB Pass Bandwidth	7.9	8.5	9.1	MHz
Lower side lobe 25.00 to 31.55 MHz	31.0	36.0	-	dB
Upper side lobe 40.75 to 45.00 MHz	30.0	33.0	-	dB
Group delay ripple (p-p) 32.75 to 39.55 MHz	-	50	-	ns
Temperature Coefficient of frequency	-	-72.0	-	ppm/K

RoHS Compliant
Lead free
Lead-free soldering

D.FREQUENCY CHARACTERISTICS:

Characteristics of channel 1 (Switching pin2 connected to ground)

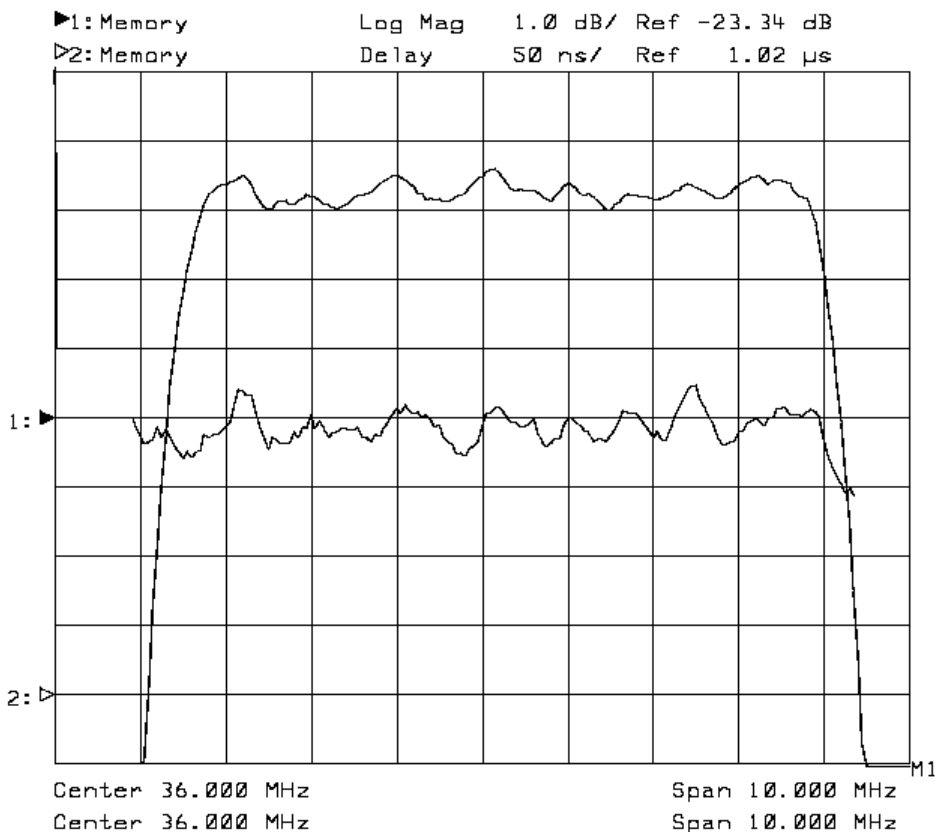
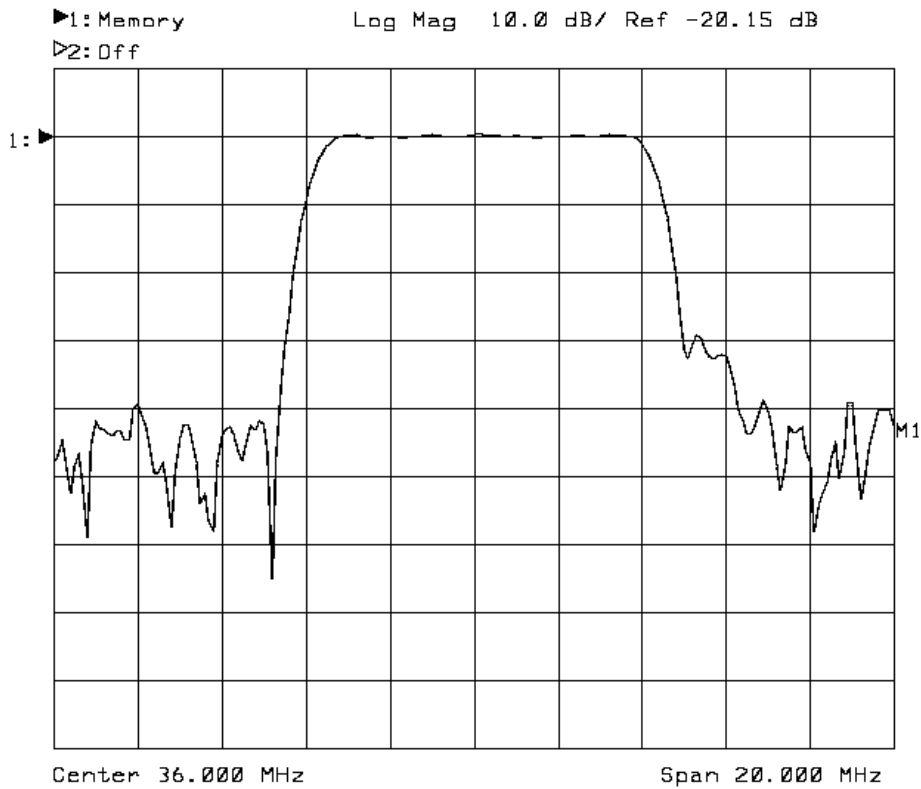

Characteristics of channel 2 (Switching pin2 connected to pin1)

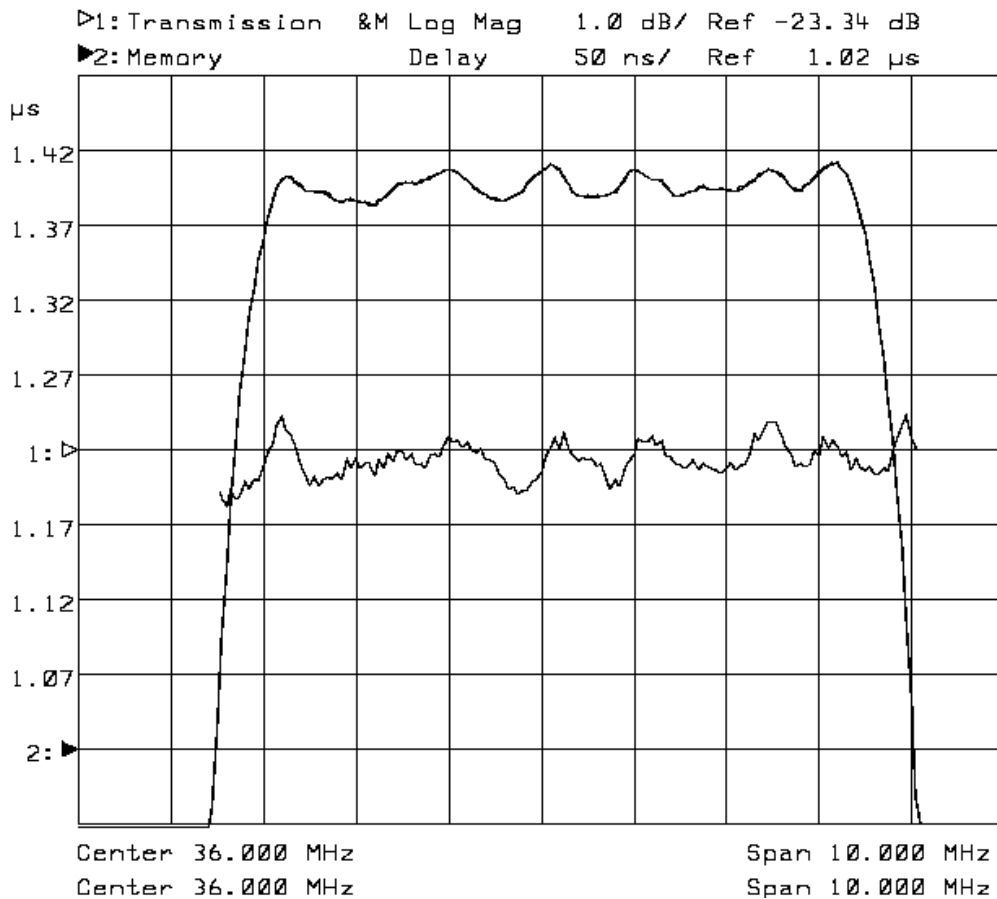
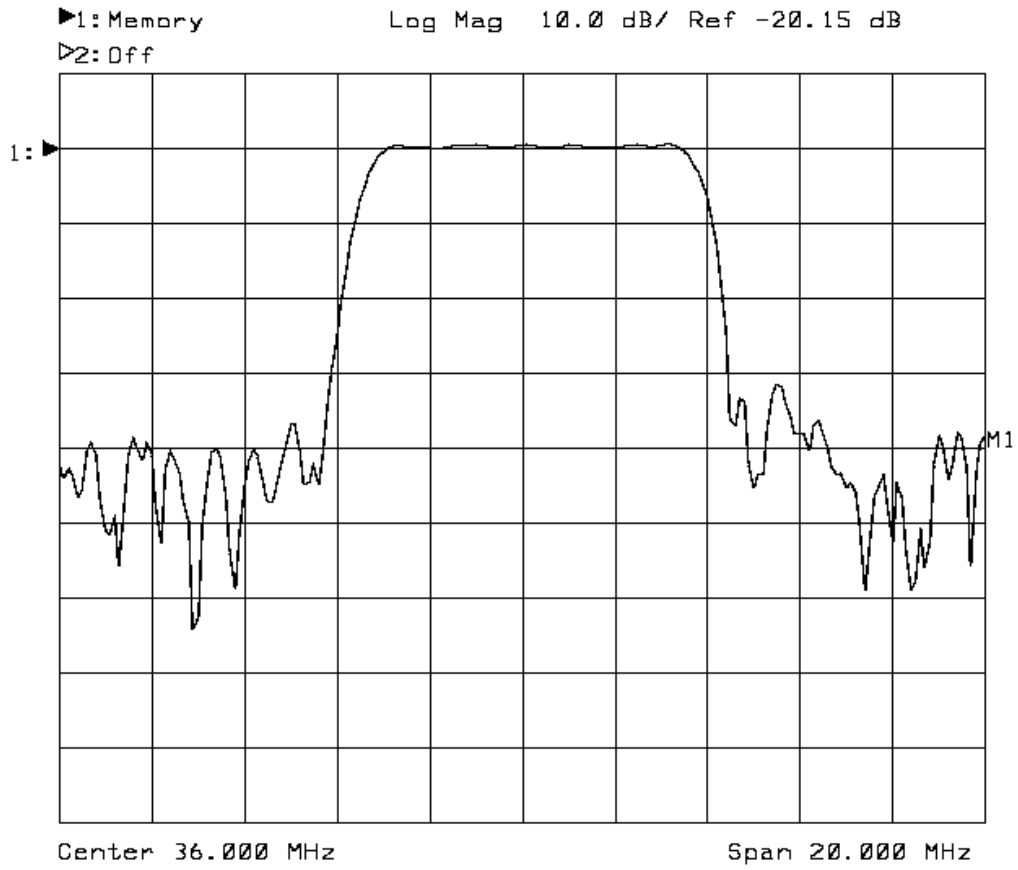

E. TEST CIRCUIT

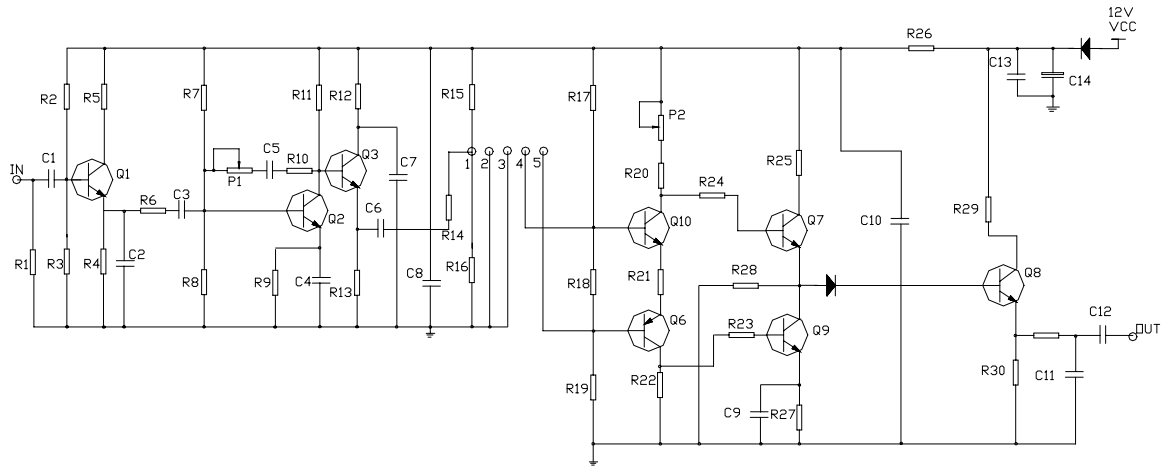

E. Outline Drawing:

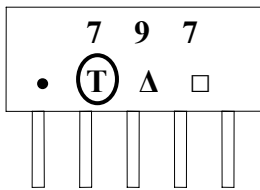

Pin No. Functions

1. Input
2. Switching Input
3. Chip carrier-Ground
4. Output
5. Output

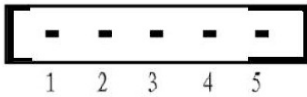

□ : Week Code (Follow the table from planner each year)

△ : Product / Year Code

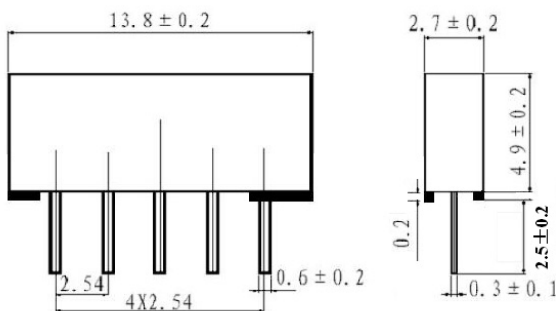

Year	2005 2009	2006 2010	2007 2011	2008 2012
Product Code	B	b	<u>B</u>	<u>b</u>