

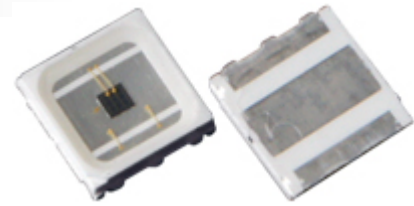

SMB1N-880

- Infrared High Power LED
- 880 nm, 320 mW
- SMD package, PA9T
- Dimension: 5.0 x 5.2 x 1.0 mm
- Viewing Angle: 128°



Description



SMB1N-880 is a surface mount AlGaAs High Power LED with a typical peak wavelength of **880 nm** and radiation of **320 mW**. It comes in SMD package (PA9T) with silver plated soldering pads (lead free solderable), copper heat sink, and molded with silicone resin.

Maximum Ratings ($T_{CASE}=25^{\circ}C$)

Parameter	Symbol	Values		Unit
		Min.	Max.	
Power Dissipation	P_D		2000	mW
Forward Current	I_F		1000	mA
Pulse Forward Current * ¹	I_{FP}		3000	mA
Reverse Voltage	V_F		5	V
Thermal Resistance	R_{THJA}		10	KW
Junction Temperature	T_J		120	°C
Operating Temperature	T_{CASE}	- 40	+ 100	°C
Storage Temperature	T_{STG}	- 40	+ 100	°C
Lead Solder Temperature * ²	T_{SLD}		+ 250	°C

*¹ duty=1%, pulse width = 10 μ s

*² must be completed within 5 seconds

Electro-Optical Characteristics ($T_{CASE}=25^{\circ}C$)

Parameter	Symbol	Conditions	Values			Unit
			Min.	Typ.	Max.	
Peak Wavelength	λ_P	$I_F=800mA$	870	880	890	nm
Half Width	$\Delta\lambda$	$I_F=800mA$		50		nm
Forward Voltage	V_F	$I_F=800mA$		1.7	2.2	V
	V_{FP}	$I_{FP}=3A$		2.8		
Radiated Power * ¹	P_O	$I_F=800mA$	240	320		mW
		$I_{FP}=3A$		1100		
Radiant Intensity * ²	I_E	$I_F=800mA$		100		mW/sr
		$I_{FP}=3A$		360		
Viewing Angle	φ	$I_F=100mA$		128		deg.
Rise Time	t_R	$I_F=800mA$		40		ns
Fall Time	t_F	$I_F=800mA$		40		ns

*¹ measured by S3584-08

*² measured by CIE127-2007 Condition B



Typical Performance Curves

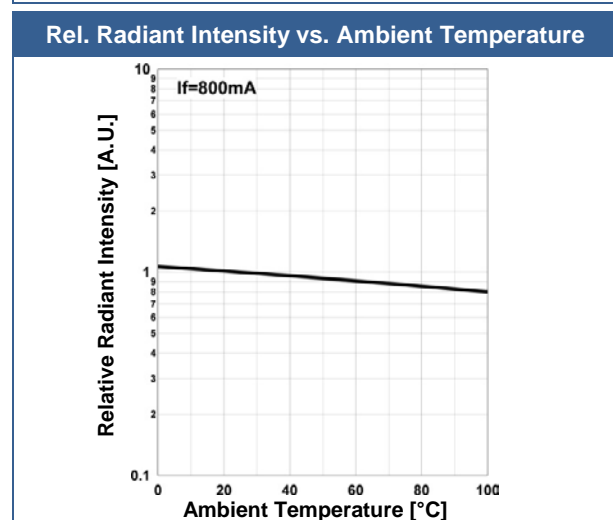
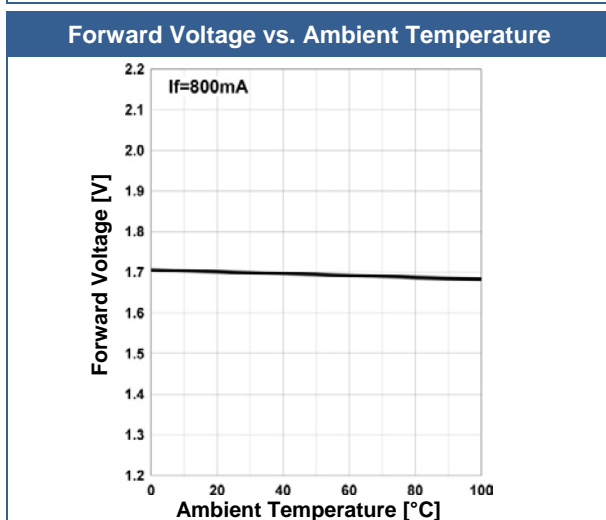
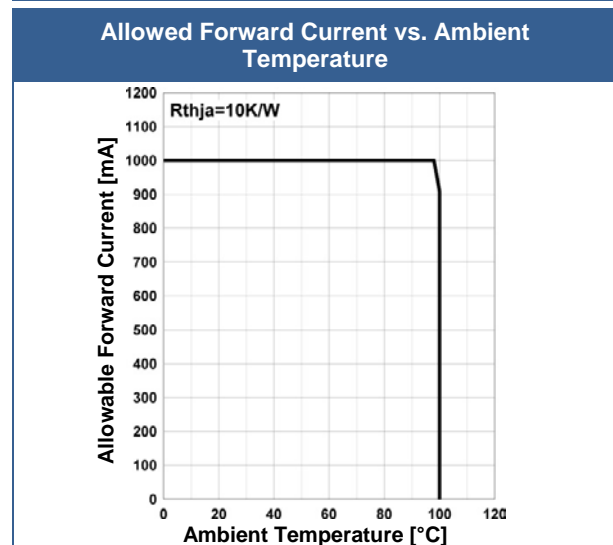
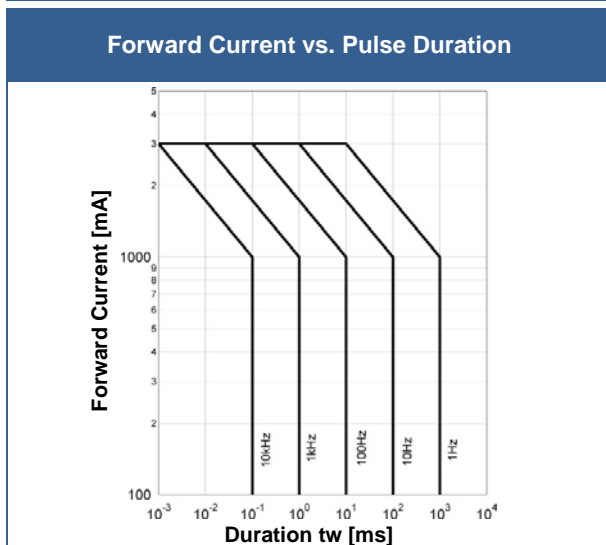
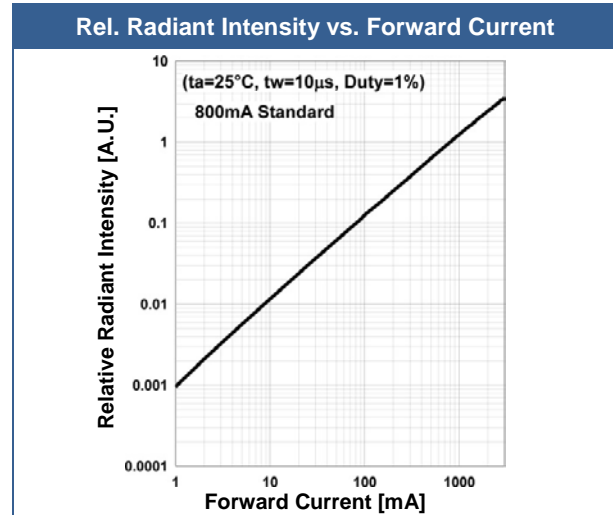
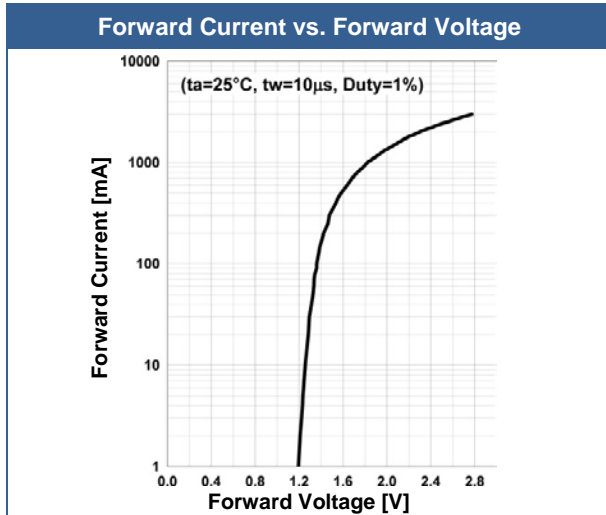



Peak Wavelength vs. Ambient Temperature

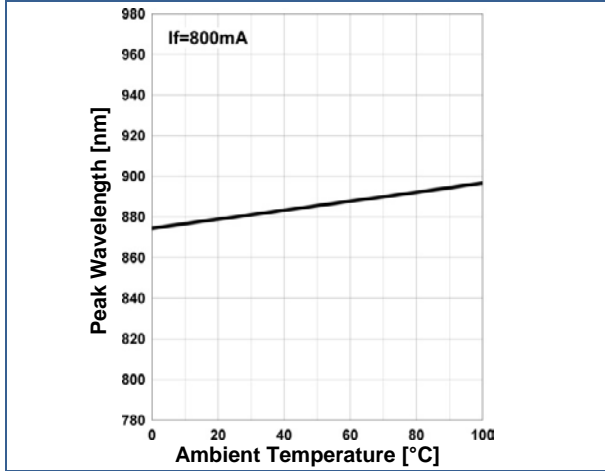

Relative Spectral Emission

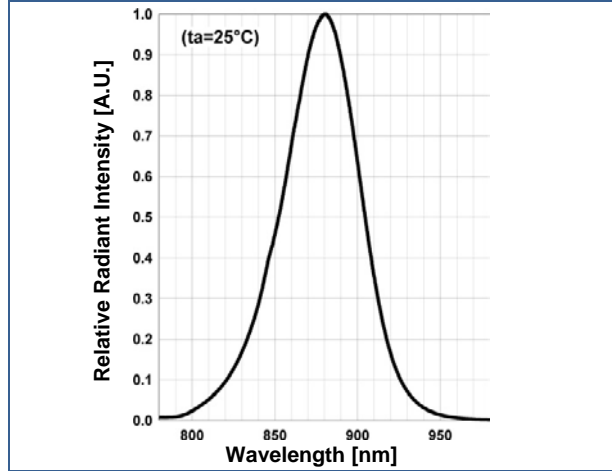

Radiation Characteristics

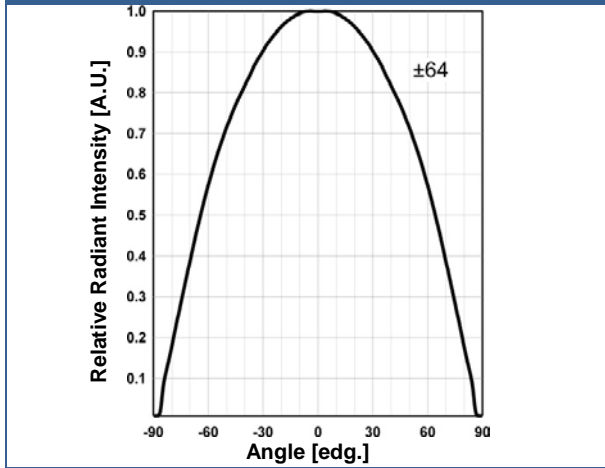

Radiation Characteristics

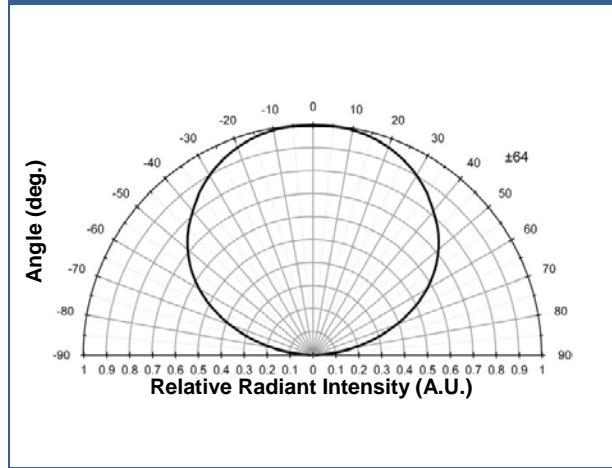

Outline Dimensions

SMB1N

flat

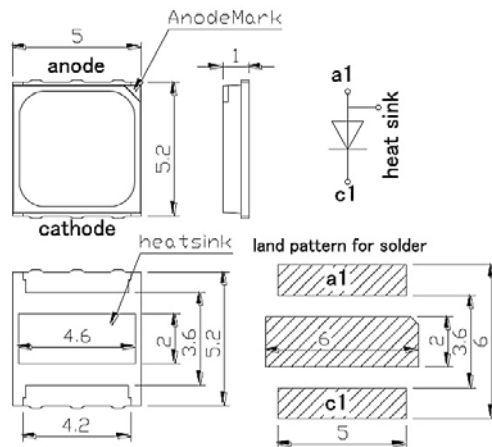

Lead	Description
Pin a1	LED Anode
Pin c1	LED Cathode

All Dimensions in mm



Precautions

Soldering:

- Do avoid overheating of the LED
- Do avoid electrostatic discharge (ESD)
- Do avoid mechanical stress, shock, and vibration
- Do only use non-corrosive flux
- Do not apply current to the LED until it has cooled down to room temperature after soldering

Recommended soldering conditions:

This LED is designed to be reflow soldered on to a PCB. If dip soldered or hand soldered, its reliability cannot be guaranteed.

Nitrogen reflow soldering is recommended. Air flow soldering conditions can cause optical degradation, caused by heat and/or atmosphere.

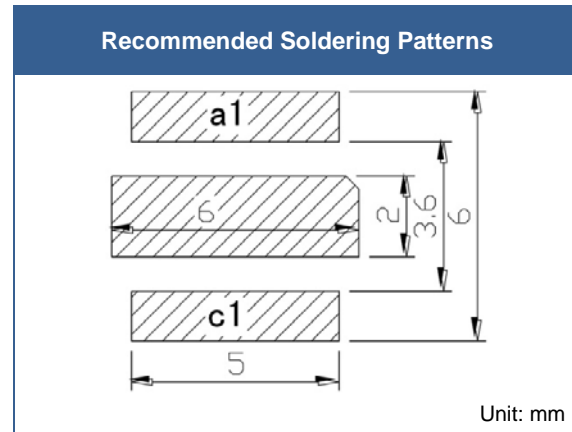
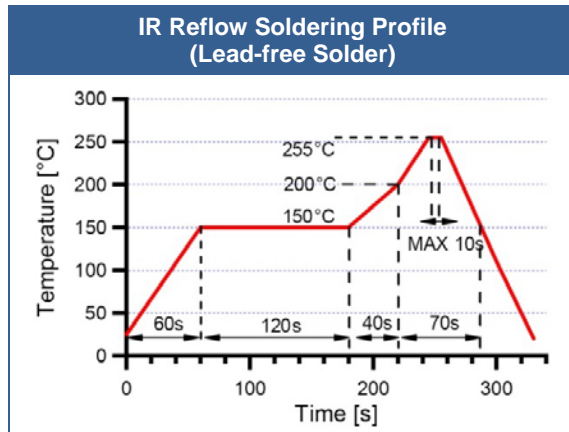

Above table specifies the maximum allowed duration and temperature during soldering. It is strongly advised to perform soldering at the shortest time and lowest temperature possible.

Cleaning:

Cleaning with isopropyl alcohol, propanol, or ethyl alcohol is recommended

DO NOT USE acetone, chloroform, trichloroethylene, or MKS

DO NOT USE ultrasonic cleaners

Static Electricity:

LEDs are sensitive to electrostatic discharge (ESD). Precautions against ESD must be taken when handling or operating these LEDs. Surge voltage or electrostatic discharge can result in complete failure of the device.

Radiation:

During operation these LEDs do emit **high intensity light**, which is hazardous to skin and eyes, and may cause cancer. Do avoid exposure to the emitted light. **Protective glasses are recommended.** It is further advised to attach a warning label on products/systems.

Operation:

Do only operate LEDs with a current source.

Running these LEDs from a voltage source will result in complete failure of the device.

Current of a LED is an exponential function of the voltage across it. Usage of current regulated drive circuits is mandatory.