

DESCRIPTION:

The B336 series with built-in I.C. which flashes the lamp on or off, can be driven directly by standard TTL and CMOS circuits without the need for external switching circuit.

The semi-conductor materials used are:

GaP for (B336VGC/VGD)

GaAlAs for (B336HR3C/HR3D, B336UR1C/UR1D)

GaAsP/GaP for (B336VYC/VYD)

ABSOLUTE MAXIMUM RATINGS: (Ta=25°C)

Reverse Voltage	5 Volt
Reverse Current (Vr =5V)	100μA
Operating Temperature Range	-40°C To 85°C
Storage Temperature Range	-40°C To 100°C
Lead Soldering Temperature (1.6mm (1/16)From Body)	260°C For 5 Seconds

NOTES : 1. All dimensions are in millimeters.

2. Lead spacing is measured where the leads emerge from the package.

3. Protuded resin under flange is 1.5 mm (0.059") Max.

4. Specifications are subject to change without notice.

PACKAGE DIMENSIONS

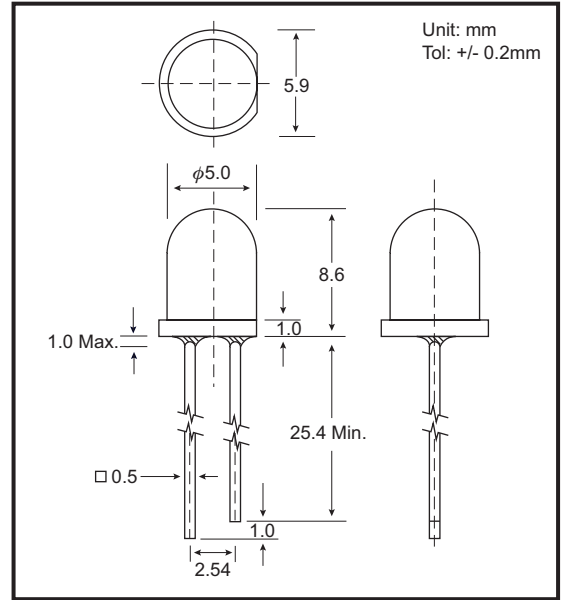

PART NO. SELECTION AND APPLICATION INFORMATION (RATINGS AT 25°C AMBIENT)

Part No.	Emitted Color	Lens Color	Peak Wavelength λp (nm)	Operating Voltage		Rec. If (mA).	Output Sink Current Typ (mA)	Output Source Current Typ (mA)	Blinking Frequency		View Angle 2θ1/2(Deg)
				Min	Max				Min	Max	
GB-B336HR3D	Super Red	Red Diffused	660	3.0	10	10-20	35	25	2.0	2.8	40
GB-B336UR1D	Super Red	Red Diffused	660	3.0	10	10-20	35	25	2.0	2.8	40
GB-B336VGD	Super Green	Green Diffused	565	3.0	10	10-20	45	25	2.0	2.8	40
GB-B336VYD	Super Yellow	Yellow Diffused	585	3.0	10	10-20	45	25	2.0	2.8	40
GB-B336HR3C	Super Red	Water Clear	660	3.0	10	10-20	35	25	2.0	2.8	20
GB-B336UR1C	Super Red	Water Clear	660	3.0	10	10-20	35	25	2.0	2.8	20
GB-B336VGC	Super Green	Water Clear	565	3.0	10	10-20	45	25	2.0	2.8	20
GB-B336VYC	Super Yellow	Water Clear	585	3.0	10	10-20	45	25	2.0	2.8	20

TESTING CONDITION FOR EACH PARAMETER :

PARAMETER:	SYMBOL	UNIT	TEST CONDITION
REVERSE VOLTAGE	Vr	VOLT	Vr = 5.0 Volt If = 20mA If = 20mA If = 20mA
REVERSE CURRENT	Ir	μA	
OUTPUT SINK CURRENT	Isink	mA	
OUTPUT SOURCE CURRENT	Isource	mA	
BLINKING FREQUENCY	Fblk	Hz	
RECOMMENDED OPERATING CURRENT	If (Rec)	mA	

