

Micro-Power Voltage Detectors

General Description

The RT9819 is a micro-power voltage detector supervising the power supply voltage level for microprocessors (μ P) or digital systems. It provides internally fixed threshold levels with 0.1V per step ranging from 1.2V to 5V, which covers most digital applications. It features low supply current of 3 μ A. The RT9819 performs supervisory function by sending out a reset signal whenever the V_{DD} voltage falls below a preset threshold level. This reset signal will last the whole period before V_{DD} recovering. Once V_{DD} recovered upcrossing the threshold level, the reset signal will be released after a certain delay time. RT9819 is provided in SC-70-3, SC-82 and SOT-23-3 packages.

Ordering Information

RT9819	□	□	□	□
	Package Type			
	U3 : SC-70-3			
	V : SOT-23-3			
	VL : SOT-23-3 (L-Type)			
	Y : SC-82			
	YR : SC-82 (R-Type)			
	Operating Temperature Range			
	P : Pb Free with Commercial Standard			
	G : Green (Halogen Free with Commercial Standard)			
	Threshold Voltage			
	12 : 1.2V			
	13 : 1.3V			
	:			
	49 : 4.9V			
	50 : 5.0V			
	Reset Active Timeout Period			
	A = 0ms ($\overline{\text{RESET}}$)			
	B = 55ms ($\overline{\text{RESET}}$)			
	C = 220ms ($\overline{\text{RESET}}$)			
	D = 450ms ($\overline{\text{RESET}}$)			
	E = 0ms (RESET)			
	F = 55ms (RESET)			
	G = 220ms (RESET)			
	H = 450ms (RESET)			

Note :

RichTek Pb-free and Green products are :

- ▶RoHS compliant and compatible with the current requirements of IPC/JEDEC J-STD-020.
- ▶Suitable for use in SnPb or Pb-free soldering processes.
- ▶100%matte tin (Sn) plating.

Features

- Internally Fixed Threshold 1.2V to 5V in 0.1V Step
- High Accuracy $\pm 1.5\%$
- Low Supply Current 3 μ A
- No External Components Required
- Quick Reset within 20 μ s
- Built-in Recovery Delay Include 0ms, 55ms, 220ms, 450ms Options
- Low Functional Supply Voltage 0.9V
- CMOS Push-Pull Output
- Small SC-70-3, SC-82 and SOT-23-3 Packages
- RoHS Compliant and 100% Lead (Pb)-Free

Applications

- Computers
- Controllers
- Intelligent Instruments
- Critical μ P and μ C Power Monitoring
- Portable/Battery-Powered Equipment

Marking Information

For marking information, contact our sales representative directly or through a RichTek distributor located in your area, otherwise visit our website for detail.

Typical Application Circuit

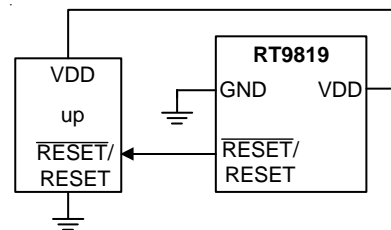

Pin Configurations

(TOP VIEW)

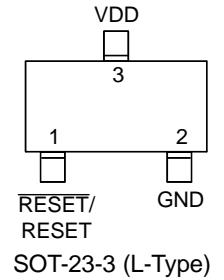
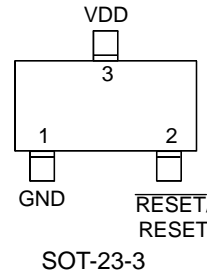
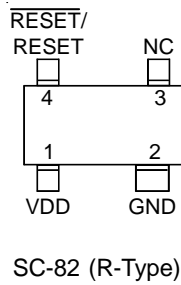
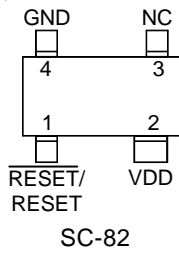
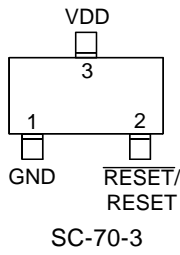

Note : There is no pin1 indicator on top mark for SC-82 type, and pin 1 will be lower left pin when reading top mark from left to right. Pin2 of SC-82 is wider than other pins.

Functional Pin Description

Pin Name	Pin Function
GND	Ground
RESET	Active Low Push-Pull Reset Output
RESET	Active High Push-Pull Reset Output
VDD	Power Pin

Function Block Diagram

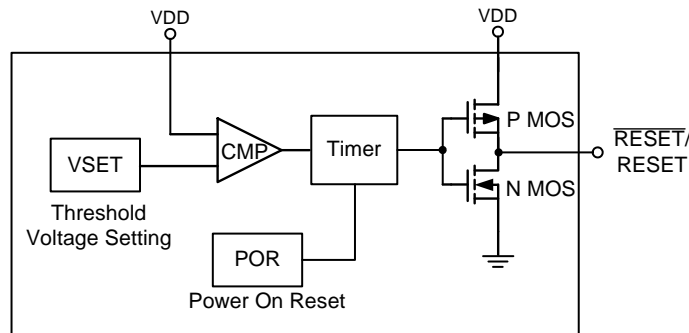

Absolute Maximum Ratings (Note 1)

- Terminal Voltage (with Respect to GND)
 V_{DD} ----- -0.3V to 6.0V
- All Other Inputs ----- -0.3V to $V_{DD}+0.3V$
- Input Current, I_{VDD} ----- 20mA
- Power Dissipation, PD @ $T_A = 25^\circ C$
 SC-70-3/SC-82 ----- 0.25W
 SOT-23-3 ----- 0.4W
- Package Thermal Resistance (Note 4)
 SC-70-3/SC-82, θ_{JA} ----- $400^\circ C/W$
 SOT-23-3, θ_{JA} ----- $250^\circ C/W$
- Lead Temperature (Soldering, 10sec.) ----- $260^\circ C$
- Storage Temperature Range ----- $-65^\circ C$ to $125^\circ C$
- ESD Susceptibility (Note 2)
 HBM (Human Body Mode) ----- 2kV
 MM (Machine Mode) ----- 200V

Recommended Operating Conditions (Note 3)

- Junction Temperature Range ----- $-40^\circ C$ to $125^\circ C$
- Ambient Temperature Range ----- $-40^\circ C$ to $85^\circ C$

Electrical Characteristics

($V_{DD} = 3V$, $T_A = 25^\circ C$, unless otherwise specified)

Parameter	Symbol	Test Conditions	Min	Typ	Max	Units
Operating V_{DD} (V_{OUT}) Range	V_{DD}	RT9819A/B/C/D	0.9	--	6	V
		RT9819E/F/G/H	1.1	--	6	
Supply Current	I_{DD}	$V_{TH} = 3V$, $V_{DD} = 4.5V$	--	3	8	μA
Reset Threshold	V_{TH}		--	1.2 to 5.0	--	V
Threshold Voltage Accuracy	ΔV_{TH}		-1.5	--	+1.5	%
Threshold Voltage Hysteresis	V_{HYS}		--	$0.01 V_{TH}$	--	V
V_{DD} Drop to Reset Delay	t_{RD}	Drop = $V_{TH} - 125mV$	--	20	--	μs
Reset Active Time Out Period	RT9819A/E	$V_{DD} \geq 1.02 \times V_{TH}$	--	0	--	ms
	RT9819B/F		35	55	75	ms
	RT9819C/G		143	220	297	ms
	RT9819D/H		292	450	608	ms
RESET Output Voltage Low	V_{OL}	$V_{DD} < V_{TH(MIN)}$, $I_{SINK} = 3.5mA$, $V_{TH} \geq 3V$	--	--	0.4	V
		$V_{DD} < V_{TH(MIN)}$, $I_{SINK} = 1.2mA$, $V_{TH} \geq 1.8V$	--	--	0.3	
		$V_{TH(MIN)} > V_{DD} > 1V$, $I_{SINK} = 0.5mA$	--	--	0.3	

To be continued

Parameter	Symbol	Test Conditions	Min	Typ	Max	Units
RESET Output Voltage High	V _{OH}	V _{DD} > V _{TH(MAX)} , I _{SOURCE} = 800μA, V _{TH} ≥ 3V	V _{DD} -1.5	--	--	V
		V _{DD} > V _{TH(MAX)} , I _{SOURCE} = 500μA, V _{TH} ≥ 1.8V	0.8 V _{DD}	--	--	
		V _{DD} > V _{TH(MAX)} , I _{SOURCE} = 200μA, V _{TH} ≥ 1.1V	0.8 V _{DD}	--	--	
RESET Output Voltage Low	V _{OL}	V _{DD} > V _{TH(MAX)} , I _{SINK} = 3.5mA, V _{TH} ≥ 3V	--	--	0.4	V
		V _{DD} > V _{TH(MAX)} , I _{SINK} = 1.2mA, V _{TH} ≥ 1.8V	--	--	0.3	
		V _{DD} > V _{TH(MAX)} , I _{SINK} = 0.5mA, V _{TH} ≥ 1.2V	--	--	0.3	
RESET Output Voltage High	V _{OH}	1.1V < V _{DD} < V _{TH(MIN)} , I _{SOURCE} = 200μA	0.8 V _{DD}	--	--	V
		1.8V < V _{DD} < V _{TH(MIN)} , I _{SOURCE} = 500μA	0.8 V _{DD}	--	--	
		3V < V _{DD} < V _{TH(MIN)} , I _{SOURCE} = 800μA	V _{DD} -1.5	--	--	

Note 1. Stresses listed as the above "Absolute Maximum Ratings" may cause permanent damage to the device. These are for stress ratings. Functional operation of the device at these or any other conditions beyond those indicated in the operational sections of the specifications is not implied. Exposure to absolute maximum rating conditions for extended periods may remain possibility to affect device reliability.

Note 2. Devices are ESD sensitive. Handling precaution recommended.

Note 3. The device is not guaranteed to function outside its operating conditions.

Note 4. θ_{JA} is measured in the natural convection at T_A = 25°C on a low effective thermal conductivity test board of JEDEC 51-3 thermal measurement standard.

Typical Operating Characteristics

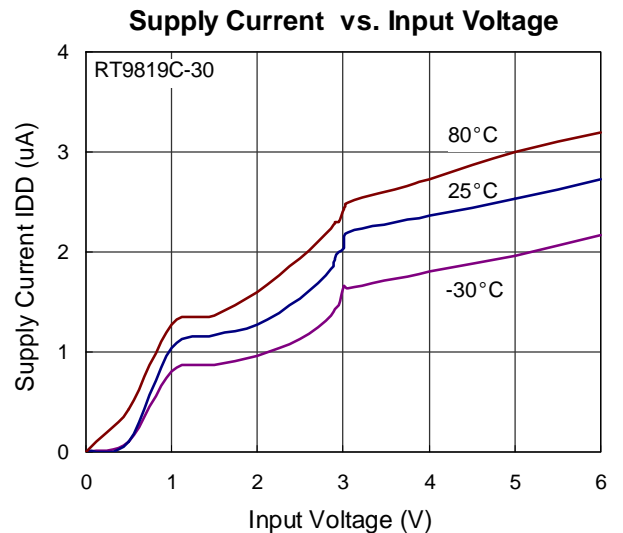
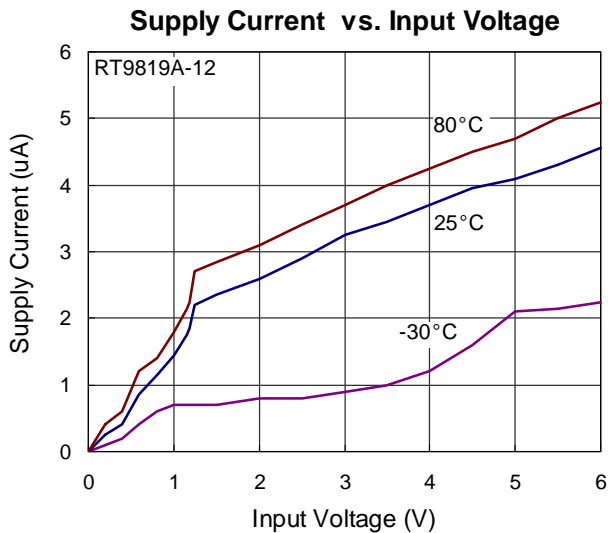
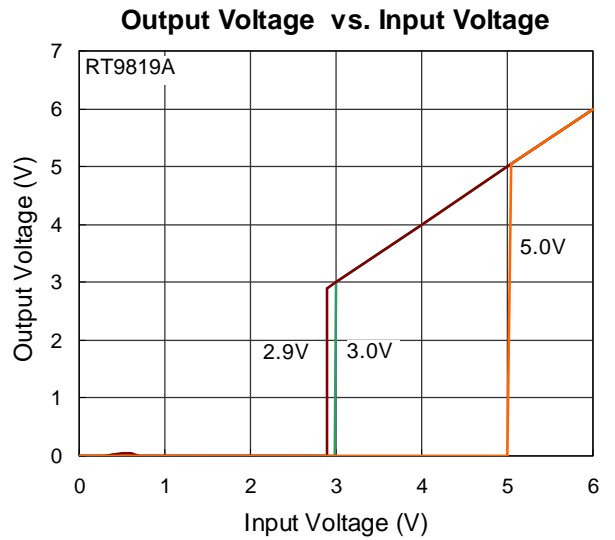
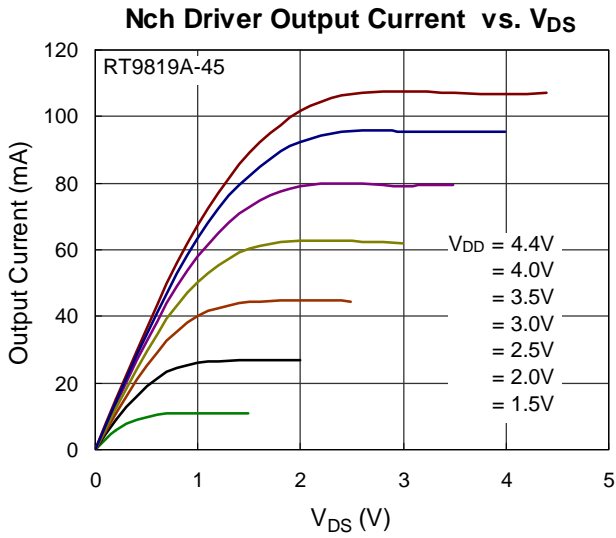
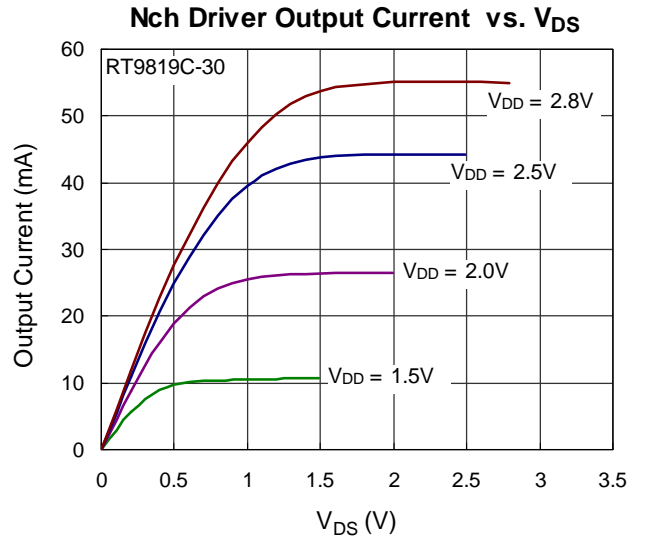
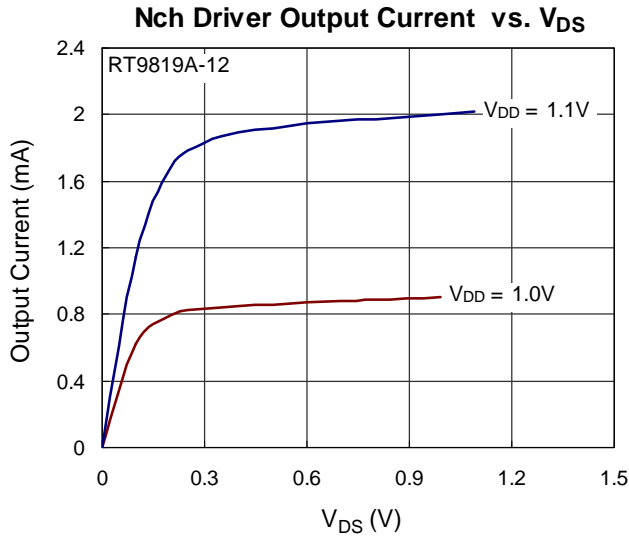

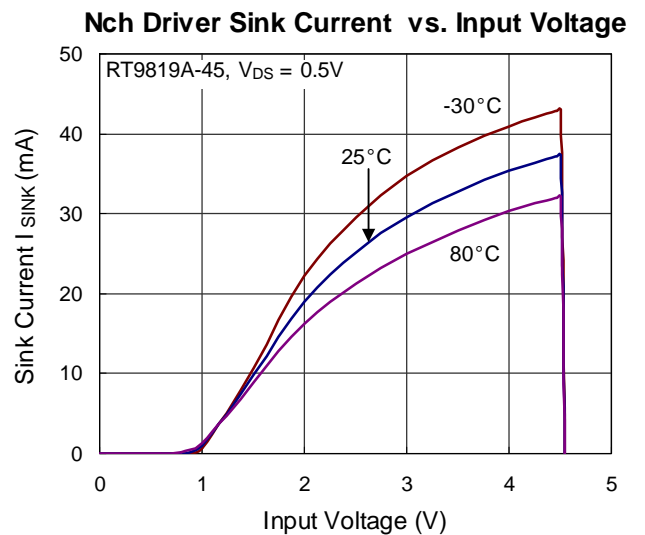
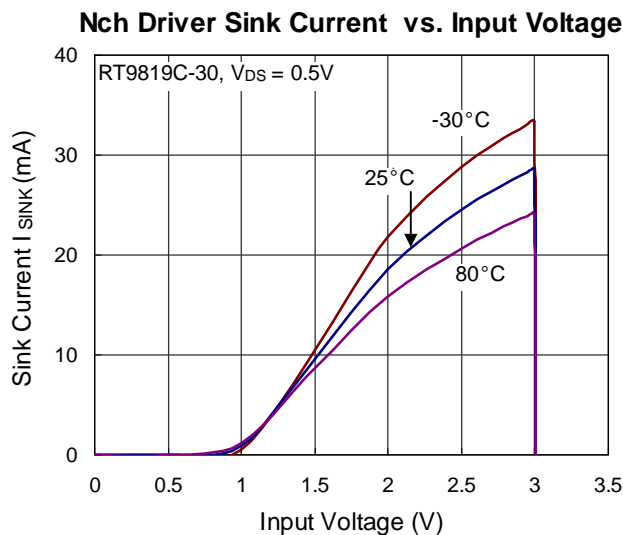
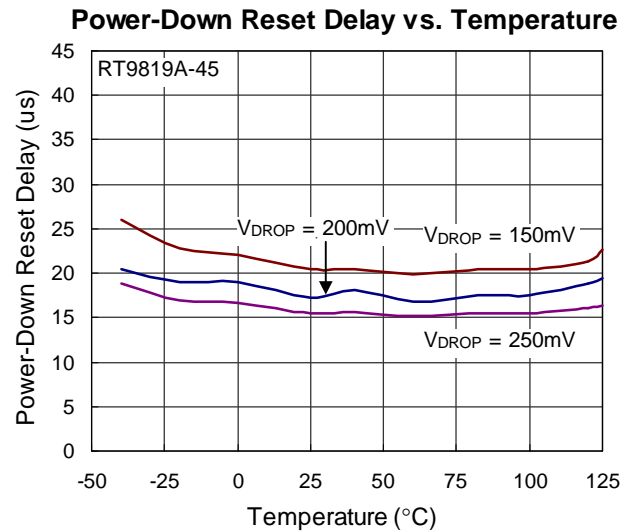
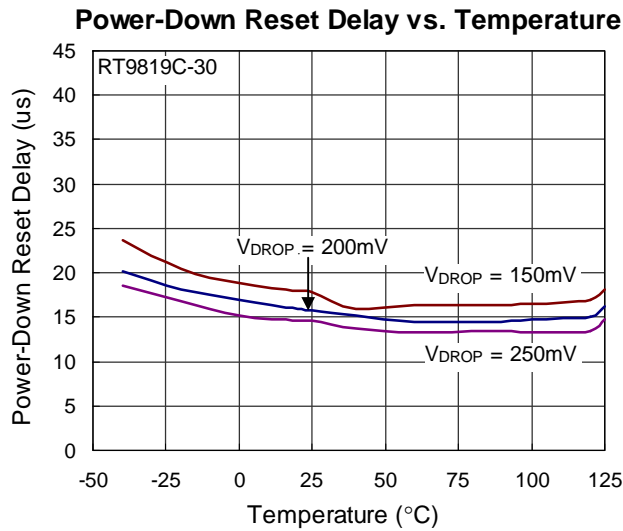
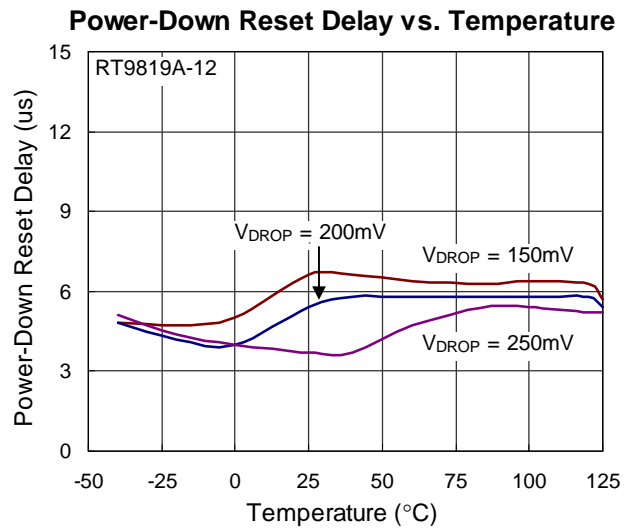
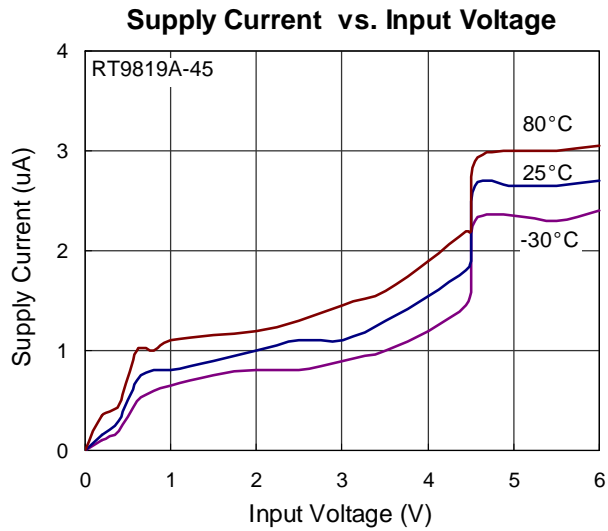

Reset Threshold Deviation vs. Temperature

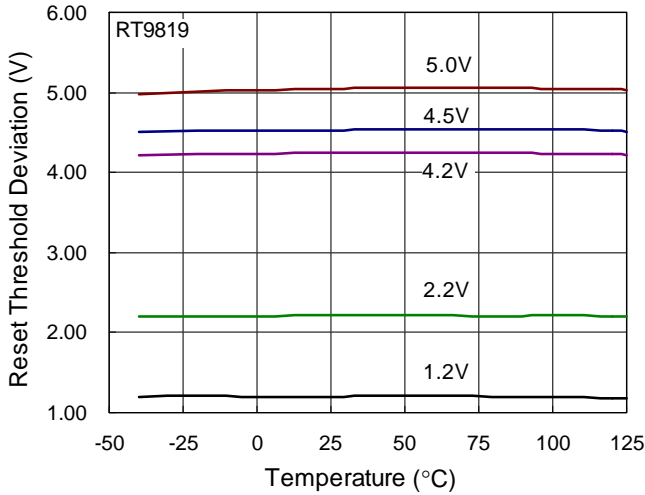

Pch Driver Output Current vs. Input Voltage

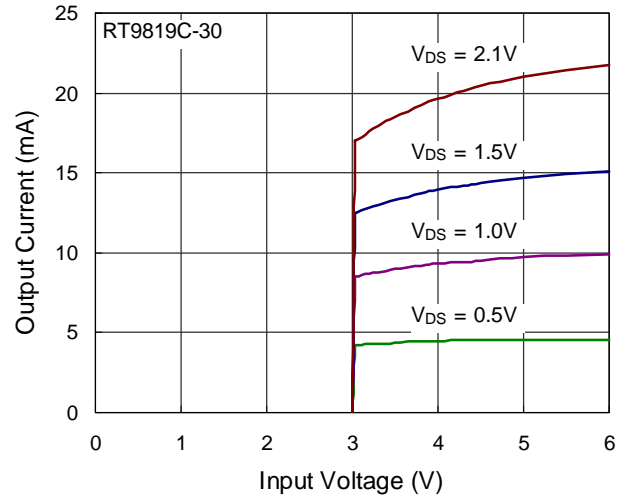

Power-Up Reset Time-Out vs. Temperature

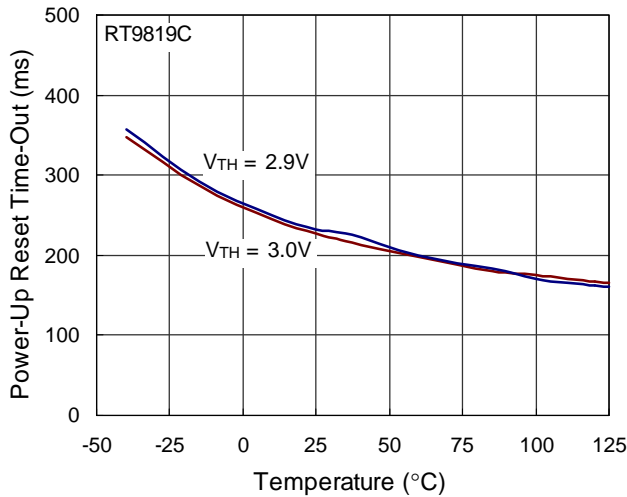

Power-Up Reset Time-Out vs. Temperature

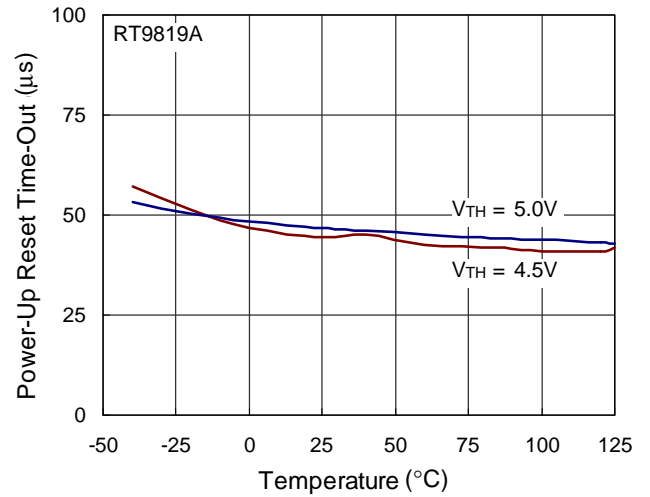

Output Delay Time vs. Load Capacitance

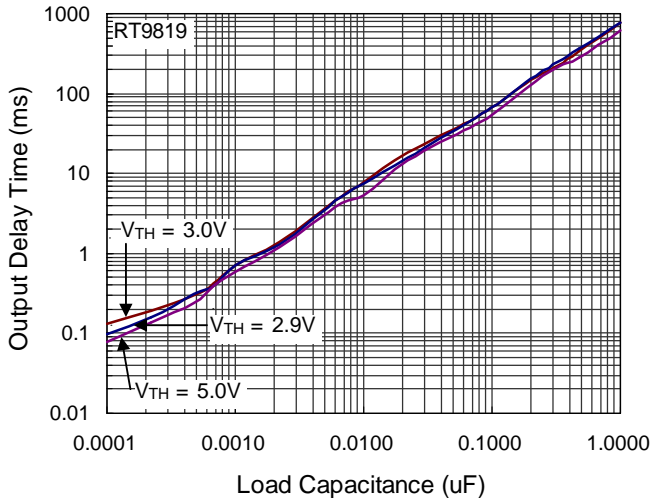

Nch Driver Output Current vs. VDS

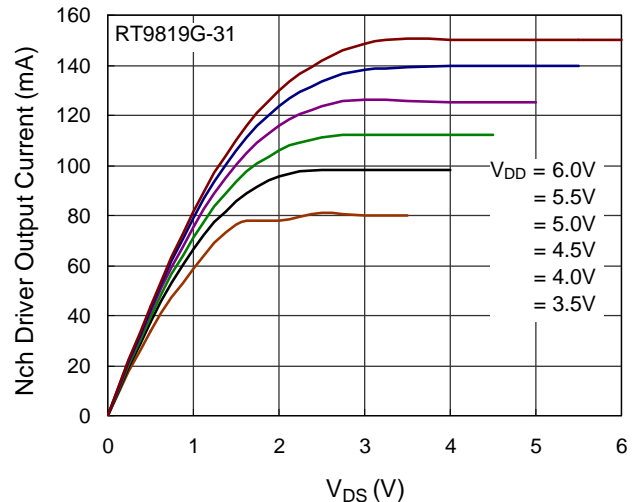

Nch Driver Output Current vs. Input Voltage

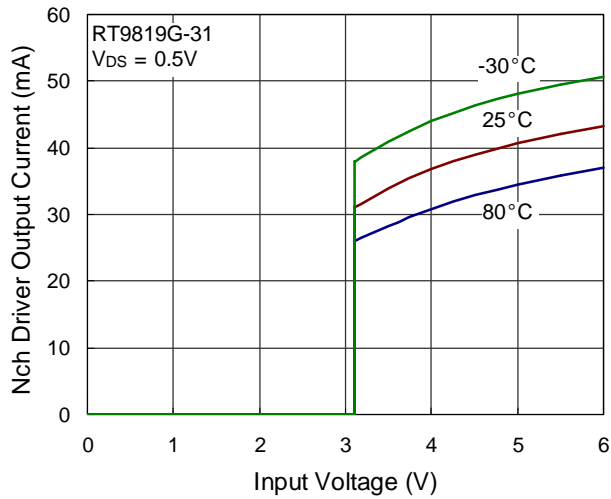

Power Down Reset Time-Out vs. Temperature

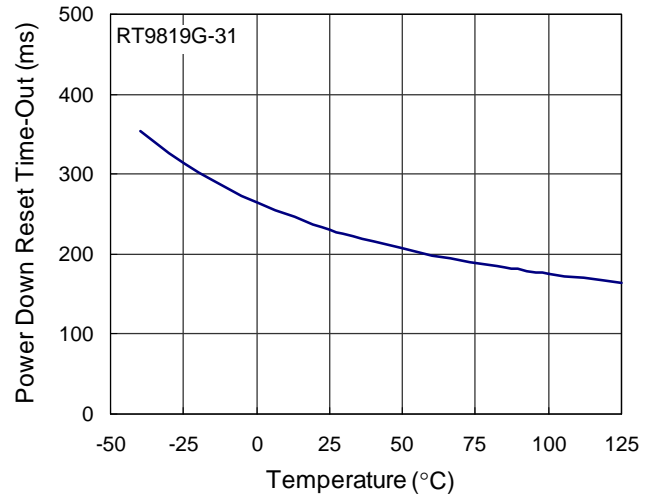

Output Voltage vs. Input Voltage

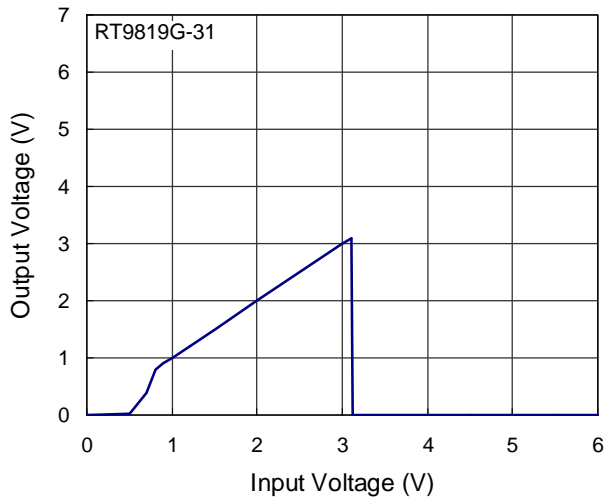

Power-Down Reset Time-Out vs. Temperature

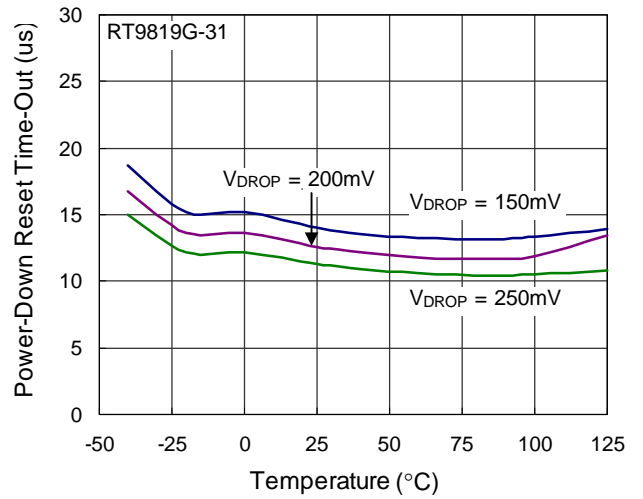

Application Information

Benefits of Highly Accurate Reset Threshold

Most μ P supervisor ICs have reset threshold voltages between 1% and 1.5% below the value of nominal supply voltages. This ensures a reset will not occur within 1% of the nominal supply, but will occur when the supply is 1.5% below nominal.

Outline Dimension

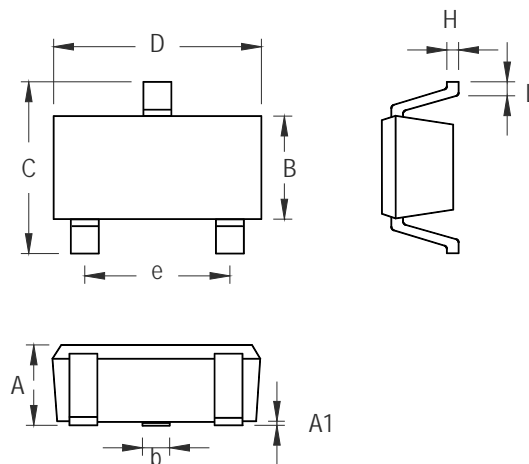

Symbol	Dimensions In Millimeters		Dimensions In Inches	
	Min	Max	Min	Max
A	0.800	1.100	0.031	0.044
A1	0.000	0.100	0.000	0.004
B	1.150	1.350	0.045	0.054
b	0.150	0.400	0.006	0.016
C	1.800	2.450	0.071	0.096
D	1.800	2.250	0.071	0.089
e	1.300		0.051	
H	0.080	0.260	0.003	0.010
L	0.210	0.460	0.008	0.018

SC-70-3 Surface Mount Package

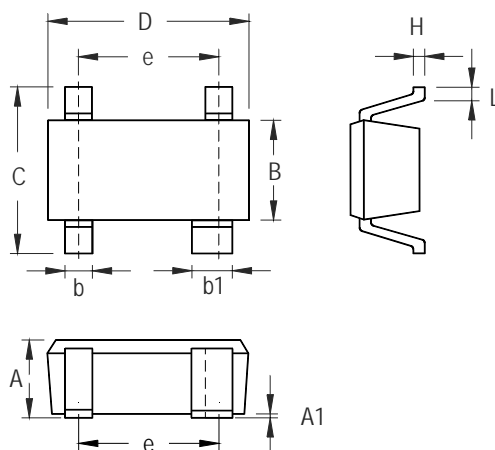

Symbol	Dimensions In Millimeters		Dimensions In Inches	
	Min	Max	Min	Max
A	0.800	1.100	0.031	0.043
A1	0.000	0.100	0.000	0.004
B	1.150	1.350	0.045	0.053
b	0.150	0.400	0.006	0.016
b1	0.350	0.500	0.014	0.020
C	1.800	2.450	0.071	0.096
D	1.800	2.200	0.071	0.087
e	1.300		0.051	
H	0.080	0.260	0.003	0.010
L	0.200	0.460	0.008	0.018

SC-82 Surface Mount Package

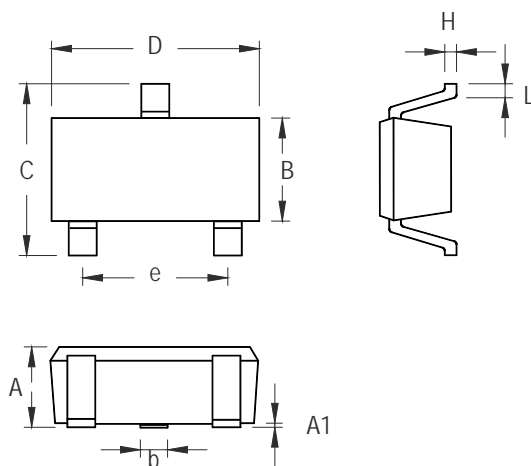

Symbol	Dimensions In Millimeters		Dimensions In Inches	
	Min	Max	Min	Max
A	0.889	1.295	0.035	0.051
A1	0.000	0.152	0.000	0.006
B	1.397	1.803	0.055	0.071
b	0.356	0.508	0.014	0.020
C	2.591	2.997	0.102	0.118
D	2.692	3.099	0.106	0.122
e	1.803	2.007	0.071	0.079
H	0.080	0.254	0.003	0.010
L	0.300	0.610	0.012	0.024

SOT-23-3 Surface Mount Package

Richtek Technology Corporation

Headquarter
 5F, No. 20, Taiyuen Street, Chupei City
 Hsinchu, Taiwan, R.O.C.
 Tel: (8863)5526789 Fax: (8863)5526611

Richtek Technology Corporation

Taipei Office (Marketing)
 8F, No. 137, Lane 235, Paochiao Road, Hsintien City
 Taipei County, Taiwan, R.O.C.
 Tel: (8862)89191466 Fax: (8862)89191465
 Email: marketing@richtek.com