

**OBSOLETE PRODUCT  
POSSIBLE SUBSTITUTE PRODUCT  
HA-2842, HA-2544**

**50MHz, Fast Settling, Unity Gain Stable, Video Operational Amplifier**

The HA-2841 is a wideband, unity gain stable, operational amplifier featuring a 50MHz unity gain bandwidth, and excellent DC specifications. This amplifier's performance is further enhanced through stable operation down to closed loop gains of +1, the inclusion of offset null controls, and by its excellent video performance.

The capabilities of the HA-2841 are ideally suited for high speed pulse and video amplifier circuits, where high slew rates and wide bandwidth are required. Gain flatness of 0.05dB, combined with differential gain and phase specifications of 0.03%, and 0.03 degrees, respectively, make the HA-2841 ideal for component and composite video applications.

A zener/nichrome based reference circuit, coupled with advanced laser trimming techniques, yields a supply current with a low temperature coefficient and low lot-to-lot variability. Tighter I<sub>CC</sub> control translates to more consistent AC parameters ensuring that units from each lot perform the same way, and easing the task of designing systems for wide temperature ranges. Critical AC parameters, Slew Rate and Bandwidth, each vary by less than ±5% over the industrial temperature range (see characteristic curves).

For military grade product, refer to the HA-2841/883 data sheet.

**HA-2841 (PDIP, SOIC)  
TOP VIEW**

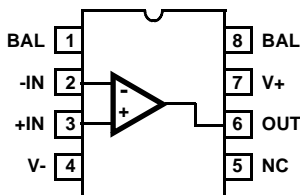

**Features**

- Low Supply Current . . . . . 10mA
- Low AC Variability Over Process and Temperature
- Unity Gain Bandwidth. . . . . 50MHz
- Gain Flatness to 10MHz. . . . . 0.05dB
- High Slew Rate . . . . . 240V/μs
- Low Offset Voltage. . . . . 1mV
- Fast Settling Time (0.1%). . . . . 90ns
- Differential Gain/Phase . . . . . 0.03%/0.03 Degrees
- Enhanced Replacement for AD841 and EL2041

**Applications**

- Pulse and Video Amplifiers
- Wideband Amplifiers
- High Speed Sample-Hold Circuits
- Fast, Precise D/A Converters
- High Speed A/D Input Buffer

**Part Number Information**

PART NUMBER (BRAND)	TEMP. RANGE (°C)	PACKAGE	PKG. NO.
HA3-2841-5	0 to 75	8 Ld PDIP	E8.3
HA9P2841-5 (H28415)	0 to 75	8 Ld SOIC	M8.15

# HA-2841

## Absolute Maximum Ratings

Voltage Between V+ and V- Terminals	35V
Differential Input Voltage	6V
Output Current (Note 3)	50mA
	10mA (50% Duty Cycle)

## Operating Conditions

Temperature Range	
HA-2841-5	0°C to 75°C
Recommended Supply Voltage Range	±6.5V to ±15V

CAUTION: Stresses above those listed in "Absolute Maximum Ratings" may cause permanent damage to the device. This is a stress only rating and operation of the device at these or any other conditions above those indicated in the operational sections of this specification is not implied.

## NOTES:

- Maximum power dissipation, including output load, must be designed to maintain the maximum junction temperature below 150°C for plastic packages.
- $\theta_{JA}$  is measured with the component mounted on an evaluation PC board in free air.
- $V_O = \pm 10V$ ,  $R_L$  unconnected. Output duty cycle must be reduced if  $I_{OUT} > 10mA$ .

## Thermal Information

Thermal Resistance (Typical, Note 2)	$\theta_{JA}$ (°C/W)
8 Lead PDIP Package	92
8 Lead SOIC Package	157
Maximum Junction Temperature (Die, Note 1)	175°C
Maximum Junction Temperature (Plastic Package)	150°C
Maximum Storage Temperature Range	-65°C to 150°C
Maximum Lead Temperature (Soldering 10s)	300°C
	(SOIC - Lead Tips Only)

## Electrical Specifications $V_{SUPPLY} = \pm 15V$ , $R_L = 1k\Omega$ , $C_L \leq 10pF$ , Unless Otherwise Specified

PARAMETER	TEST CONDITIONS	TEMP. (°C)	HA-2841-5			UNITS
			MIN	TYP	MAX	
<b>INPUT CHARACTERISTICS</b>						
Offset Voltage (Note 10)		25	-	1	3	mV
		Full	-	-	6	mV
Average Offset Voltage Drift		Full	-	14	-	$\mu V/^\circ C$
Bias Current (Note 10)		25	-	5	10	$\mu A$
		Full	-	8	15	$\mu A$
Average Bias Current Drift		Full	-	45	-	$nA/^\circ C$
Offset Current		25	-	0.5	1.0	$\mu A$
		Full	-	-	1.5	$\mu A$
Input Resistance		25	-	170	-	$k\Omega$
Input Capacitance		25	-	1	-	pF
Common Mode Range		Full	±10	-	-	V
Input Noise Voltage	10Hz to 1MHz	25	-	16	-	$\mu V_{RMS}$
Input Noise Voltage (Note 10)	$f = 1kHz$ , $R_{SOURCE} = 0\Omega$	25	-	16	-	$nV/\sqrt{Hz}$
Input Noise Current (Note 10)	$f = 1kHz$ , $R_{SOURCE} = 10k\Omega$	25	-	2	-	$pA/\sqrt{Hz}$
<b>TRANSFER CHARACTERISTICS</b>						
Large Signal Voltage Gain	$V_O = \pm 10V$	25	25	50	-	kV/V
		Full	10	30	-	kV/V
Common-Mode Rejection Ratio (Note 10)	$V_{CM} = \pm 10V$	Full	80	95	-	dB
Minimum Stable Gain		25	1	-	-	V/V
Gain Bandwidth Product (Notes 5, 10)		25	-	50	-	MHz
Gain Flatness to 5MHz (Note 10)	$R_L \geq 75\Omega$	25	-	±0.015	-	dB
Gain Flatness to 10MHz (Note 10)	$R_L \geq 500\Omega$	25	-	±0.05	-	dB
<b>OUTPUT CHARACTERISTICS</b>						
Output Voltage Swing (Note 10)		Full	±10	±10.5	-	V
Output Current (Note 10)	Note 3	Full	15	30	-	mA
Output Resistance		25	-	8.5	-	$\Omega$
Full Power Bandwidth (Note 6)	$V_O = \pm 10V$	25	3.2	3.8	-	MHz
Differential Gain (Note 10)	Note 4	25	-	0.03	-	%

# HA-2841

## Electrical Specifications $V_{SUPPLY} = \pm 15V$ , $R_L = 1k\Omega$ , $C_L \leq 10pF$ , Unless Otherwise Specified (Continued)

PARAMETER	TEST CONDITIONS	TEMP. (°C)	HA-2841-5			UNITS
			MIN	TYP	MAX	
Differential Phase (Note 10)	Note 4	25	-	0.03	-	Degrees
Harmonic Distortion (Note 10)	$V_O = 2V_{p-p}$ , $f = 1MHz$ , $A_V = +1$	25	-	>83	-	dBc
<b>TRANSIENT RESPONSE (Note 7)</b>						
Rise Time		25	-	3	-	ns
Overshoot		25	-	33	-	%
Slew Rate (Notes 9, 10)	$A_V = +1$	25	200	240	-	V/ $\mu s$
Settling Time	10V Step to 0.1%	25	-	90	-	ns
<b>POWER REQUIREMENTS</b>						
Supply Current (Note 10)		25	-	10	-	mA
		Full	-	10	11	mA
Power Supply Rejection Ratio (Note 10)	Note 8	Full	70	80	-	dB

### NOTES:

- Differential gain and phase are measured with a VM700A video tester, using a NTC-7 composite VITS.  $R_F = R_1 = 1k\Omega$ ,  $R_L = 700\Omega$ .
- $A_{V_{CL}} = 1000$ , Measured at unity gain crossing.
- Full Power Bandwidth guaranteed based on slew rate measurement using  $FPBW = \frac{Slew\ Rate}{2\pi V_{PEAK}}$  ( $V_{PEAK} = 10V$ ).
- Refer to Test Circuit section of data sheet.
- $V_{SUPPLY} = \pm 10V$  to  $\pm 20V$ .
- This parameter is not tested. The limits are guaranteed based on lab characterization, and reflect lot-to-lot variation.
- See "Typical Performance Curves" for more information.

## Test Circuits and Waveforms

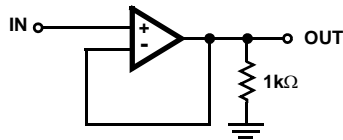

### NOTES:

- $V_S = \pm 15V$ .
- $A_V = +1$ .
- $C_L < 10pF$ .

### TEST CIRCUIT

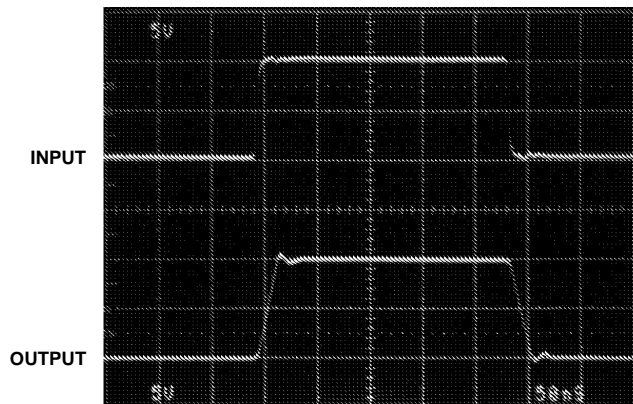

Input = 5V/Div.  
Output = 5V/Div.  
50ns/Div.

LARGE SIGNAL RESPONSE

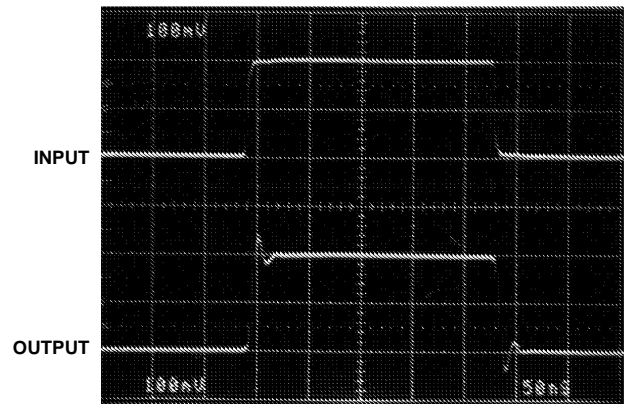

Input = 100mV/Div.  
Output = 100mV/Div.  
50ns/Div.

SMALL SIGNAL RESPONSE

**Test Circuits and Waveforms** (Continued)

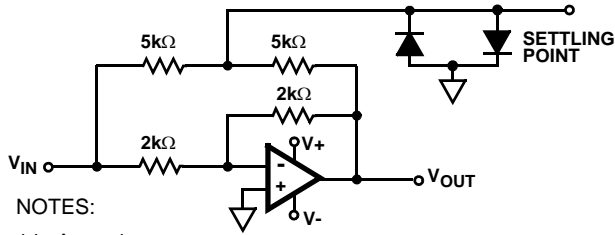

NOTES:

- 14.  $A_V = -1$ .
- 15. Load Capacitance should be less than 10pF.
- 16. Feedback and summing resistors must be matched to 0.1%.
- 17. Tektronix P6201 FET probe used at settling point.
- 18. HP5082-2810 clipping diodes recommended.

**SETTLING TIME TEST CIRCUIT**

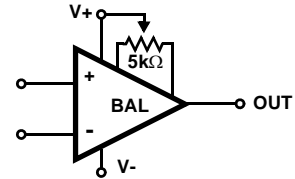

**SUGGESTED OFFSET VOLTAGE ADJUSTMENT**

**Typical Applications** (Also see Application Note AN550)

**Application 1 - High Power Amplifiers and Buffers**

High power amplifiers and buffers are in use in a wide variety of applications. Many times the “high power” capability is needed to drive large capacitive loads as well as low value resistive loads. In both cases the final driver stage is usually a power transistor of some type, but because of their inherently low gain, several stages of pre-drivers are often required. The HA-2841, with its 15mA output rating, is powerful enough to drive a power transistor without additional stages of current amplification. This capability is well demonstrated with the high power buffer circuit in Figure 1.

The HA-2841 acts as the pre-driver to the output power transistor. Together, they form a unity gain buffer with the ability to drive three 50Ω coaxial cables in parallel, each with a capacitance of 2000pF. The total combined load is 16.6Ω and 6000pF capacitance.

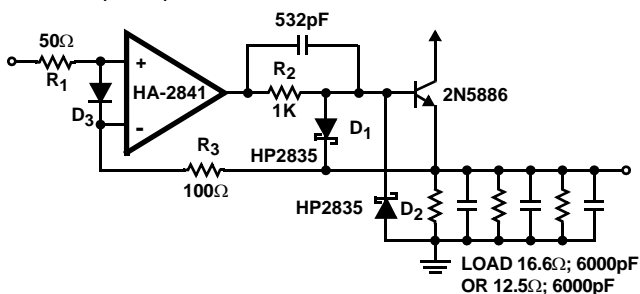

**FIGURE 1. DRIVING POWER TRANSISTORS TO GAIN ADDITIONAL CURRENT BOOSTING**

**Application 2 - Video**

One of the primary uses of the HA-2841 is in the area of video applications. These applications include signal construction, synchronization addition and removal, as well as signal modification. A wide bandwidth device such as the HA-2841 is well suited for use in this class of amplifier. This, however, is a more involved group of applications than

ordinary amplifier applications since video signals contain precise DC levels which must be retained.

The addition of a clamping circuit restores DC levels at the output of an amplifier stage. The circuit shown in Figure 2 utilizes the HA-5320 sample and hold amplifier as the DC clamp. Also shown is a 3.57MHz trap in series, which will block the color burst portion of the video signal and allow the DC level to be amplified and restored.

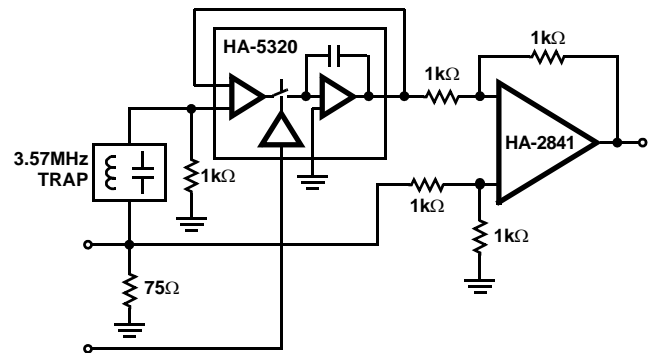

**FIGURE 2. VIDEO DC RESTORER**

**Prototyping Guidelines**

For best overall performance in any application, it is recommended that high frequency layout techniques be used. This should include:

1. Mounting the device through a ground plane.
2. Connecting unused pins (NC) to the ground plane.
3. Mounting feedback components on Teflon standoffs and/or locating these components as close to the device as possible.
4. Placing power supply decoupling capacitors from device supply pins to ground.

**Typical Performance Curves**  $T_A = 25^\circ\text{C}$ ,  $V_{\text{SUPPLY}} = \pm 15\text{V}$ ,  $R_L = 1\text{k}\Omega$ ,  $C_L < 10\text{pF}$ , Unless Otherwise Specified

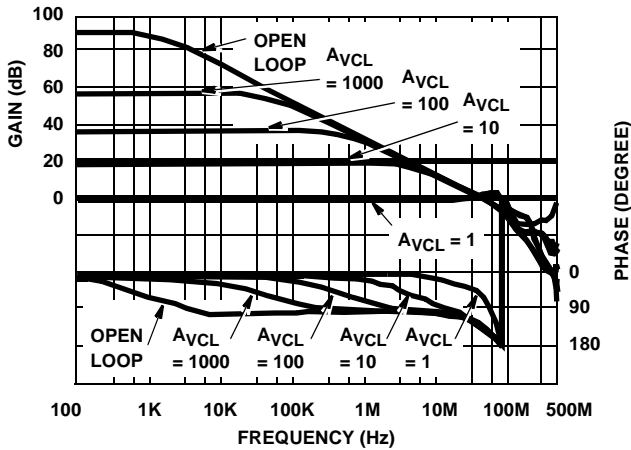

FIGURE 3. FREQUENCY RESPONSE FOR VARIOUS GAINS

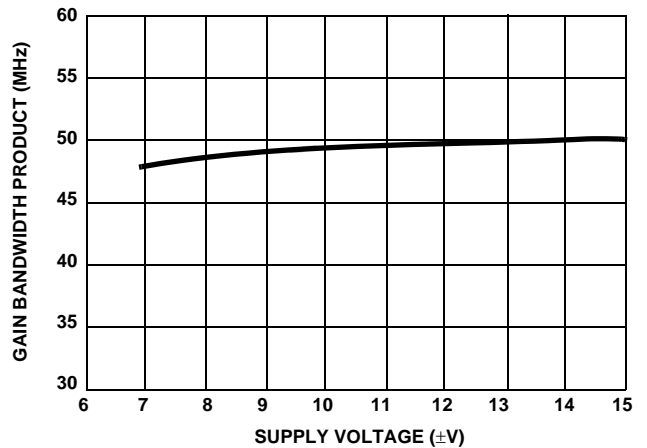

FIGURE 4. GAIN BANDWIDTH PRODUCT vs SUPPLY VOLTAGE

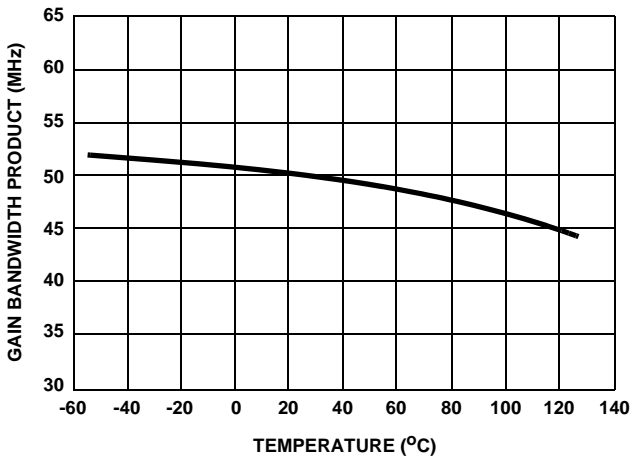

FIGURE 5. GAIN BANDWIDTH PRODUCT vs TEMPERATURE

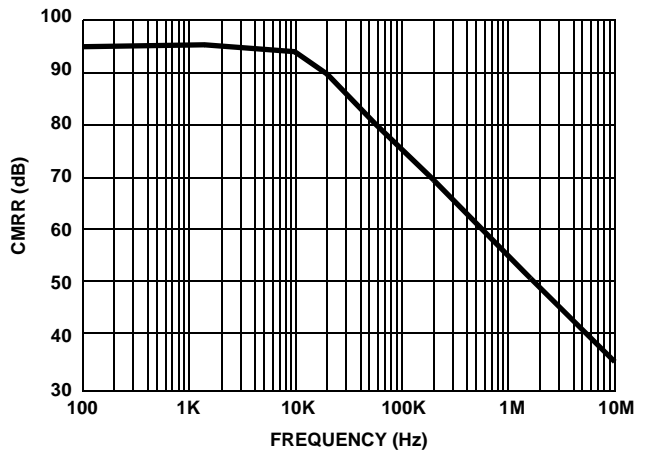

FIGURE 6. CMRR vs FREQUENCY

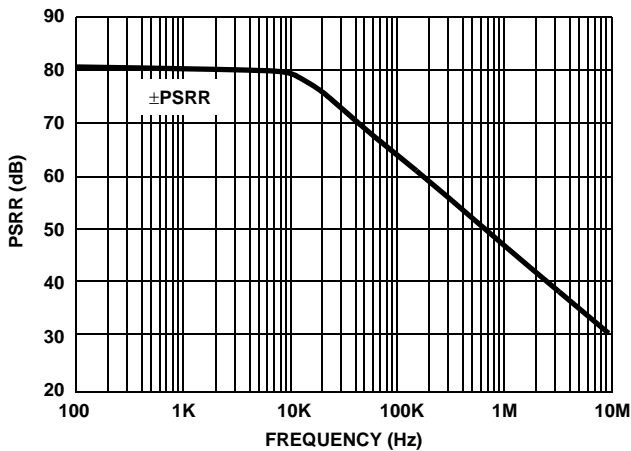

FIGURE 7. PSRR vs FREQUENCY

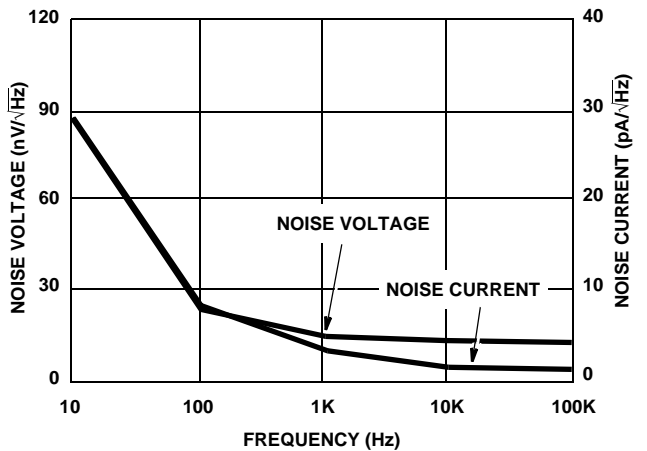

FIGURE 8. INPUT NOISE vs FREQUENCY

**Typical Performance Curves**  $T_A = 25^\circ\text{C}$ ,  $V_{\text{SUPPLY}} = \pm 15\text{V}$ ,  $R_L = 1\text{k}\Omega$ ,  $C_L < 10\text{pF}$ , Unless Otherwise Specified (Continued)

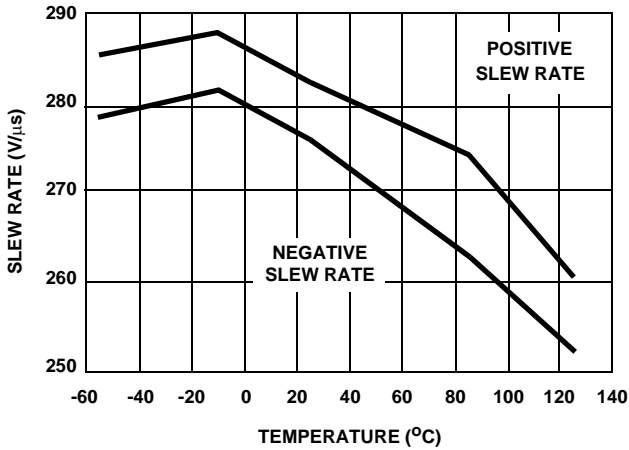

FIGURE 9. SLEW RATE vs TEMPERATURE

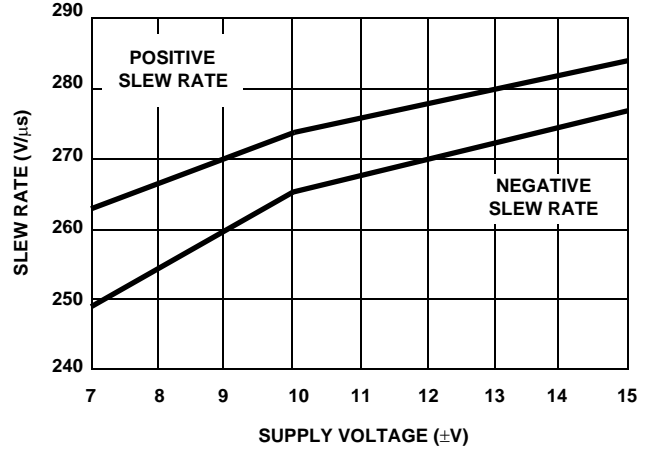

FIGURE 10. SLEW RATE vs SUPPLY VOLTAGE

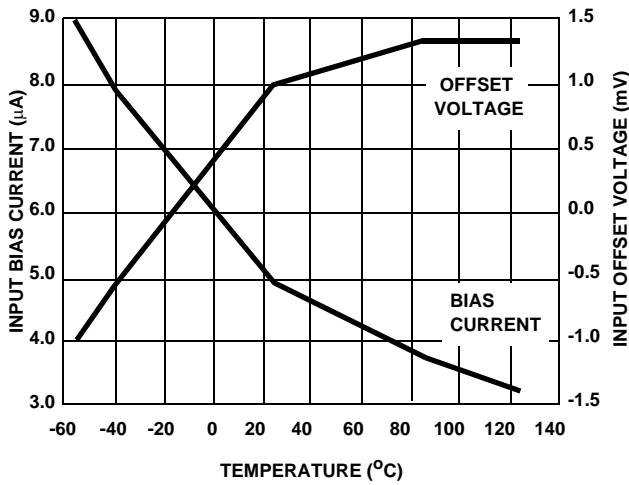

FIGURE 11. INPUT OFFSET VOLTAGE AND INPUT BIAS CURRENT vs TEMPERATURE

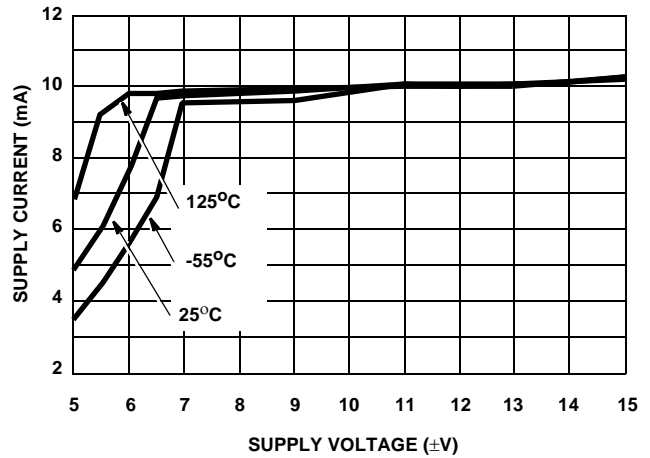

FIGURE 12. SUPPLY CURRENT vs SUPPLY VOLTAGE

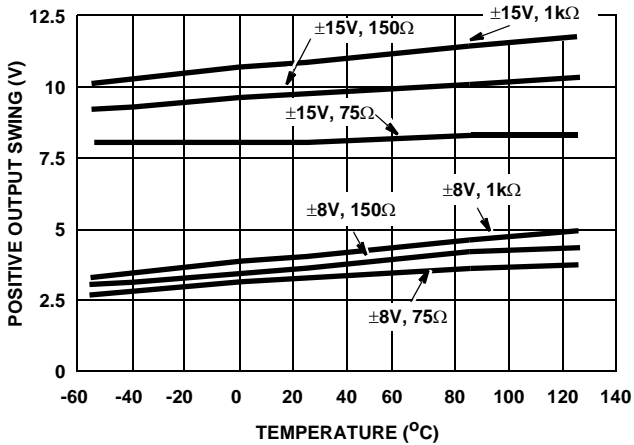

FIGURE 13. POSITIVE OUTPUT SWING vs TEMPERATURE

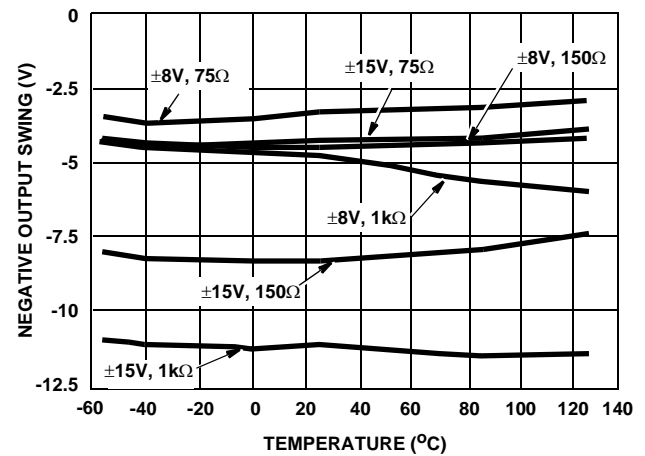

FIGURE 14. NEGATIVE OUTPUT SWING vs TEMPERATURE

**Typical Performance Curves**  $T_A = 25^\circ\text{C}$ ,  $V_{\text{SUPPLY}} = \pm 15\text{V}$ ,  $R_L = 1\text{k}\Omega$ ,  $C_L < 10\text{pF}$ , Unless Otherwise Specified (Continued)

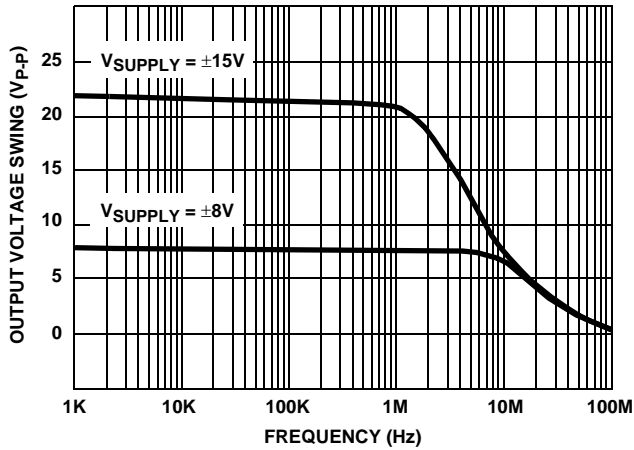

FIGURE 15. MAXIMUM UNDISTORTED OUTPUT SWING vs FREQUENCY

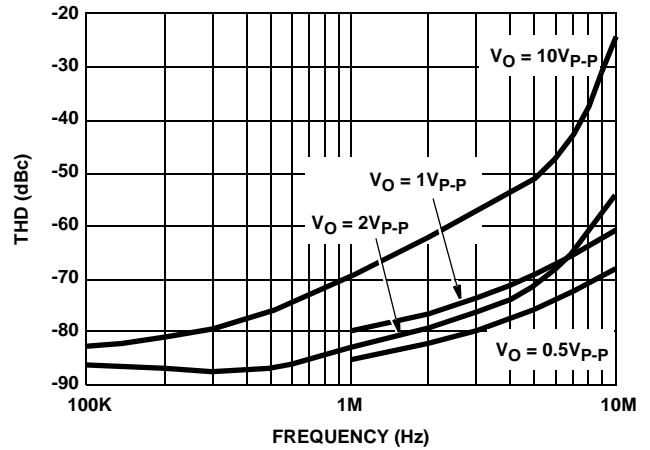

FIGURE 16. TOTAL HARMONIC DISTORTION vs FREQUENCY

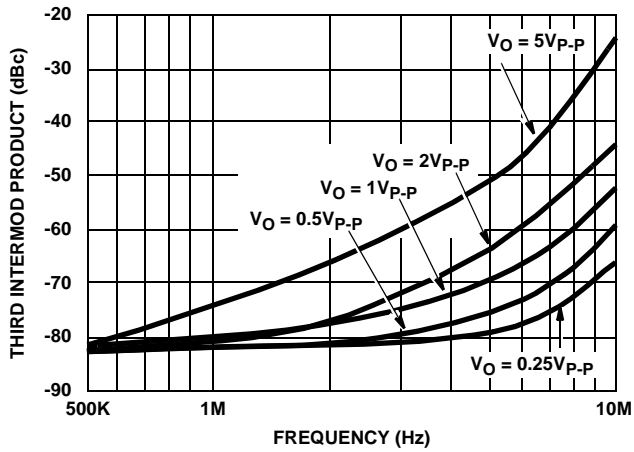

FIGURE 17. INTERMODULATION DISTORTION vs FREQUENCY (TWO TONE)

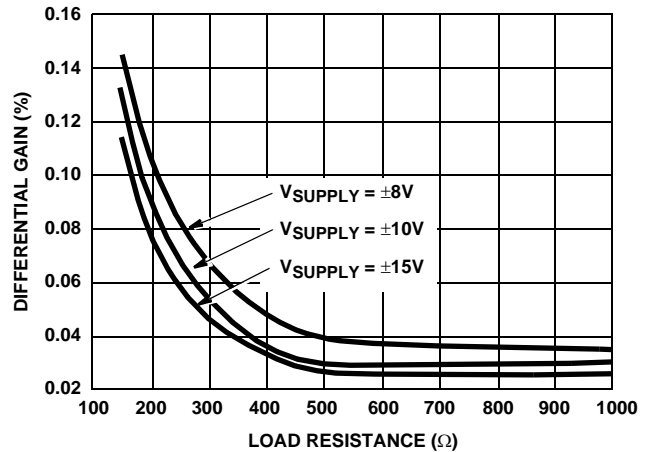

FIGURE 18. DIFFERENTIAL GAIN vs LOAD RESISTANCE

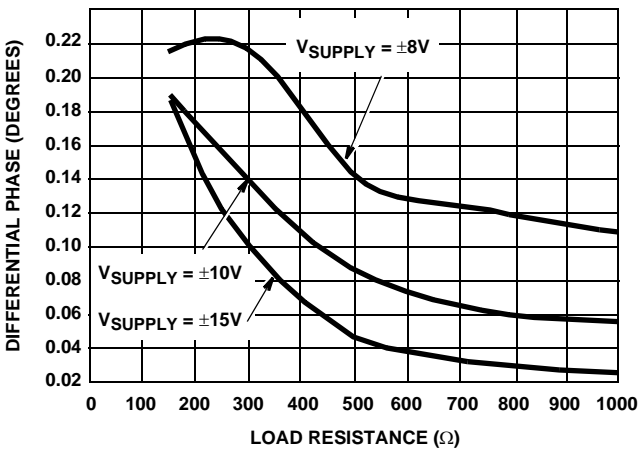

FIGURE 19. DIFFERENTIAL PHASE vs LOAD RESISTANCE

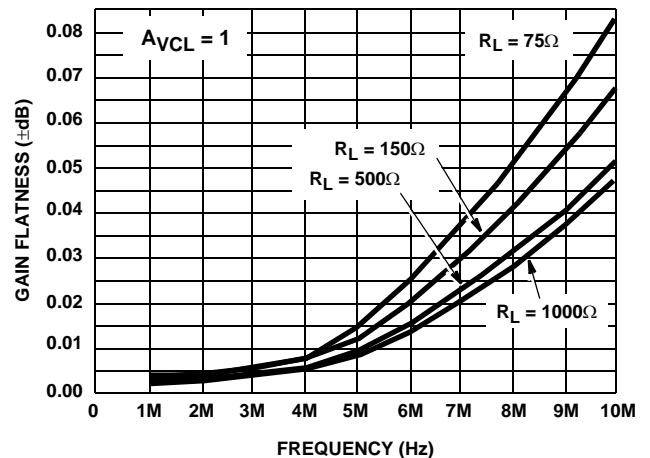

FIGURE 20. GAIN FLATNESS vs FREQUENCY

**Die Characteristics**

**DIE DIMENSIONS:**

77 mils x 81 mils x 19 mils  
 1960 $\mu$ m x 2060 $\mu$ m x 483 $\mu$ m

**METALLIZATION:**

Type: Aluminum, 1% Copper  
 Thickness: 16k $\text{\AA}$   $\pm$  2k $\text{\AA}$

**PASSIVATION:**

Type: Nitride over Silox  
 Silox Thickness: 12k $\text{\AA}$   $\pm$  2k $\text{\AA}$   
 Nitride thickness: 3.5k $\text{\AA}$   $\pm$  1k $\text{\AA}$

**SUBSTRATE POTENTIAL (Powered Up):**

V-

**TRANSISTOR COUNT:**

43

**PROCESS:**

High Frequency Bipolar Dielectric Isolation

**Metallization Mask Layout**

HA-2841

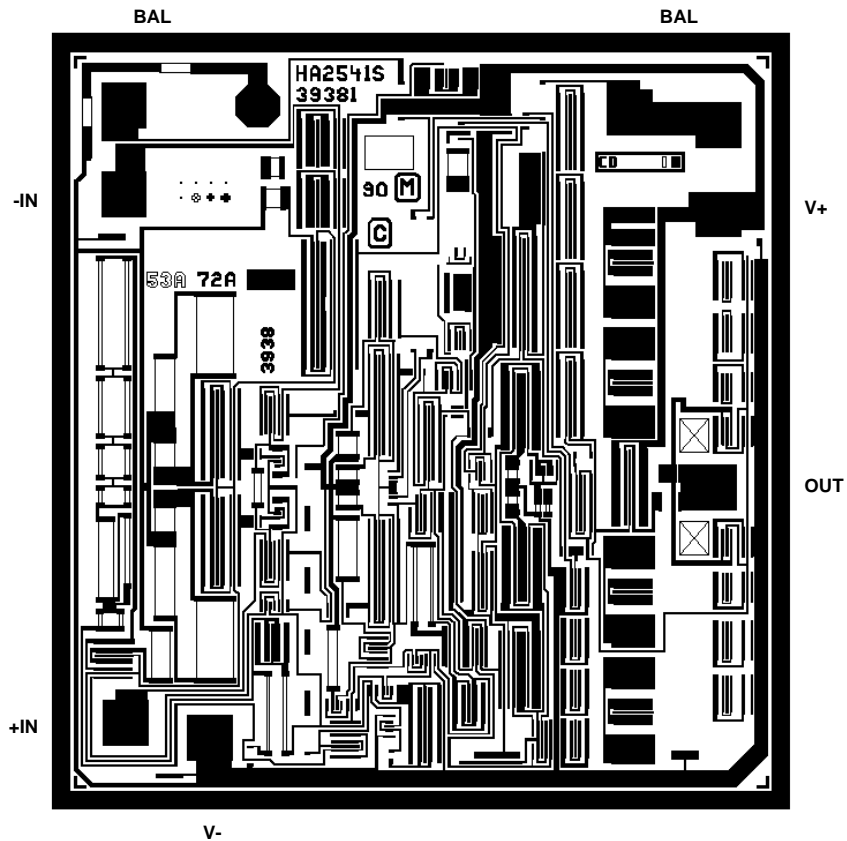

All Intersil U.S. products are manufactured, assembled and tested utilizing ISO9000 quality systems.  
 Intersil Corporation's quality certifications can be viewed at [www.intersil.com/design/quality](http://www.intersil.com/design/quality)

*Intersil products are sold by description only. Intersil Corporation reserves the right to make changes in circuit design, software and/or specifications at any time without notice. Accordingly, the reader is cautioned to verify that data sheets are current before placing orders. Information furnished by Intersil is believed to be accurate and reliable. However, no responsibility is assumed by Intersil or its subsidiaries for its use; nor for any infringements of patents or other rights of third parties which may result from its use. No license is granted by implication or otherwise under any patent or patent rights of Intersil or its subsidiaries.*

For information regarding Intersil Corporation and its products, see [www.intersil.com](http://www.intersil.com)