

4mm Pitch Single Side Card Edge Connector

CR23 Series

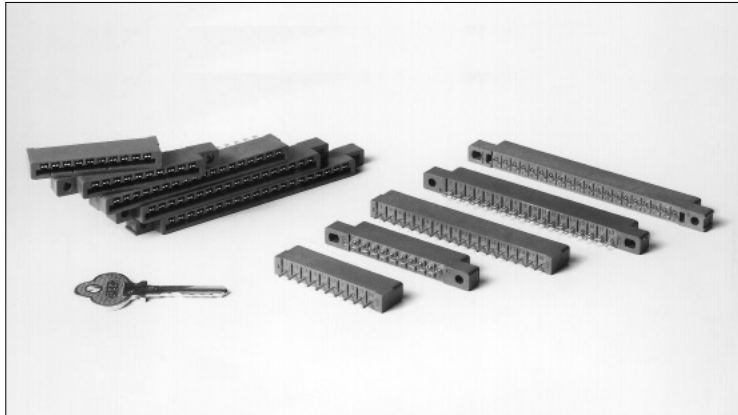
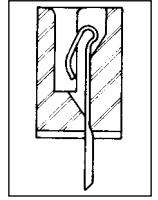

■ Features

1. 4mm pitch contact

2. Variation in number of contacts

6, 10, 14, 18, 20, and 22 contacts are available.

3. Connection method

Eyelet and through hole types are available.

4. Prevents mis-insertion in the board

Using the polarizing key prevents mis-insertion in the board.

■ Product Specifications

Rating	Current rating: 3A Voltage rating: 600V AC	Operating Temperature Range : -30°C to +85°C (Note 1) Operating Humidity Range : 40% to 80%	Storage Temperature Range : -10 to +60°C (Note 2) Storage Humidity Range : 40 to 70% (Note 2)
--------	---	--	--

Item	Specification	Condition
1. Insulation Resistance	5000M ohms	500V DC
2. Withstanding Voltage	No flashover or insulation breakdown.	1800V AC/1 minute
3. Contact Resistance	15m ohms max.	1A
4. Vibration	No electrical discontinuity of 10 μ s or more	Frequency: 10 to 55 Hz, single amplitude of 0.75 mm, 2 hours in each of the 3 directions.
5. Humidity (Steady state)	Insulation resistance: 5000M min.	96 hours at temperature of 40°C and humidity of 90% to 95%
6. Temperature Cycle	No damage, cracks, or parts looseness.	(-55°C : 30 minutes → 15 to 35°C : 5 minutes max. → 85°C : 30 minutes → 15 to 35°C : 5 minutes max.) 5 cycles
7. Durability (Mating/un-mating)	Contact resistance: 30m ohms max.	500 cycles
8. Resistance to Soldering heat	No deformation of components affecting performance.	Manual soldering: 300°C for 3 seconds

Note 1: Includes temperature rise caused by current flow.

Note 2: The term "storage" refers to products stored for long period of time prior to mounting and use. Operating Temperature Range and Humidity range covers non conducting condition of installed connectors in storage, shipment or during transportation.

■ Material

Parts	Material	Finish	Remarks
Insulator	Polycarbonate	Blue	UL94V-0
Contact	Copper alloy	Tin plated or gold plated	_____

■ Ordering information

CR23 **A** - **6** **S** **A** - **4** **DS**
 ① ② ③ ④ ⑤ ⑥ ⑦

① Series Name : CR23	⑤ A: Gold plating B: Tin plating
② Mold Type : A: Without mounting hole Blank: With Mounting hole	⑥ Contact pitch: 4mm
③ Number of contacts: 6, 10, 14, 18, 22	⑦ Contact type
④ Contact alignment : Single side	DS: Through hole type E : Eyelet type

■Connector Type

6,10,14,18,20,22 contacts

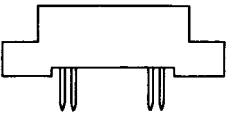
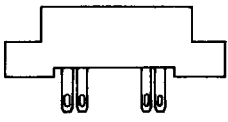
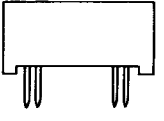
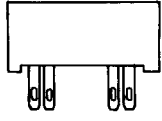
		Through hole	Eyelet (E)
Tin plated Gold plated	With mounting hole		
	Without mounting hole		

■Contact Type

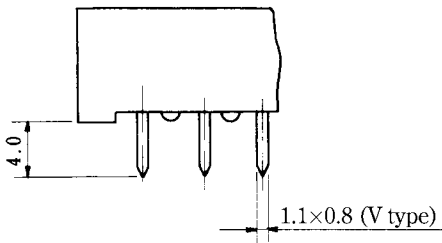

(1) Through hole

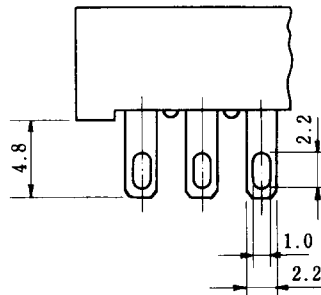

(2) Eyelet (E)

■With Mounting Hole Type

●Through hole Type

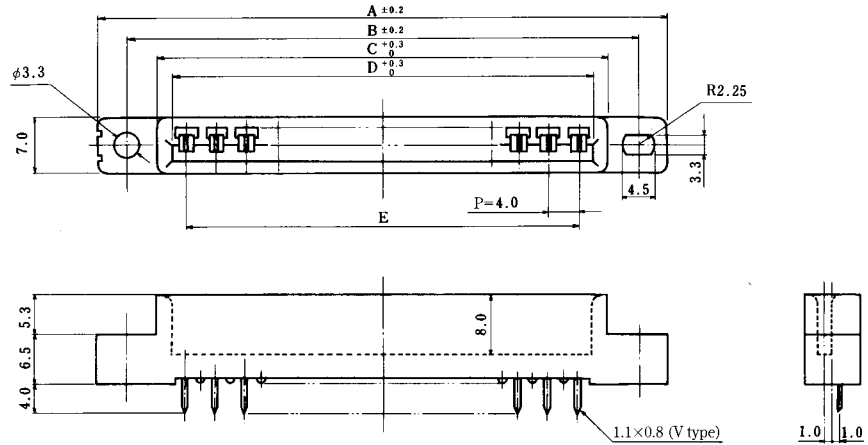
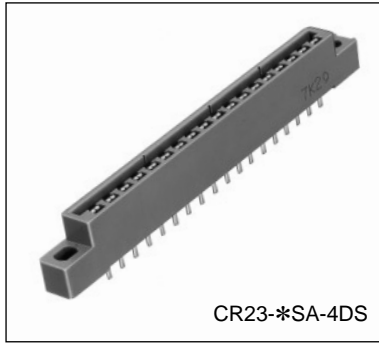

●Eyelet Type

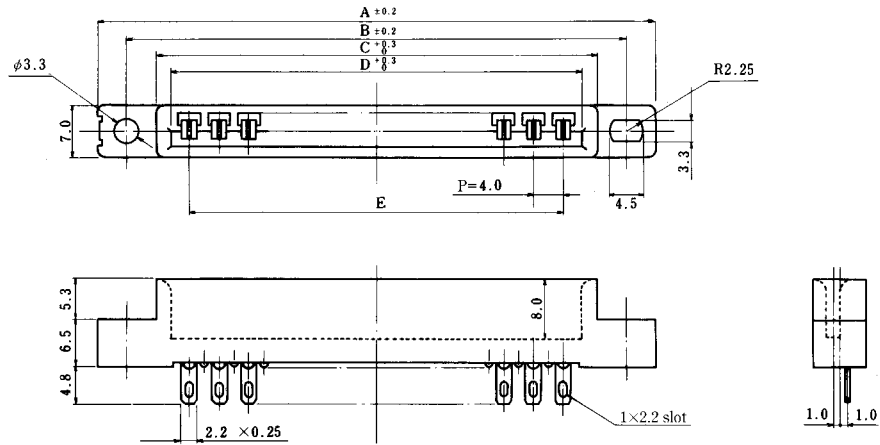
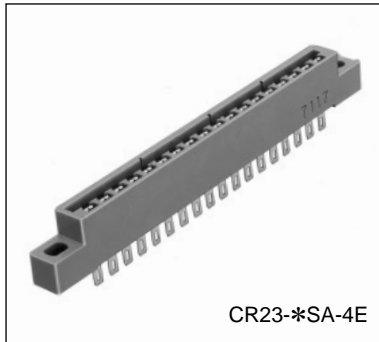

Unit: mm

Part Number	CL No.	Number of Contacts	A	B	C	D	E
CR23-6SA-4DS	523-0025-6	6	45	37	30	25.5	20
CR23-6SA-4E	523-0001-8						
CR23-10SA-4DS	523-0029-7	10	61	53	46	41.5	36
CR23-10SA-4E	523-0005-9						
CR23-10SB-4E	523-0007-4						
CR23-14SA-4DS	523-0033-4	14	75	67	60	57.5	52
CR23-14SA-4E	523-0009-0						
CR23-14SB-4E	523-0011-1						
CR23-18SA-4DS	523-0037-5	18	92	84	77	73.5	68
CR23-18SA-4E	523-0013-7						
CR23-22SA-4DS	523-0045-3	22	109	101	94	89.5	84
CR23-22SA-4E	523-0021-5						

■Without Mounting Hole Type

●Through hole Type

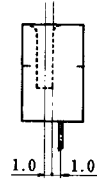
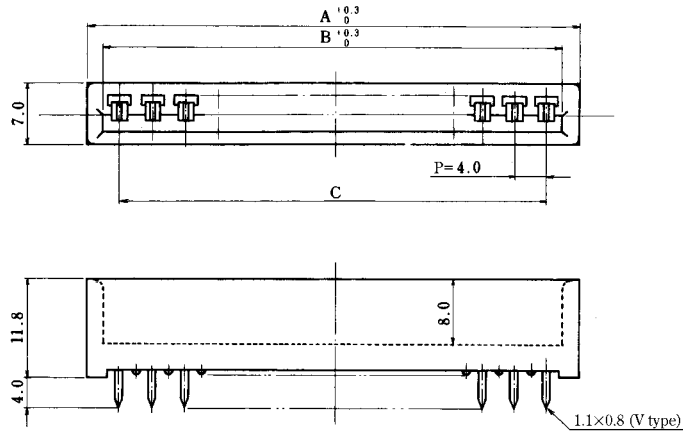
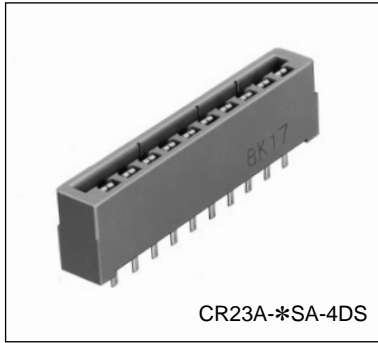

●Eyelet Type

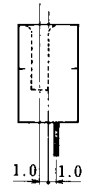
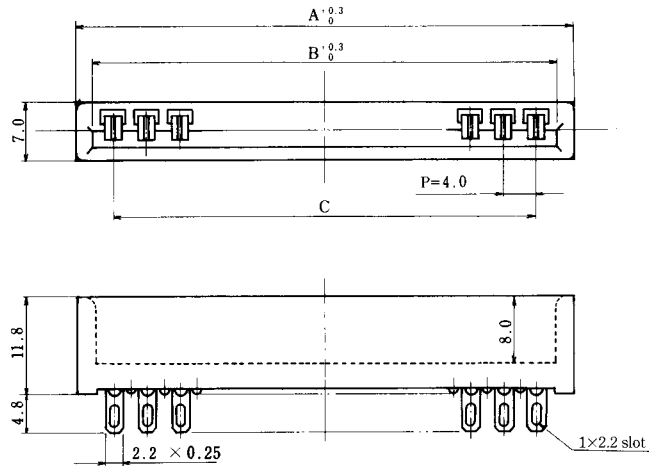
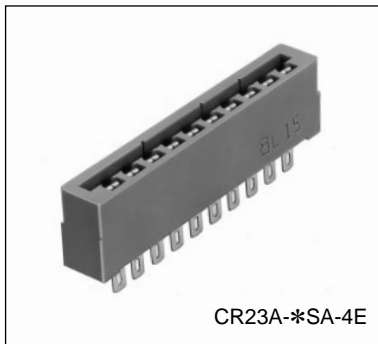

Unit: mm

Part Number	CL No.	Number of Contacts	A	B	C
CR23A-6SA-4DS	523-0026-9	6	30	25.5	20
CR23A-6SA-4E	523-0002-0				
CR23A-10SA-4DS	523-0030-6	10	46	41.5	36
CR23A-10SB-4DS	523-0032-1				
CR23A-10SA-4E	523-0006-1				
CR23A-10SB-4E	523-0008-7				
CR23A-14SA-4DS	523-0034-7	14	60	57.5	52
CR23A-14SB-4DS	523-0036-2				
CR23A-14SA-4E	523-0010-9				
CR23A-14SB-4E	523-0012-4				
CR23A-18SA-4E	523-0014-0	18	77	73.5	68
CR23A-22SB-4DS	523-0048-1	22	94	89.5	84

◆PCB Dimensions

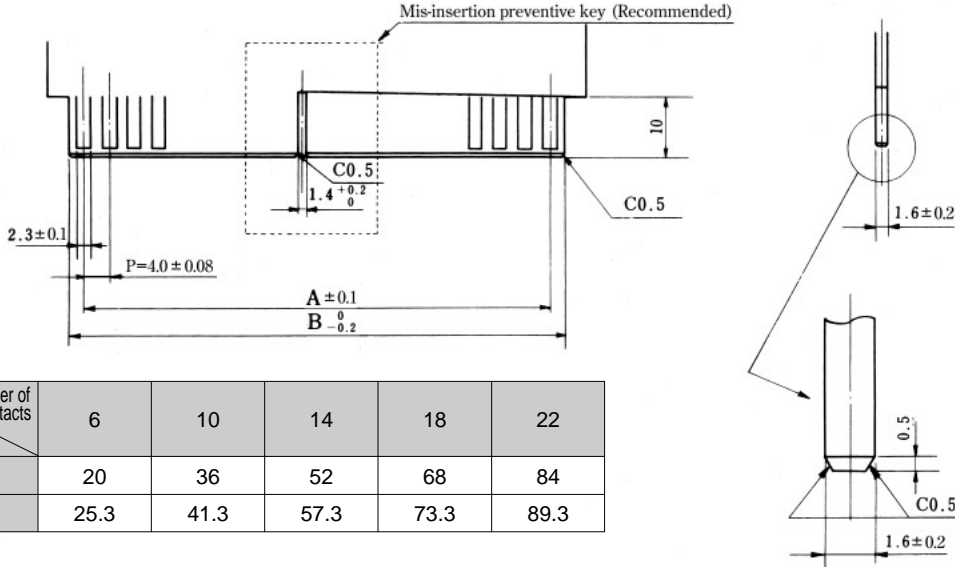

■Polarizing Key

Part Number	CL No.	Material	Finish
CR7C-GPIN	507-0055-8	Polyacetal	White
HIF5B-GPIN	564-0052-4	PBT	Beige

Note: Using the polarizing key prevents mis-insertion in the printed board.
To use the polarizing key, insert the polarizing key so as to hit the mold bottom.

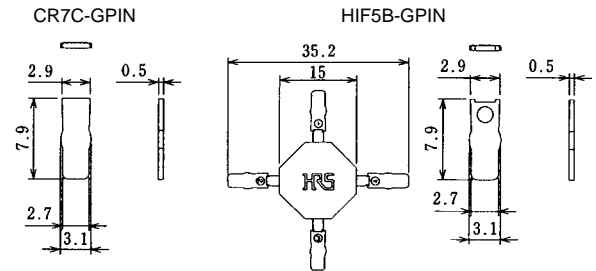

◆PCB mounting pattern

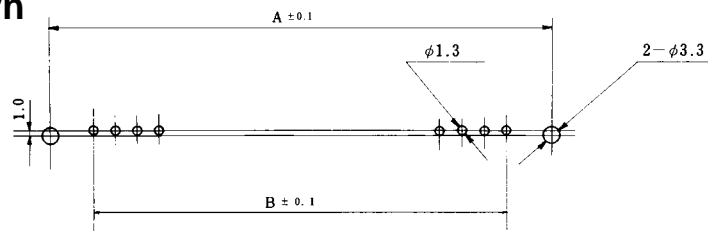

Number of Contacts	6	10	14	18	22
Size					
A	37	53	67	84	101
B	20	36	52	68	84

◆Contact No. Alignment List



Note 1: If alphabetic symbols are utilized, following 8 alphabetic characters are not used.
G, I, O, Q, g, i, o, q

Note 2: The above pattern is viewed from the Contact (connection) side.