

LDO Regulators with Watch-Dog Timer

500mA Output LDO Regulators with Voltage Detector and Watchdog Timer

BD3020HFP BD3021HFP

General Description

BD3020HFP BD3021HFP is a regulator IC with integrated WDT (Watch Dog Timer), high output voltage accuracy $\pm 2.0\%$ and $80\ \mu\text{A}$ (Typ) low circuit current consumption. These are supports usage of low ESR ceramic capacitor for output stability. The reset detection voltage can be adjusted by connecting resistors on the Vs terminal (BD3020HFP). They can be a stable power supply for any applications while detecting malfunction of microcontrollers.

Features

- Integrated WDT Reset Circuit
[BD3020HFP]: Adjustable Detection Voltage through Vs pin
[BD3021HFP]: WDT Can be Switched ON / OFF by Using INH Pin
- Low saturation voltage by using PMOS output transistor
- VCC Max Voltage: 50 V
- Integrated Over Current Protection and Thermal Shut Down
- HRP7 package

Key specification

- Low Circuit Current: $80\ \mu\text{A}$ (Typ)
- Output Voltage: $5.0\ \text{V}$ (Typ)
- Output Current: $500\ \text{mA}$
- High Output Voltage Accuracy: $\pm 2\%$
- Low ESR ceramic capacitor can be used as output capacitor

Package

- W (Typ) × D (Typ) × H (Max)
 ■ HRP7 $9.395\ \text{mm} \times 10.540\ \text{mm} \times 2.005\ \text{mm}$



Figure 1. Package Outlook

Applications

- Automotive (body, audio system, navigation system, etc.)

Typical Application Circuits

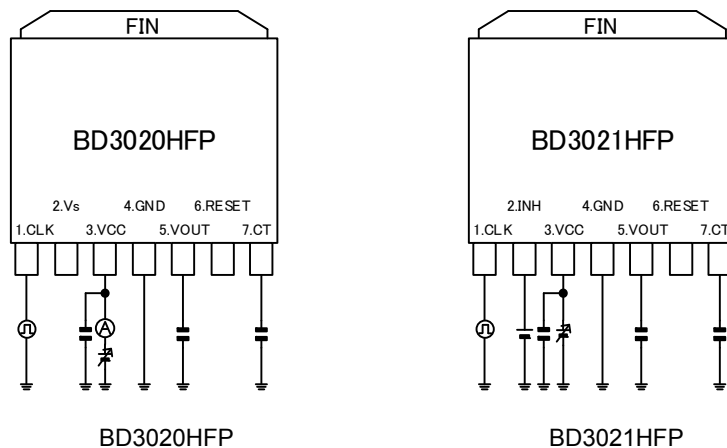
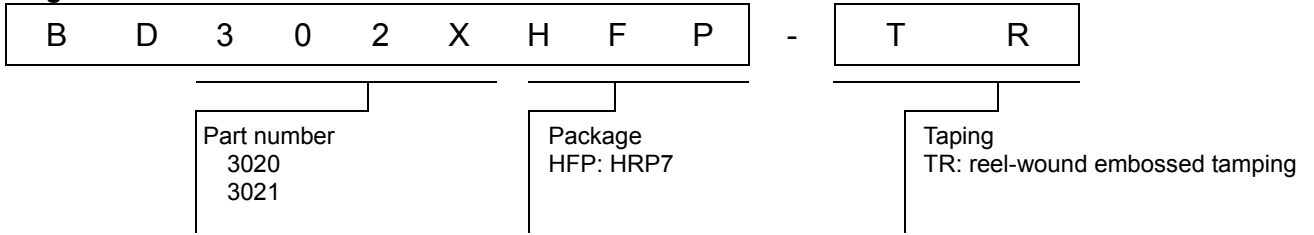

Figure 2. Typical Application Circuits

Ordering Information



Pin Configuration

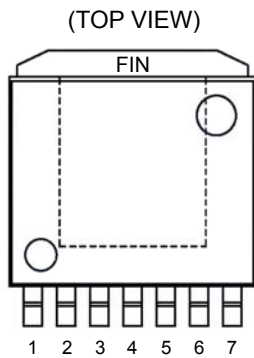

Figure 3. Pin Configuration

Pin Description

Pin No.	Pin Name	Function
1	CLK	Clock Input from Microcontroller
2	Vs (BD3020HFP)	Reset Detection Voltage Set Pin
	INH (BD3021HFP)	WDT ON/OFF Function Pin
3	VCC	Power Supply Pin
4	GND	GND
5	VOUT	Voltage Output Pin
6	RESET	Reset Output Pin
7	CT	External Capacitance for Reset Output Delay Time, WDT Monitor Time Setting Connection Pin
Fin	GND	GND

Block Diagram

<BD3020HFP>

<BD3021HFP>

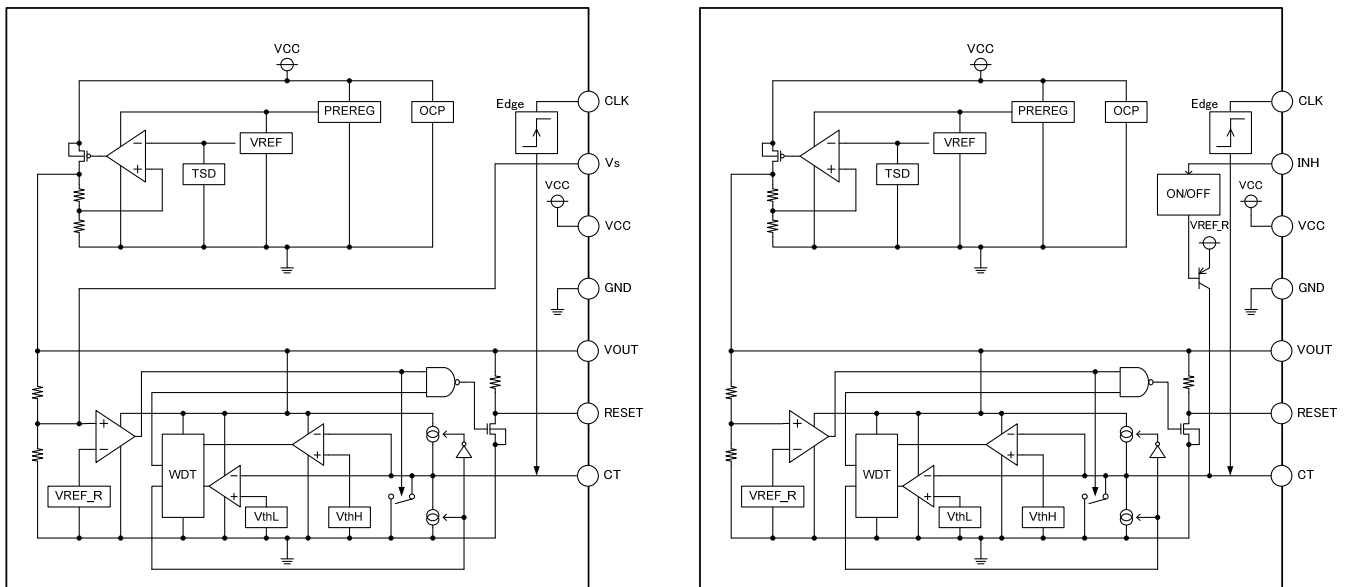

Figure 4. Block Diagrams

Absolute Maximum Ratings (Ta = 25 °C)

Parameter	Symbol	Ratings	Unit
Supply Voltage ⁽¹⁾	V _{CC}	-0.3 to +50.0	V
Vs pin Voltage (BD3020HFP)	V _S	-0.3 to +15.0	V
INH pin Voltage (BD3021HFP)	V _{INH}	-0.3 to +15.0	V
Regulator Output pin Voltage	V _{OUT}	-0.3 to +15.0	V
Reset Output pin Voltage	V _{RESET}	-0.3 to +15.0	V
Watchdog Input pin Voltage	V _{CLK}	-0.3 to +15.0	V
Reset Delay Setting pin Voltage	V _{CT}	-0.3 to +15.0	V
Power Dissipation ⁽²⁾	P _d	1.6	W
Operating Temperature Range	T _{opr}	-40 to +125	°C
Storage Temperature Range	T _{stg}	-55 to +150	°C
Maximum Junction Temperature	T _{jmax}	150	°C

(1) P_d should not be exceeded.

(2) HRP7 mounted on 70.0 mm × 70.0 mm × 1.6 mm Glass-Epoxy PCB. If Ta ≥ 25 °C, reduce by 12.8 mW / °C.

(1-layer PCB: Copper foil area on the reverse side of PCB: 0 mm × 0 mm)

Caution: Operating the IC over the absolute maximum ratings may damage the IC. The damage can either be a short circuit between pins or an open circuit between pins and the internal circuitry. Therefore, it is important to consider circuit protection measures, such as adding a fuse, in case the IC is operated over the absolute maximum ratings.

Operating Conditions (-40°C ≤ Ta ≤ +125 °C)

Parameter	Symbol	Min	Max	Unit
Supply Voltage ⁽³⁾	V _{CC}	5.6	36.0	V
Output Current	I _o	0	500	mA

(3) For the output voltage, consider the voltage drop (dropout voltage) due to the output current.

Electrical Characteristics (Unless otherwise specified, $-40^{\circ}\text{C} \leq T_a \leq +125^{\circ}\text{C}$, $V_{CC} = 13.5\text{ V}$, $V_{CLK} = \text{GND}$)

Parameter	Symbol	Limit			Unit	Conditions
		Min	Typ	Max		
Overall Device						
Bias Current 1	I _{cc1}	—	80	130	μA	I _o = 0 mA
Bias Current 2	I _{cc2}	—	150	300	μA	I _o = 50 mA (T _a = 25 °C)
Regulator						
Output Voltage	V _{OUT}	4.90	5.00	5.10	V	I _o = 200 mA
Line Regulation	Line.Reg	—	5	35	mV	5.6 V ≤ V _{CC} ≤ 36 V
Load Regulation	Load.Reg	—	30	70	mV	5 mA ≤ I _o ≤ 200 mA
Dropout Voltage	ΔV _d	—	0.3	0.6	V	V _{CC} = 4.75 V, I _o = 200 mA
Ripple Rejection	R.R.	45	55	—	dB	f = 120Hz, e _{in} = 1 V _{rms} , I _o = 100 mA
Reset						
Detection Voltage (BD3020HFP)	V _{det}	4.02	4.10	4.18	V	
Detection Voltage (BD3021HFP)	V _{det}	4.40	4.50	4.60	V	
Hysteresis Width	V _{HS}	50	100	150	mV	
Output Delay Time Low→High (Power On Reset Time)	t _{dLH}	1.1	1.9	2.7	ms	V _{CC} = V _{det} ±0.5 V (V _{CC} = V _{OUT}) INH = open ⁽¹⁾ , C _{CT} = 0.01 μF
Output Delay Time High→Low	t _{dHL}	—	100	300	μs	V _{CC} = V _{det} ±0.5 V (V _{CC} = V _{OUT}) INH = open ⁽¹⁾ , C _{CT} = 0.01 μF
RESET Discharge Current	I _{RESET}	0.2	—	—	mA	V _{CC} = 1.5 V, V _{RESET} = 0.5 V (V _{CC} = V _{OUT})
CT Discharge Current	I _{ct}	0.1	—	—	mA	V _{CC} = 1.5 V, V _{CT} = 0.5 V (V _{CC} = V _{OUT})
Low Output Voltage	V _{RST}	—	0.1	0.2	V	V _{OUT} = 4.0 V
Min Operating Voltage	V _{OPL}	1.5	—	—	V	

(1) BD3021HFP only

Electrical Characteristics (Unless otherwise specified, $-40^{\circ}\text{C} \leq T_a \leq +125^{\circ}\text{C}$, $V_{CC} = 13.5\text{ V}$, $V_{CLK} = \text{GND}$)

Parameter	Symbol	Limit			Unit	Conditions
		Min	Typ	Max		
Watchdog timer						
CT Switching Threshold Voltage High	V _{thH}	1.08	1.15	1.25	V	WDT ON ⁽¹⁾ , INH = open ⁽¹⁾
CT Switching Threshold Voltage Low	V _{thL}	0.13	0.15	0.17	V	WDT ON ⁽¹⁾ , INH = open ⁽¹⁾
WDT Charge Current	I _{ctc}	3.5	6.0	8.5	μA	WDT ON ⁽¹⁾ , INH = open ⁽¹⁾ V _{CT} = 0 V
WDT Discharge Current	I _{ctd}	1.2	2.0	2.8	μA	WDT ON ⁽¹⁾ , INH = open ⁽¹⁾ V _{CT} = 1.3 V
Watchdog Monitor Time Low	t _{WH}	3.0	5.0	7.0	ms	WDT ON ⁽¹⁾ , INH = open ⁽¹⁾ , C _{CT} = 0.01 μF (Ceramic Capacitor) ⁽²⁾
Watchdog Reset Time	t _{WL}	1.0	1.7	2.4	ms	
CLK Input Pulse Width	t _{WCLK}	500	-	-	ns	
INH*						
WDT OFF Threshold Voltage	V _{HINH}	V _{OUT} × 0.8	-	V _{OUT}	V	
WDT ON Threshold Voltage	V _{LINH}	0	-	V _{OUT} × 0.3	V	INH is pulled down inside the IC when INH open.
INH Input current	I _{INH}	-	10	20	μA	V _{INH} = 5 V

(1) BD3021HFP only

(2) Characteristics of ceramic capacitor not considered.

Reference data

Unless otherwise specified, $T_a = 25\text{ }^\circ\text{C}$, $V_{CC} = 13.5\text{ V}$, $V_{CLK} = \text{GND}$

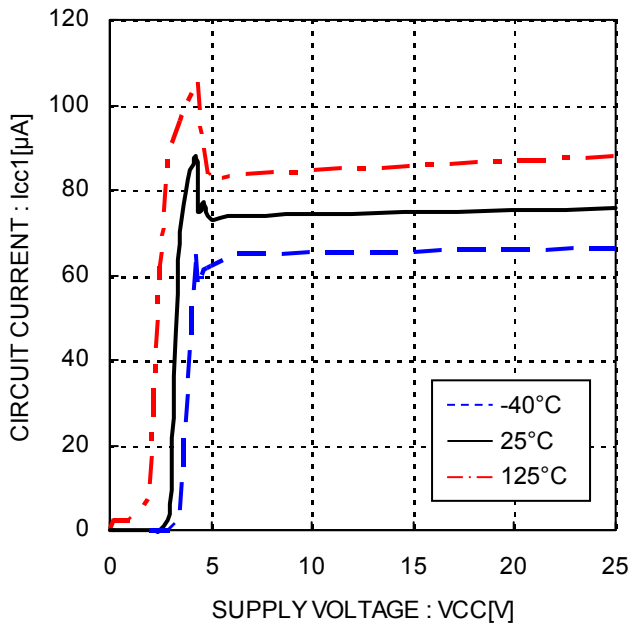

Figure 5. Circuit Current 1

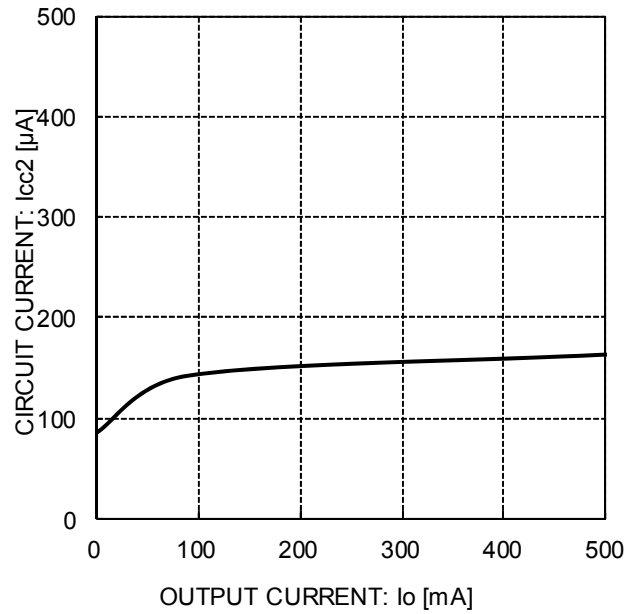

Figure 6. Circuit Current 2

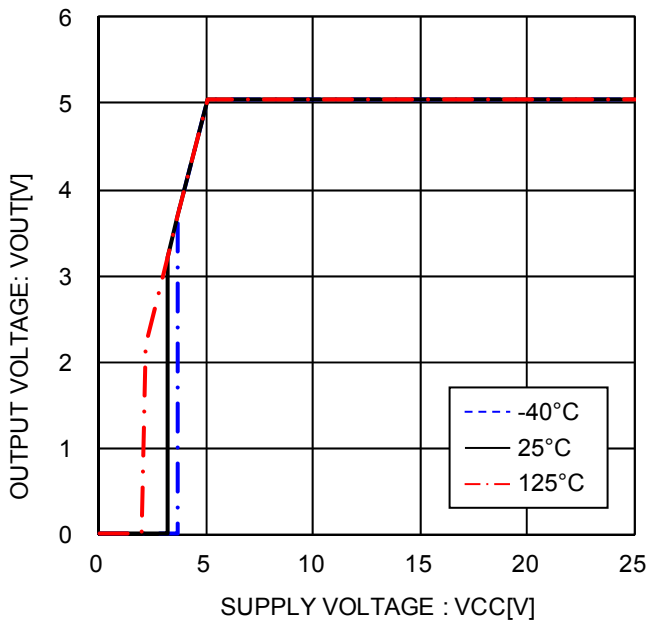

Figure 7. Input Stability

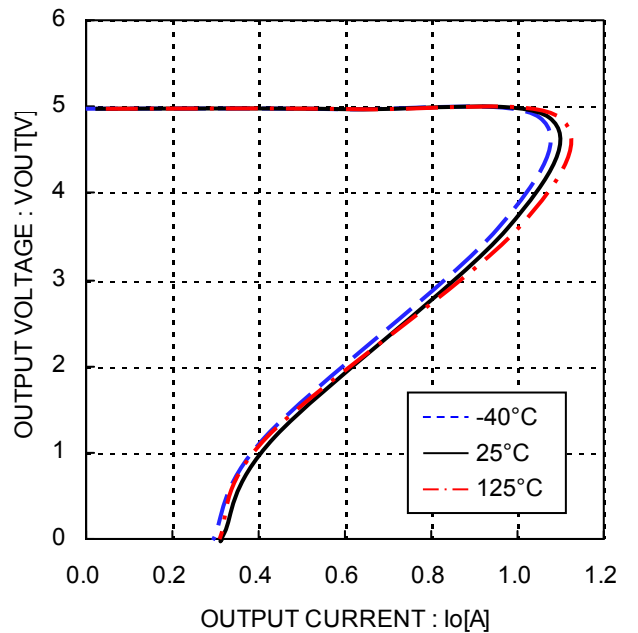

Figure 8. Load Stability

Reference data

Unless otherwise specified, $T_a = 25\text{ }^\circ\text{C}$, $V_{CC} = 13.5\text{ V}$, $V_{CLK} = \text{GND}$

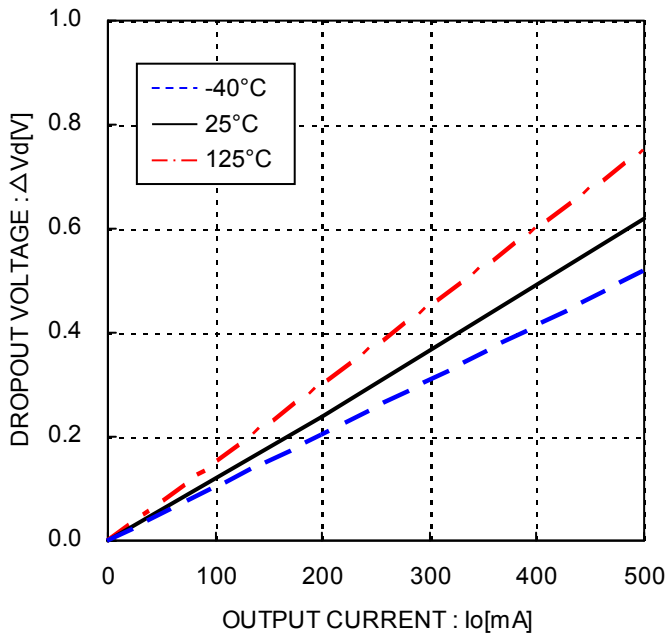

Figure 9. Dropout Voltage

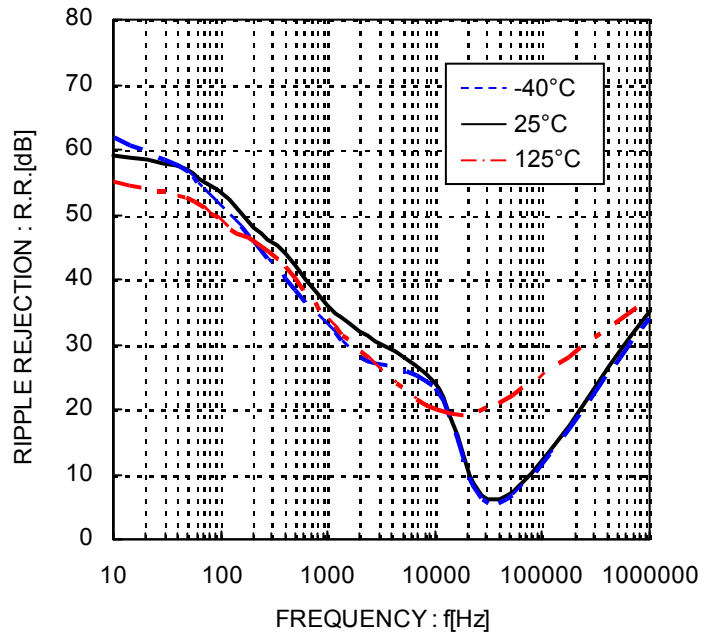

Figure 10. Ripple Rejection

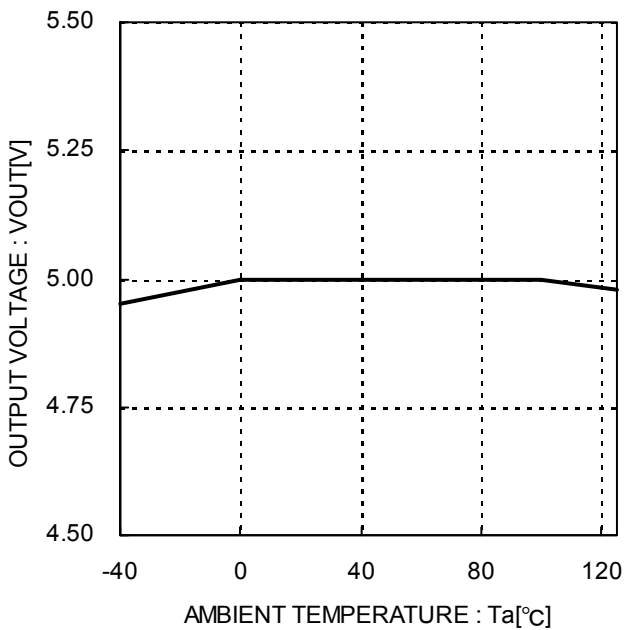

Figure 11. Output Voltage Temperature Characteristics

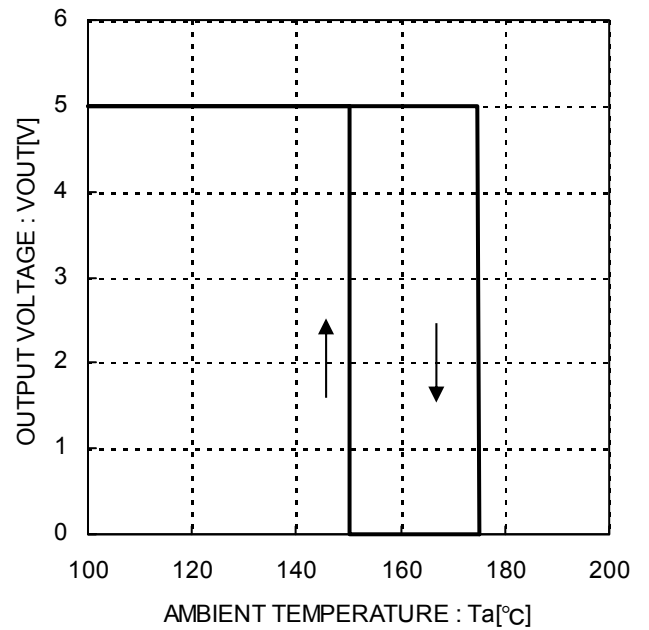

Figure 12. Thermal Shutdown Circuit Characteristics

Reference data

Unless otherwise specified, $T_a = 25\text{ }^\circ\text{C}$, $V_{CC} = 13.5\text{ V}$, $V_{CLK} = \text{GND}$

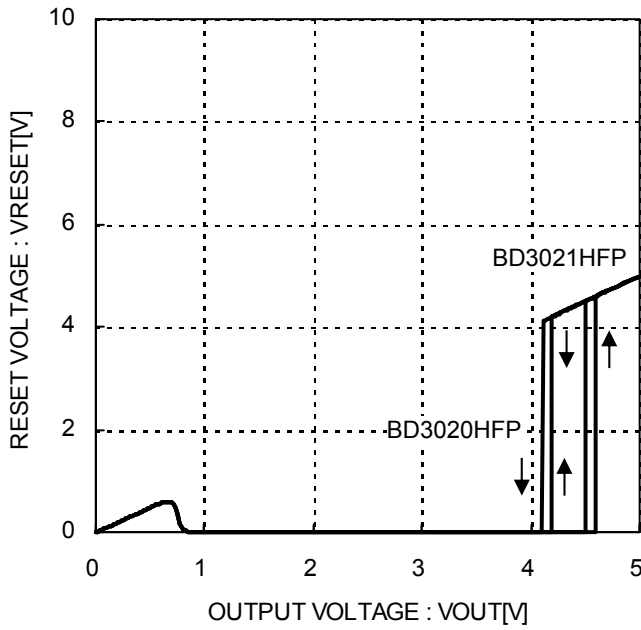

Figure 13. Detection Voltage ($V_{CC}=V_{OUT}$)

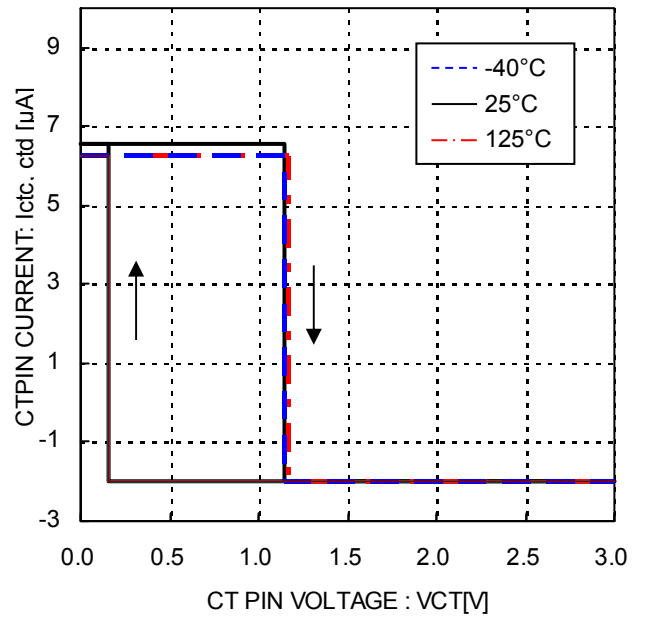

Figure 14. CT Pin Charge / Discharge Current ($V_{CC}=5\text{ V}$)

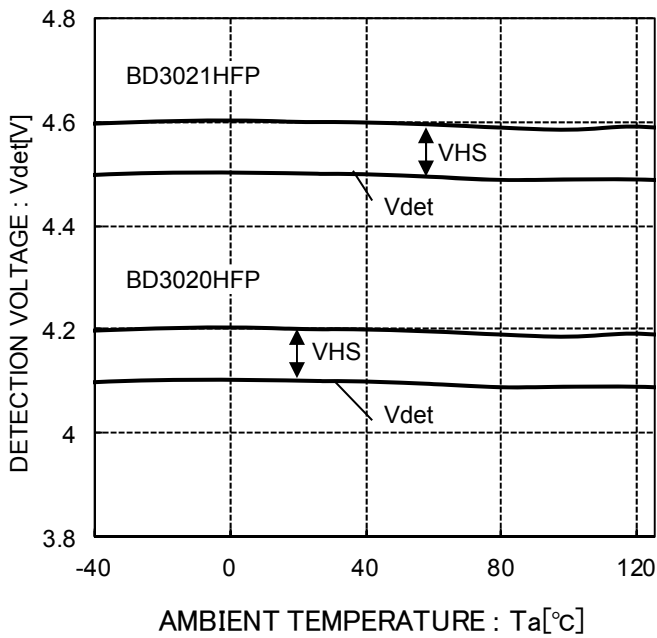

Figure 15. Reset Detection Voltage vs. Temperature

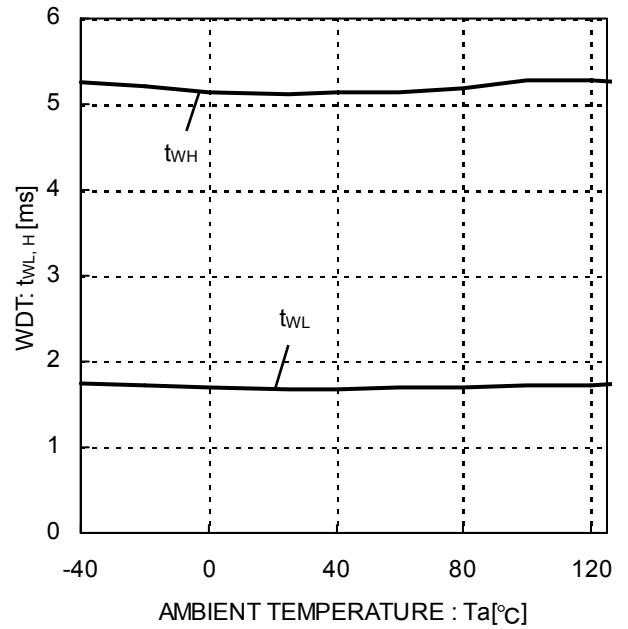
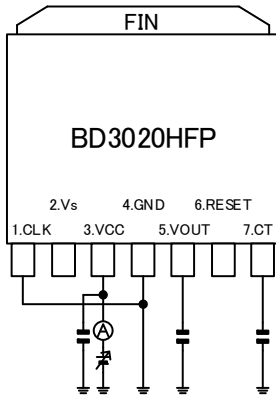
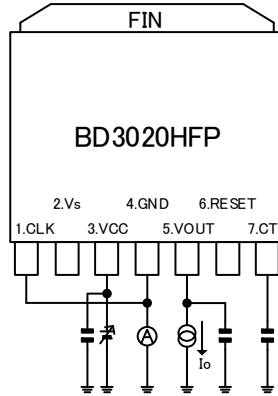

Figure 16. WDT Time vs. Temperature ($C_{CT}=0.01\mu\text{F}$)

Measurement Circuits (BD3020HFP)



Measurement setup for Figure 5.



Measurement setup for Figure 6.

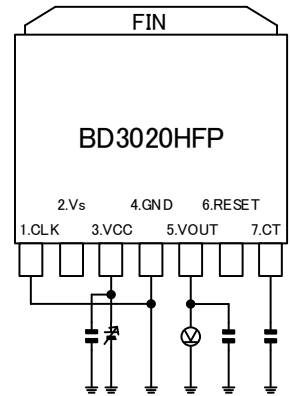

Measurement setup for Figure 7, 11, 12.

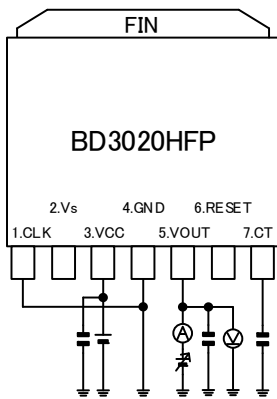

Measurement setup for Figure 8.

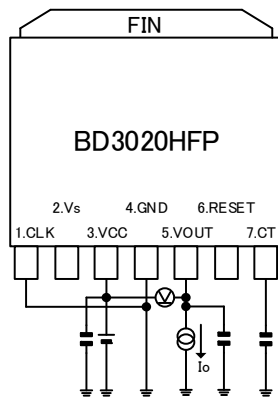

Measurement setup for Figure 9.

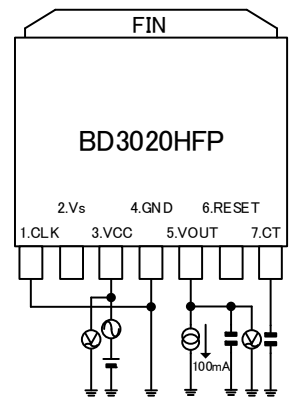

Measurement setup for Figure 10.

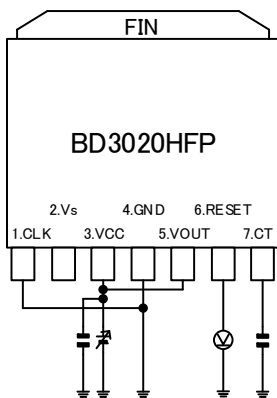

Measurement setup for Figure 13, 15.

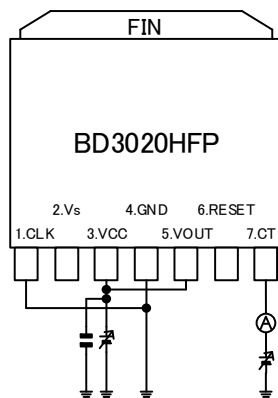

Measurement setup for Figure 14.

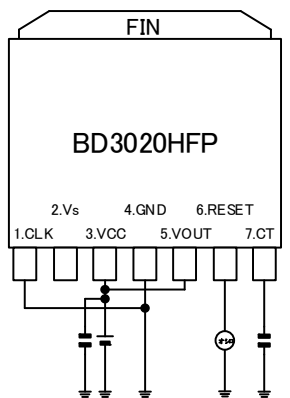

Measurement setup for Figure 16.

Measurement Circuits (BD3021HFP)

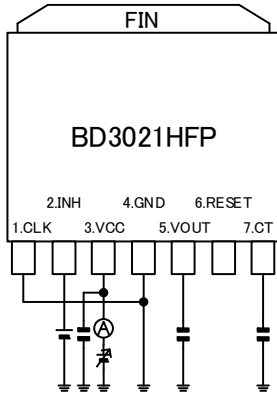

Measurement setup for Figure 5.

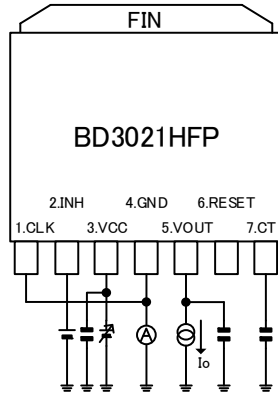

Measurement setup for Figure 6.

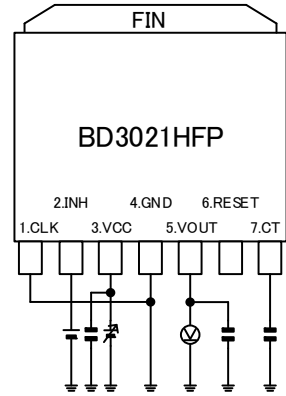

Measurement setup for Figure 7, 11, 12.

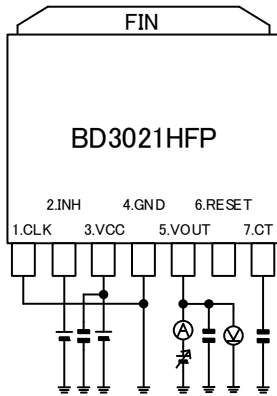

Measurement setup for Figure 8.

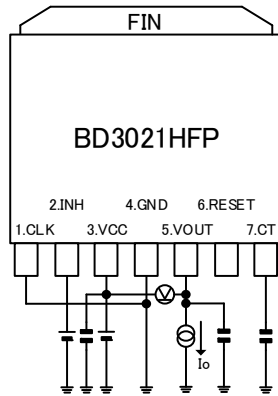

Measurement setup for Figure 9.

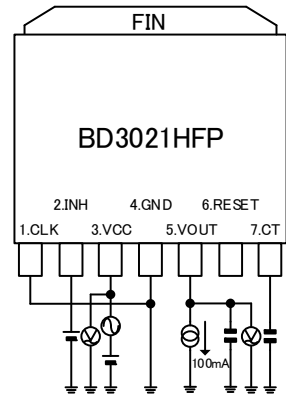

Measurement setup for Figure 10.

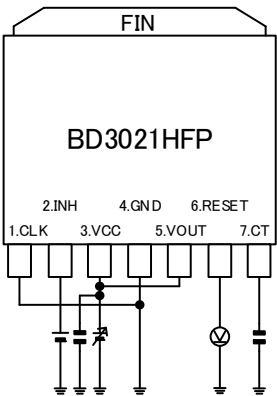

Measurement setup for Figure 13, 15.

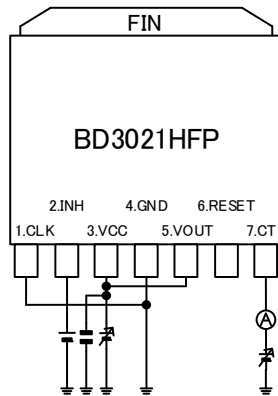

Measurement setup for Figure 14.

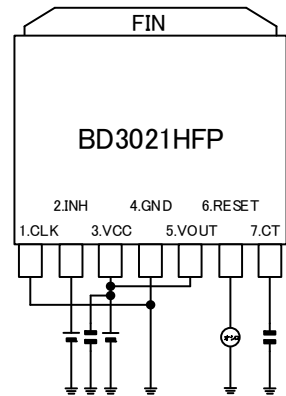

Measurement setup for Figure 16.

BD3020HFP Detection Voltage Adjustment (Resistance value is typical value)

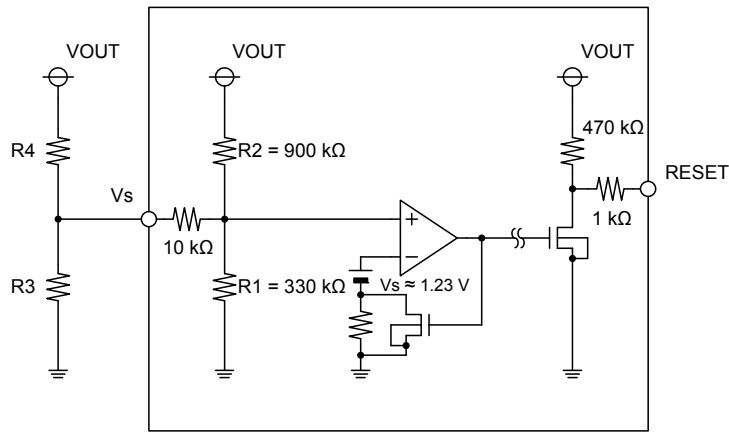

IC Internal Block Diagram

When typical detection voltage is 4.1 V

$$V_{det} \approx V_s \times (R_1 + R_2) / R_1$$

- V_{det} : Reset detection voltage
- V_s : Internal reference voltage (MOS input)
- R_1, R_2 : IC internal resistor

(Voltage detection precision is tightened up to $\pm 2\%$ by laser-trimming the R_1 and R_2)

V_s will fluctuate $1.23\text{ V} \pm 6.0\%$.

The reset detection voltage can be adjusted by connecting resistors on the V_s terminal.

Insert pull down resistor R_3 (lower resistance than R_1) in between V_s -GND, and pull down resistor R_4 (lower resistance than R_2) in between V_s -VOUT to adjust the detection voltage.

By doing so, the detection voltage can be adjusted by the calculation below.

$$V_{det} = V_s \times \left[\frac{R_2 \times R_4}{R_2 + R_4} + \frac{R_1 \times R_3}{R_1 + R_3} \right] / \left\{ \frac{R_1 \times R_3}{R_1 + R_3} \right\}$$

When the output resistance value is as small enough to ignore the IC internal resistance, you can find the detection voltage by the calculation below.

$$V_{det} \approx V_s \times (R_3 + R_4) / R_3$$

Adjust the resistance value by application as the circuit current will increase due to the added resistor.

BD3020/21HFP Power on Reset / Watchdog Timer

Power ON reset (output delay time) is adjustable by CT pin capacitor.

$$t_{dLH} (S) \approx (1.15 V \times CT \text{ capacitance } (\mu F)) / I_{ctc} (\mu A) (Typ)$$

- t_{dLH} : Output delay time (power ON reset)
- 1.15 V : Upper switching threshold voltage (Typ)
- CT capacitance : Capacitor connected to CT pin
- I_{ctc} : WDT charge current

Calculation example) with 0.01 μF CT pin capacitor

$$t_{dLH} (S) = 1.15 V \times 0.01 \mu F / 6 \mu A$$

$$\approx 1.9 \text{ ms}$$

*If the CT capacitance is not the same as the condition on the electrical characteristics table, i.e., 0.01 μF , choose the capacitance value in ratio referring to the above equation.

Watch Dog Timer (WDT t_{WH} , t_{WL}) is adjustable by the CT pin capacitor

$$t_{WH} (S) \approx 1.00 V \times CT \text{ capacitance } (\mu F) / I_{ctd}(\mu A) (Typ)$$

$$t_{WL} (S) \approx 1.00 V \times CT \text{ capacitance } (\mu F) / I_{ctc}(\mu A) (Typ)$$

- t_{WH} : Watchdog monitor time Low (delay time to turn the reset ON)
- t_{WL} : Watchdog reset time (time the reset is ON)
- 1.00 V : Upper switching threshold voltage - lower switching threshold voltage
- CT capacitance : CT pin capacitor *Shared with power ON reset
- I_{ctc} : WDT charge current
- I_{ctd} : WDT discharge current

Calculation example) with 0.01 μF CT pin capacitor

$$t_{WH} (S) \approx 1.00 V \times 0.01 \mu F / 2 \mu A \approx 5.0 \text{ ms (Typ)}$$

$$t_{WL} (S) \approx 1.00 V \times 0.01 \mu F / 6 \mu A \approx 1.7 \text{ ms (Typ)}$$

*If the CT capacitance is not the same as the condition on the electrical characteristics table, i.e., 0.01 μF , choose the capacitance value in ratio referring to the above equation.

<Timing Chart>

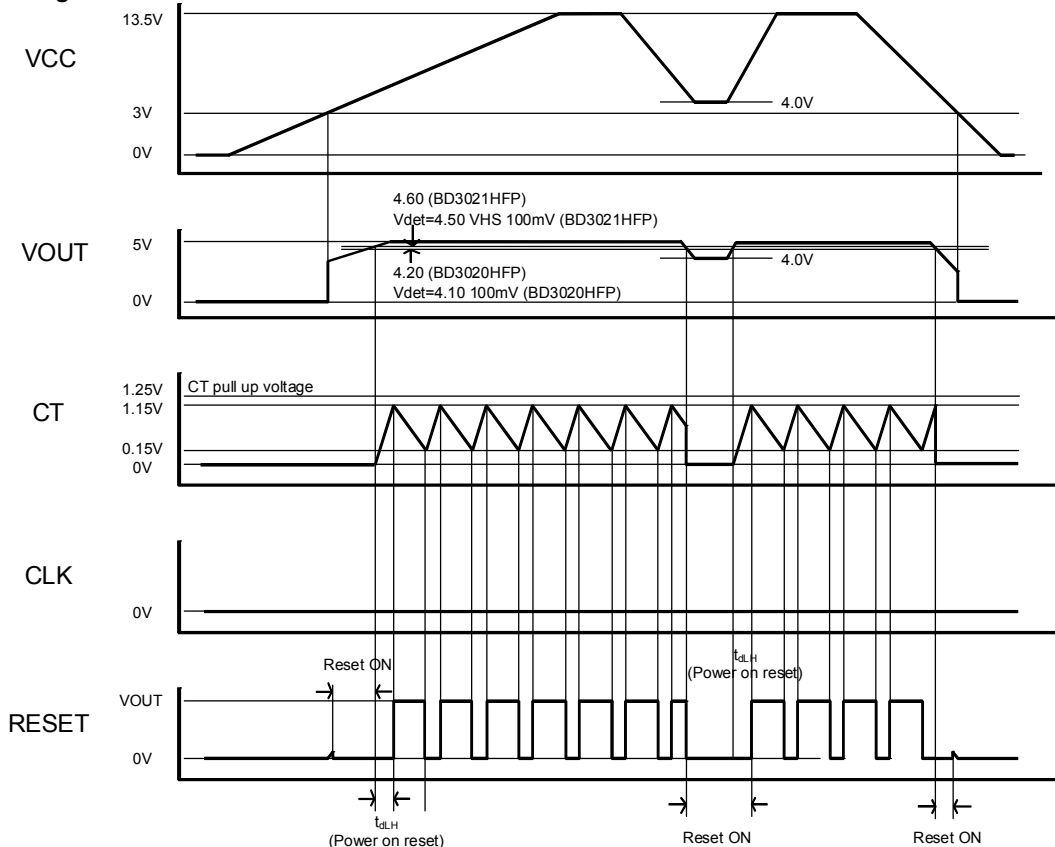

WDT timer ON / OFF switch INH (Resistance value is typical value)

BD3021HFP has a switch INH to turn the WDT ON / OFF.

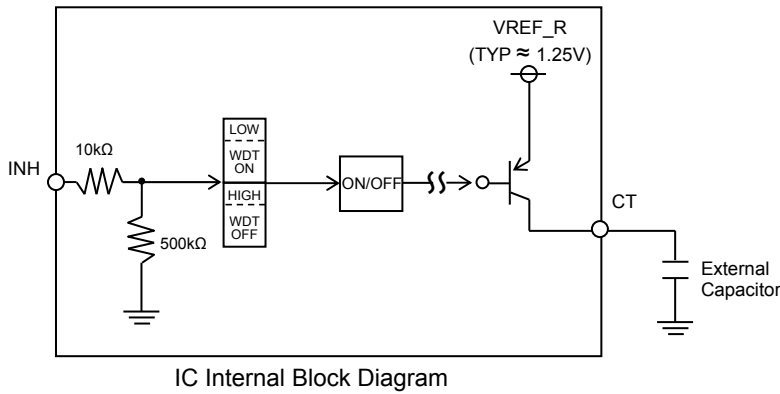

By using INH ON, CT potential can be pulled up to internal voltage VREF_R (invalid with power ON reset).

<Timing Chart> BD3021HFP

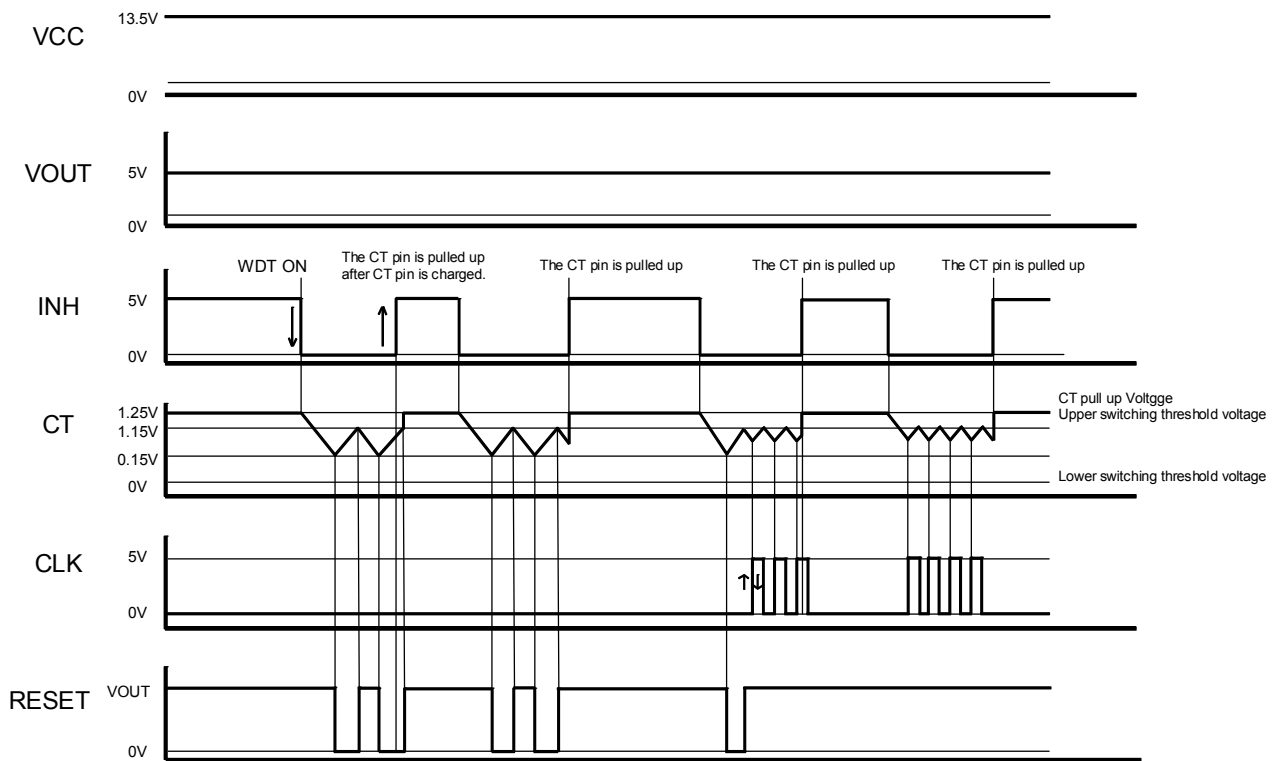

<Timing Chart> BD3020HFP

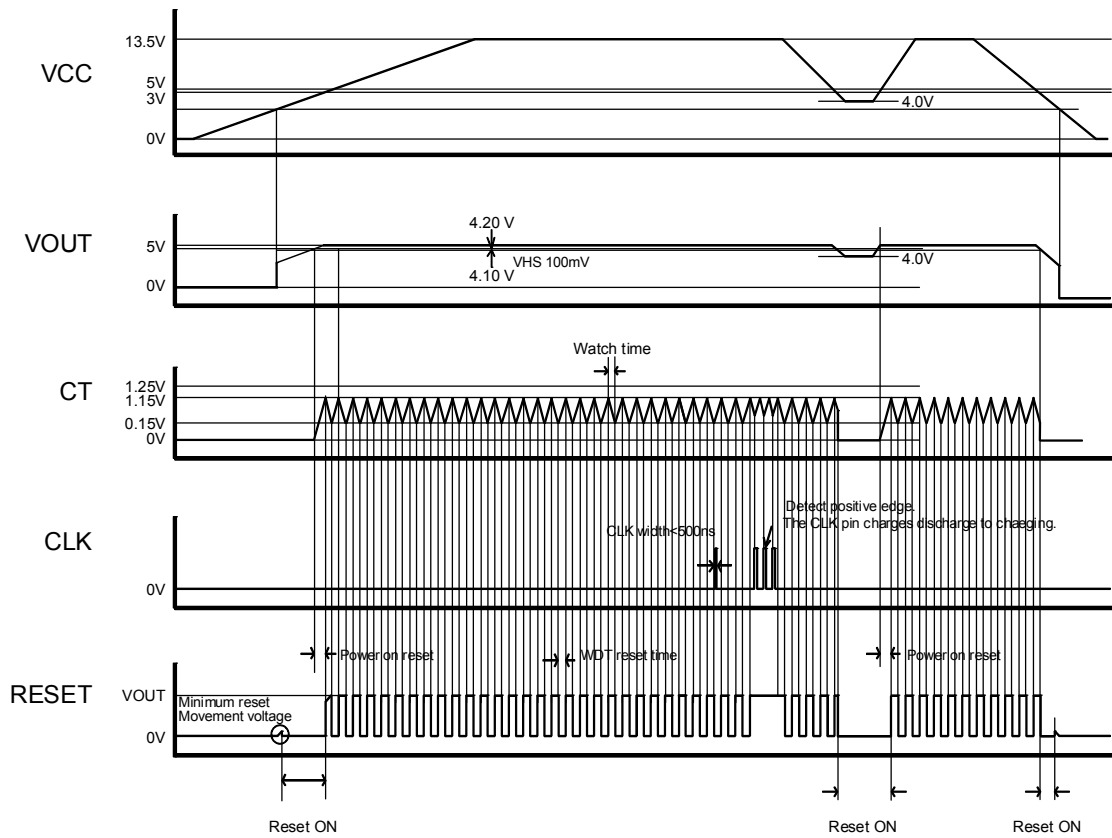

<Timing Chart> BD3021HFP

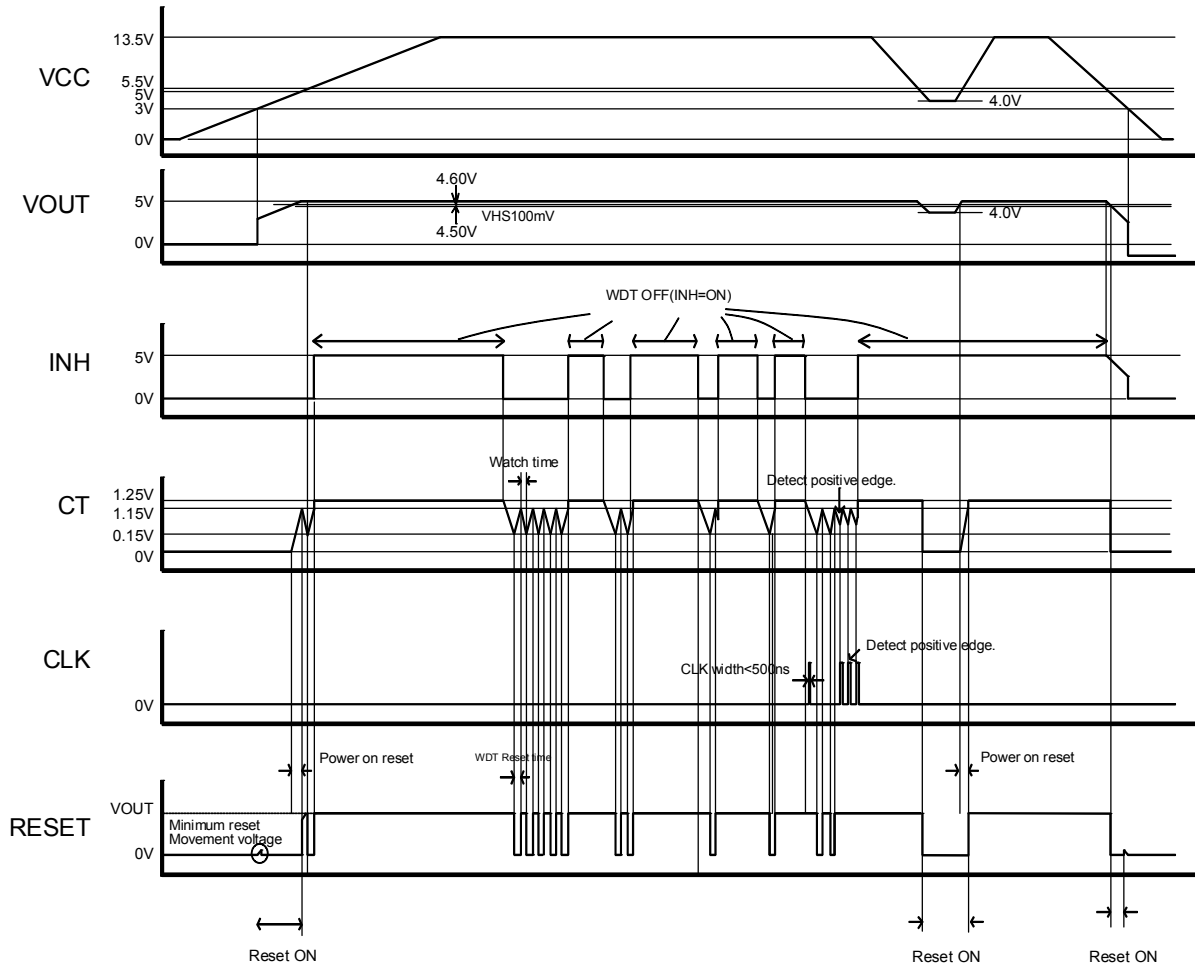

Pin Settings / Precautions

1. VCC Pin

Insert a 0.33 μF to 1000 μF capacitor between the VCC and GND. The appropriate capacitance value varies by application. Be sure to allow a sufficient margin for input voltage levels.

2. Output pins

In order to prevent oscillation, a capacitor needs to be placed between the output pin and GND. We recommend using a capacitor with a capacitance of 0.1 μF to 1000 μF . Electrolytic, tantalum and ceramic capacitors can be used. When selecting the capacitor ensure that the capacitance of 0.1 μF to 1000 μF is maintained at the intended applied voltage and temperature range. Due to changes in temperature the capacitor's capacitance can fluctuate possibly resulting in oscillation. For selection of the capacitor refer to the Cout_ESR vs. Io data. The stable operation range given in the reference data is based on the standalone IC and resistive load. For actual applications the stable operating range is influenced by the PCB impedance, input supply impedance and load impedance. Therefore verification of the final operating environment is needed.

Also, in case of rapidly changing input voltage and load current, select the capacitance in accordance with verifying that the actual application meets with the required specification.

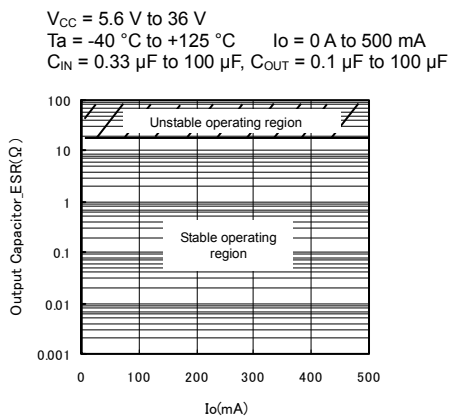

Output Capacitor_ESR vs Io (reference data)

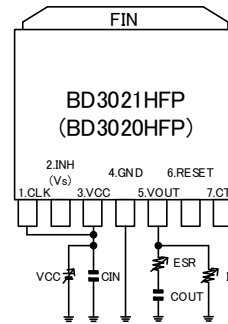

*Pin Settings / Precautions2 Measurement circuit

3. CT pin

Connecting a capacitance of 0.01 μF to 1 μF on the CT pin is recommended.

Power Dissipation

■HRP7

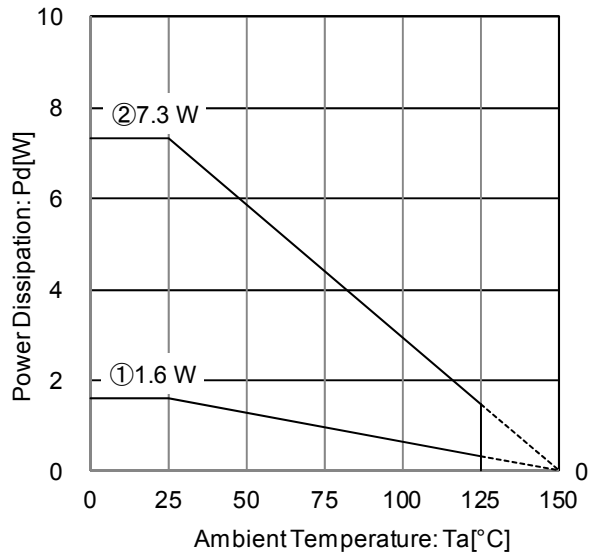

IC mounted on ROHM standard board.
 Board material: FR4
 Board size: 70.0 mm × 70.0 mm × 1.6 mm
 (with thermal via on the board)
 Mount condition: PCB and exposed pad are soldered.
 Top copper foil: The footprint ROHM recommend.
 + wiring to measure.

①: 1-layer PCB
 (Back surface copper foil area : 0mm × 0 mm)
 ②: 4-layer PCB
 (Back surface copper foil area : 70.0mm × 70.0 mm)

Condition①: $\theta_{ja} = 78.1 \text{ } ^\circ\text{C} / \text{W}$
 Condition②: $\theta_{ja} = 17.1 \text{ } ^\circ\text{C} / \text{W}$

Figure 17. Package Data (HRP7)

Refer to Figure 17 thermal dissipation characteristics for usage above $T_a = 25 \text{ } ^\circ\text{C}$. The IC's characteristics are affected heavily by the temperature, and if it exceeds its max junction temperature (T_{jmax}), the chip may degrade or destruct. Thermal design is critical in terms of avoiding Instantaneous destruction and reliability in long term usage. The IC needs to be operated below its max junction temperature (T_{jmax}) to avoid thermal destruction. Refer to Figure 17 for HRP7 package thermal dissipation characteristics. Operate the IC within power dissipation (Pd) when using this IC.

Power consumption P_c (W) calculation will be as below

$$P_c = (V_{CC} - V_{OUT}) \times I_o + V_{CC} \times I_{cc}$$

Power dissipation $P_d \geq P_c$

V_{CC} : Input Voltage
 V_{OUT} : Output Voltage
 I_o : Load Current
 I_{cc} : Circuit Current

If load current I_o is calculated to operate within power dissipation, it will be as below, where you can find the max load current I_{oMax} for the applied voltage V_{CC} of the thermal design.

$$I_o \leq \frac{P_d - V_{CC} \times I_{cc}}{V_{CC} - V_{OUT}} \quad (\text{Refer to Figure 6 for the } I_{cc})$$

■Example) at $T_a = 125 \text{ } ^\circ\text{C}$, $V_{CC} = 12 \text{ V}$, $V_{OUT} = 5 \text{ V}$

$$I_o \leq \frac{1.452 - 12 \times I_{cc}}{12 - 5}$$

$$I_o \leq 207 \text{ mA} \quad (I_{cc}: 150 \text{ } \mu\text{A})$$

$\left(\begin{array}{l} \theta_{ja} = 17.1 \text{ } ^\circ\text{C} / \text{W} \rightarrow -58.4 \text{ mV} / ^\circ\text{C} \\ 25 \text{ } ^\circ\text{C} = 7.30 \text{ W} \rightarrow 125 \text{ } ^\circ\text{C} = 1.452 \text{ W} \end{array} \right)$

At $T_a = 125 \text{ } ^\circ\text{C}$ with Figure 17 ② condition, the calculation shows that ca 207 mA of output current is possible at 7 V potential difference across input and output.

I/O Equivalence Circuit (Resistance value is typical value)

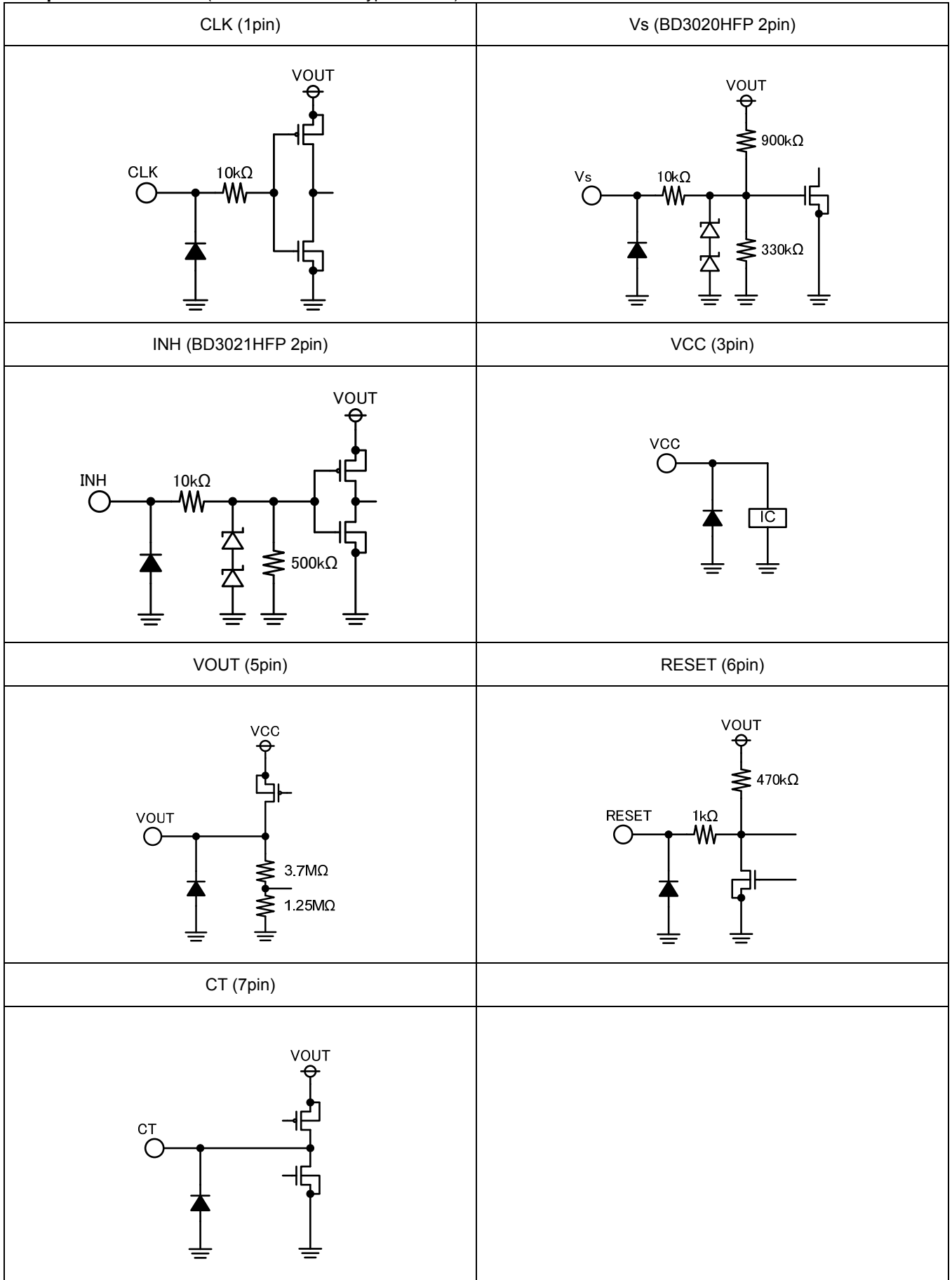

Figure 18. I / O equivalence circuit

Operational Notes**1. Electrical characteristics**

Electrical characteristics described in these specifications may vary, depending on temperature, supply voltage, external circuits and other conditions. Therefore, be sure to check all relevant factors, including transient characteristics.

2. Reverse Connection of Power Supply

Connecting the power supply in reverse polarity can damage the IC. Take precautions against reverse polarity when connecting the power supply, such as mounting an external diode between the power supply and the IC's power supply pins.

3. Power Supply Lines

Design the PCB layout pattern to provide low impedance supply lines. Separate the ground and supply lines of the digital and analog blocks to prevent noise in the ground and supply lines of the digital block from affecting the analog block. Furthermore, connect a capacitor to ground at all power supply pins. Consider the effect of temperature and aging on the capacitance value when using electrolytic capacitors.

4. Ground Voltage

Ensure that no pins are at a voltage below that of the ground pin at any time, even during transient condition.

5. Ground Wiring Pattern

When using both small-signal and large-current ground traces, the two ground traces should be routed separately but connected to a single ground at the reference point of the application board to avoid fluctuations in the small-signal ground caused by large currents. Also ensure that the ground traces of external components do not cause variations on the ground voltage. The ground lines must be as short and thick as possible to reduce line impedance.

6. Thermal Consideration

Should by any chance the power dissipation rating be exceeded the rise in temperature of the chip may result in deterioration of the properties of the chip. In case of exceeding this absolute maximum rating, increase the board size and copper area to prevent exceeding the Pd rating.

Use a thermal design that allows for a sufficient margin in light of the Pd in actual operating conditions. Consider Pc that does not exceed Pd in actual operating conditions. ($P_d \geq P_c$)

(Tjmax: Maximum junction temperature = 150 °C, Ta: Peripheral temperature [°C],
 θja: Thermal resistance of package-ambience [°C / W], Pd : Package Power dissipation [W],
 Pc: Power dissipation [W], Vcc: Input Voltage, Vout: Output Voltage, Io: Load, Icc2: Bias Current2)

Package Power dissipation : Pd (W) = (Tjmax - Ta) / θja
 Power dissipation : Pc (W) = (Vcc - Vout) × Io + Vcc × Icc2

7. Inrush Current

When power is first supplied to the IC, it is possible that the internal logic may be unstable and inrush current may flow instantaneously due to the internal powering sequence and delays, especially if the IC has more than one power supply. Therefore, give special consideration to power coupling capacitance, power wiring, width of ground wiring, and routing of connections.

8. Testing on Application Boards

When testing the IC on an application board, connecting a capacitor directly to a low-impedance output pin may subject the IC to stress. Always discharge capacitors completely after each process or step. The IC's power supply should always be turned off completely before connecting or removing it from the test setup during the inspection process. To prevent damage from static discharge, ground the IC during assembly and use similar precautions during transport and storage.

9. Inter-pin Short and Mounting Errors

Ensure that the direction and position are correct when mounting the IC on the PCB. Incorrect mounting may result in damaging the IC. Avoid nearby pins being shorted to each other especially to ground, power supply and output pin. Inter-pin shorts could be due to many reasons such as metal particles, water droplets (in very humid environment) and unintentional solder bridge deposited in between pins during assembly to name a few.

10. Unused Input Pins

Input pins of an IC are often connected to the gate of a MOS transistor. The gate has extremely high impedance and extremely low capacitance. If left unconnected, the electric field from the outside can easily charge it. The small charge acquired in this way is enough to produce a significant effect on the conduction through the transistor and cause unexpected operation of the IC. So unless otherwise specified, unused input pins should be connected to the power supply or ground line.

Operational Notes – continued

11. Regarding the Input Pin of the IC

This monolithic IC contains P+ isolation and P substrate layers between adjacent elements in order to keep them isolated. P-N junctions are formed at the intersection of the P layers with the N layers of other elements, creating a parasitic diode or transistor. For example (refer to figure below):

When GND > Pin A and GND > Pin B, the P-N junction operates as a parasitic diode.
 When GND > Pin B, the P-N junction operates as a parasitic transistor.

Parasitic diodes inevitably occur in the structure of the IC. The operation of parasitic diodes can result in mutual interference among circuits, operational faults, or physical damage. Therefore, conditions that cause these diodes to operate, such as applying a voltage lower than the GND voltage to an input pin (and thus to the P substrate) should be avoided.

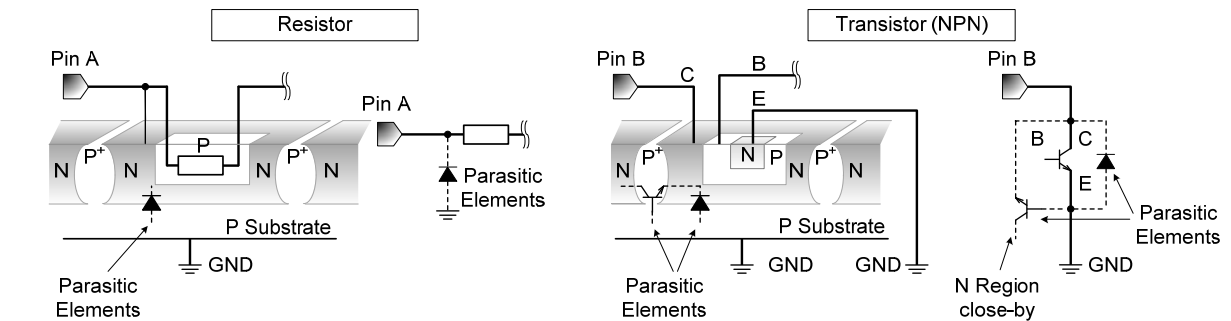

Figure 19. Example of monolithic IC structure

12. Thermal Shutdown Circuit(TSD)

This IC has a built-in thermal shutdown circuit that prevents heat damage to the IC. Normal operation should always be within the IC's power dissipation rating. If however the rating is exceeded for a continued period, the junction temperature (Tj) will rise which will activate the TSD circuit that will turn OFF all output pins. When the Tj falls below the TSD threshold, the circuits are automatically restored to normal operation.

Note that the TSD circuit operates in a situation that exceeds the absolute maximum ratings and therefore, under no circumstances, should the TSD circuit be used in a set design or for any purpose other than protecting the IC from heat damage.

13. Over Current Protection Circuit (OCP)

This IC incorporates an integrated overcurrent protection circuit that is activated when the load is shorted. This protection circuit is effective in preventing damage due to sudden and unexpected incidents. However, the IC should not be used in applications characterized by continuous operation or transitioning of the protection circuit.

14. Applications or inspection processes where the potential of the VCC pin or other pins may be reversed from their normal state may cause damage to the IC's internal circuitry or elements. Use an output pin capacitance of 1000µF or lower in case VCC is shorted with the GND pin while the external capacitor is charged. Insert a diode in series with VCC to prevent reverse current flow, or insert bypass diodes between VCC and each pin.

15. Positive voltage surges on VCC pin

A power zener diode should be inserted between VCC and GND for protection against voltage surges of more than 50 V on the VCC pin.

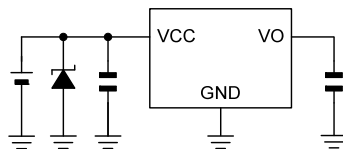

Figure 20. Application Examples 1

16. Negative voltage surges on VCC pin

A schottky barrier diode should be inserted between VCC and GND for protection against voltages lower than GND on the VCC pin.

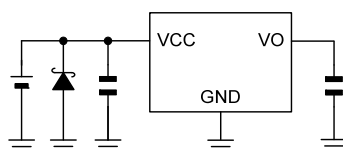

Figure 21. Application Examples 2

Operational Notes – continued

17. Output protection diode

Loads with large inductance components may cause reverse current flow during startup or shutdown. In such cases, a protection diode should be inserted on the output to protect the IC.

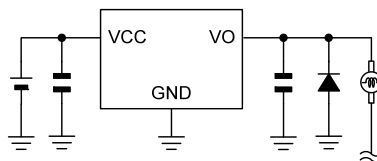
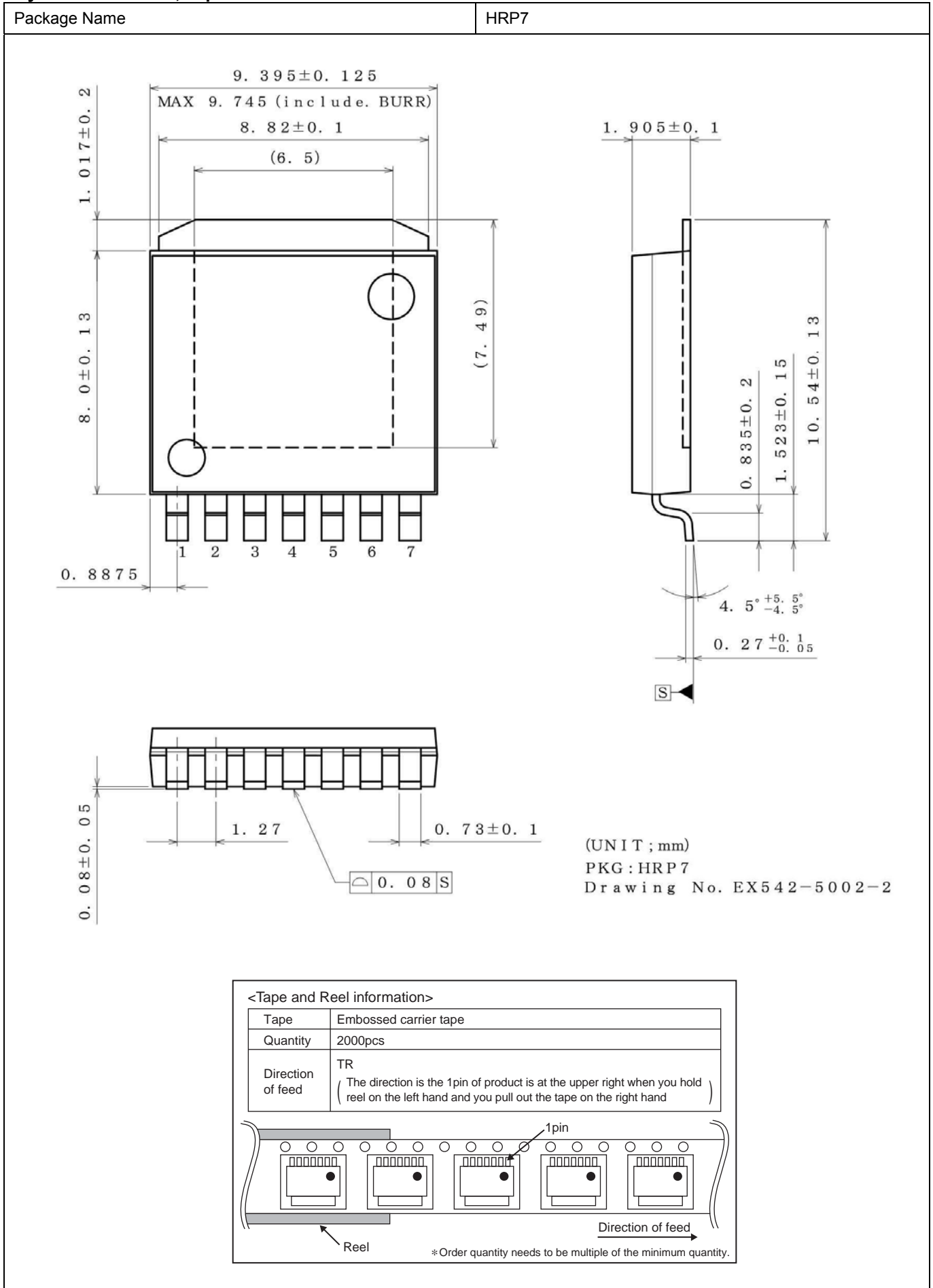
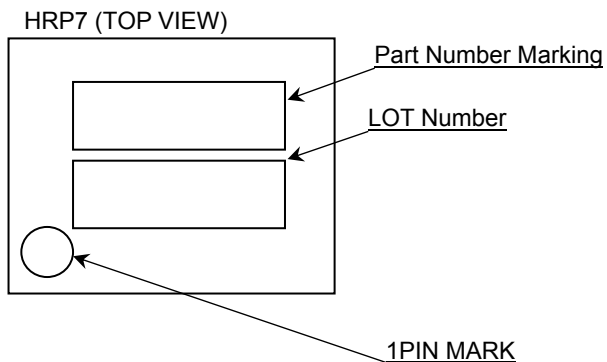

Figure 22. Application Examples 3

Physical Dimension, Tape and Reel Information



Marking Diagram



Product Name	Part Number Marking
BD3020HFP	BD3020
BD3021HFP	BD3021

Revision History

Date	Revision	Changes
10.Nov.2015	001	New Release

Notice

Precaution on using ROHM Products

1. If you intend to use our Products in devices requiring extremely high reliability (such as medical equipment ^(Note 1), aircraft/spacecraft, nuclear power controllers, etc.) and whose malfunction or failure may cause loss of human life, bodily injury or serious damage to property ("Specific Applications"), please consult with the ROHM sales representative in advance. Unless otherwise agreed in writing by ROHM in advance, ROHM shall not be in any way responsible or liable for any damages, expenses or losses incurred by you or third parties arising from the use of any ROHM's Products for Specific Applications.

(Note1) Medical Equipment Classification of the Specific Applications

JAPAN	USA	EU	CHINA
CLASS III	CLASS III	CLASS II b	CLASS III
CLASS IV		CLASS III	

2. ROHM designs and manufactures its Products subject to strict quality control system. However, semiconductor products can fail or malfunction at a certain rate. Please be sure to implement, at your own responsibilities, adequate safety measures including but not limited to fail-safe design against the physical injury, damage to any property, which a failure or malfunction of our Products may cause. The following are examples of safety measures:
 - [a] Installation of protection circuits or other protective devices to improve system safety
 - [b] Installation of redundant circuits to reduce the impact of single or multiple circuit failure
3. Our Products are not designed under any special or extraordinary environments or conditions, as exemplified below. Accordingly, ROHM shall not be in any way responsible or liable for any damages, expenses or losses arising from the use of any ROHM's Products under any special or extraordinary environments or conditions. If you intend to use our Products under any special or extraordinary environments or conditions (as exemplified below), your independent verification and confirmation of product performance, reliability, etc, prior to use, must be necessary:
 - [a] Use of our Products in any types of liquid, including water, oils, chemicals, and organic solvents
 - [b] Use of our Products outdoors or in places where the Products are exposed to direct sunlight or dust
 - [c] Use of our Products in places where the Products are exposed to sea wind or corrosive gases, including Cl₂, H₂S, NH₃, SO₂, and NO₂
 - [d] Use of our Products in places where the Products are exposed to static electricity or electromagnetic waves
 - [e] Use of our Products in proximity to heat-producing components, plastic cords, or other flammable items
 - [f] Sealing or coating our Products with resin or other coating materials
 - [g] Use of our Products without cleaning residue of flux (even if you use no-clean type fluxes, cleaning residue of flux is recommended); or Washing our Products by using water or water-soluble cleaning agents for cleaning residue after soldering
 - [h] Use of the Products in places subject to dew condensation
4. The Products are not subject to radiation-proof design.
5. Please verify and confirm characteristics of the final or mounted products in using the Products.
6. In particular, if a transient load (a large amount of load applied in a short period of time, such as pulse. is applied, confirmation of performance characteristics after on-board mounting is strongly recommended. Avoid applying power exceeding normal rated power; exceeding the power rating under steady-state loading condition may negatively affect product performance and reliability.
7. De-rate Power Dissipation depending on ambient temperature. When used in sealed area, confirm that it is the use in the range that does not exceed the maximum junction temperature.
8. Confirm that operation temperature is within the specified range described in the product specification.
9. ROHM shall not be in any way responsible or liable for failure induced under deviant condition from what is defined in this document.

Precaution for Mounting / Circuit board design

1. When a highly active halogenous (chlorine, bromine, etc.) flux is used, the residue of flux may negatively affect product performance and reliability.
2. In principle, the reflow soldering method must be used on a surface-mount products, the flow soldering method must be used on a through hole mount products. If the flow soldering method is preferred on a surface-mount products, please consult with the ROHM representative in advance.

For details, please refer to ROHM Mounting specification

Precautions Regarding Application Examples and External Circuits

1. If change is made to the constant of an external circuit, please allow a sufficient margin considering variations of the characteristics of the Products and external components, including transient characteristics, as well as static characteristics.
2. You agree that application notes, reference designs, and associated data and information contained in this document are presented only as guidance for Products use. Therefore, in case you use such information, you are solely responsible for it and you must exercise your own independent verification and judgment in the use of such information contained in this document. ROHM shall not be in any way responsible or liable for any damages, expenses or losses incurred by you or third parties arising from the use of such information.

Precaution for Electrostatic

This Product is electrostatic sensitive product, which may be damaged due to electrostatic discharge. Please take proper caution in your manufacturing process and storage so that voltage exceeding the Products maximum rating will not be applied to Products. Please take special care under dry condition (e.g. Grounding of human body / equipment / solder iron, isolation from charged objects, setting of Ionizer, friction prevention and temperature / humidity control).

Precaution for Storage / Transportation

1. Product performance and soldered connections may deteriorate if the Products are stored in the places where:
 - [a] the Products are exposed to sea winds or corrosive gases, including Cl₂, H₂S, NH₃, SO₂, and NO₂
 - [b] the temperature or humidity exceeds those recommended by ROHM
 - [c] the Products are exposed to direct sunshine or condensation
 - [d] the Products are exposed to high Electrostatic
2. Even under ROHM recommended storage condition, solderability of products out of recommended storage time period may be degraded. It is strongly recommended to confirm solderability before using Products of which storage time is exceeding the recommended storage time period.
3. Store / transport cartons in the correct direction, which is indicated on a carton with a symbol. Otherwise bent leads may occur due to excessive stress applied when dropping of a carton.
4. Use Products within the specified time after opening a humidity barrier bag. Baking is required before using Products of which storage time is exceeding the recommended storage time period.

Precaution for Product Label

QR code printed on ROHM Products label is for ROHM's internal use only.

Precaution for Disposition

When disposing Products please dispose them properly using an authorized industry waste company.

Precaution for Foreign Exchange and Foreign Trade act

Since concerned goods might be fallen under listed items of export control prescribed by Foreign exchange and Foreign trade act, please consult with ROHM in case of export.

Precaution Regarding Intellectual Property Rights

1. All information and data including but not limited to application example contained in this document is for reference only. ROHM does not warrant that foregoing information or data will not infringe any intellectual property rights or any other rights of any third party regarding such information or data.
2. ROHM shall not have any obligations where the claims, actions or demands arising from the combination of the Products with other articles such as components, circuits, systems or external equipment (including software).
3. No license, expressly or implied, is granted hereby under any intellectual property rights or other rights of ROHM or any third parties with respect to the Products or the information contained in this document. Provided, however, that ROHM will not assert its intellectual property rights or other rights against you or your customers to the extent necessary to manufacture or sell products containing the Products, subject to the terms and conditions herein.

Other Precaution

1. This document may not be reprinted or reproduced, in whole or in part, without prior written consent of ROHM.
2. The Products may not be disassembled, converted, modified, reproduced or otherwise changed without prior written consent of ROHM.
3. In no event shall you use in any way whatsoever the Products and the related technical information contained in the Products or this document for any military purposes, including but not limited to, the development of mass-destruction weapons.
4. The proper names of companies or products described in this document are trademarks or registered trademarks of ROHM, its affiliated companies or third parties.

General Precaution

1. Before you use our Products, you are requested to carefully read this document and fully understand its contents. ROHM shall not be in any way responsible or liable for failure, malfunction or accident arising from the use of any ROHM's Products against warning, caution or note contained in this document.
2. All information contained in this document is current as of the issuing date and subject to change without any prior notice. Before purchasing or using ROHM's Products, please confirm the latest information with a ROHM sales representative.
3. The information contained in this document is provided on an "as is" basis and ROHM does not warrant that all information contained in this document is accurate and/or error-free. ROHM shall not be in any way responsible or liable for any damages, expenses or losses incurred by you or third parties resulting from inaccuracy or errors of or concerning such information.



BD3021HFP - Web Page

Part Number	BD3021HFP
Package	HRP7
Unit Quantity	2000
Minimum Package Quantity	2000
Packing Type	Taping
Constitution Materials List	inquiry
RoHS	Yes