

03 KGR

Circular connectors with threaded joint M16 acc. to IEC 61076-2-106, IP40/IP67/IP68



Chassis socket acc. to IEC 61076-2-106, IP 40, with threaded joint, for printed circuit boards, for back side mounting

**03 KGR**

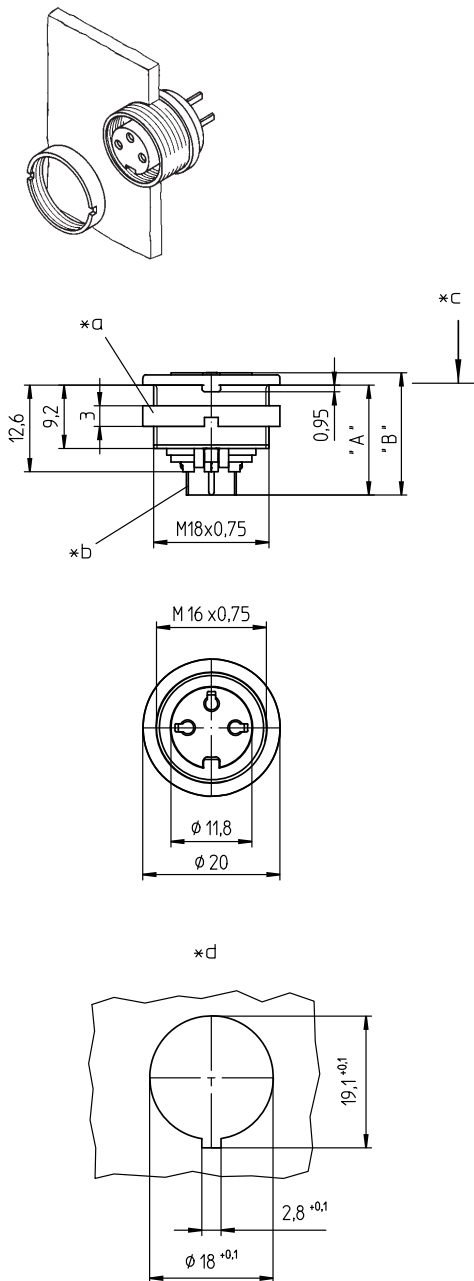

**Environmental conditions**

Temperature range -40 °C/+85 °C

**Materials**

Insulating body PA GF, V-0 according to UL94  
 Contact bush CuZn, silver-plated and flash gold-plated, tin-plated in solder area (3-8 poles)  
 CuZn, pre-nickel and gold-plated, tin-plated in solder area (12 poles)  
 Housing Zn diecast, pre-copper and nickel-plated  
 Ring screw CuZn, nickel-plated

**Mechanical data**

Insertion force/contact ≤ 5.0 N<sup>1</sup>  
 Withdrawal force/contact ≥ 1.2 N (3-8 poles)  
 ≥ 0.9 N (12 poles)<sup>1</sup>  
 Protection class IP40<sup>2</sup>

<sup>1</sup> measured with a polished steel pin, nominal thickness 1.5 mm (1.0 mm with 12 poles)  
<sup>2</sup> according to IEC DIN EN 60529, only in locked condition with an appropriate counterpart

**Electrical data (at T<sub>amb</sub> 20 °C)**

Contact resistance ≤ 5 mΩ  
 Rated current 5 A (T<sub>amb</sub> 40 °C, 3-8 poles)  
 3 A (T<sub>amb</sub> 40 °C, 12 poles)  
 Rated voltage with pollution degree 1:  
 300 V (versions 30, 40, 50/6, 60, 70)  
 100 V (versions 50, 71, 80, 81)  
 160 V (Polbild 120)  
 with pollution degree 2:  
 250 V (versions 30, 40)  
 32 V (versions 50, 71, 80, 81)  
 160 V (versions 50/6, 60, 70, 120)  
 Rated impulse voltage 1500 V (versions 30, 40, 50/6, 60, 70, 120)  
 500 V (versions 50, 71, 80, 81)  
 Material group II (IEC)/I (UL) (CTI ≥ 550)  
 Overvoltage category I  
 Insulation resistance > 100 MΩ

**Associated products**

Counterparts  
 ☞ SV ☞ SV ...-8 ☞ WSV  
 Accessories  
 ☞ 0381 ☞ 038199 ☞ 0384  
 ☞ 038799

**03 KGR**

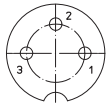

**03-a**  
KGR 30

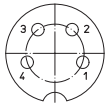

**04-a**  
KGR 40

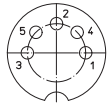

**05-b**  
KGR 50

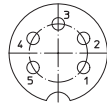

**05-a**  
KGR 50/6

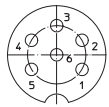

**06-a**  
KGR 60

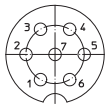

**07-a**  
KGR 70

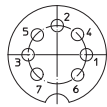

**07-b**  
KGR 71

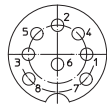

**KGR 80**



**08-a**  
KGR 81



**12-a**  
KGR 120

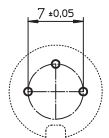

**03-a**  
KGR 30

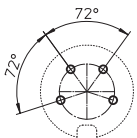

**04-a**  
KGR 40

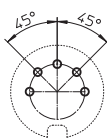

**05-b**  
KGR 50

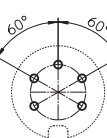

**05-a**  
KGR 50/6

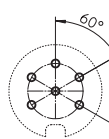

**06-a**  
KGR 60

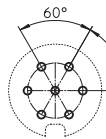

**07-a**  
KGR 70

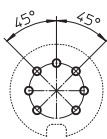

**07-b**  
KGR 71

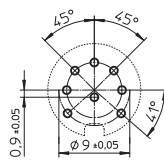

**KGR 80**

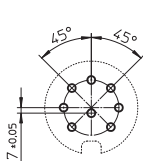

**08-a**  
KGR 81

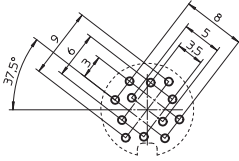

**12-a**  
KGR 120

03 KGR

- 
- \*a nut enclosed separately
  - \*b for bore hole of printed circuit board  
Ø 1.0 mm (KGR 30-81)  
Ø 0.7 mm (KGR 120)
  - \*c mounting direction
  - \*d 12 pole version Ø 1.0 mm
  - \*e port in mounting plate

03 KGR

Designation	Pole Number	PU (Pieces)	MDQ (Pieces)	Dimensions	
				A (mm)	B (mm)
KGR 30	3	50	100	8.2	17.8
KGR 40	4	50	100	8.2	17.8
KGR 50	5	50	100	8.2	17.8
KGR 50/6	5	50	100	8.2	17.8
KGR 60	6	50	100	8.2	17.8
KGR 70	7	50	100	8.2	17.8
KGR 71	7	50	100	8.2	17.8
KGR 80	8	50	100	8.2	17.8
KGR 81	8	50	100	8.2	17.8
KGR 120	12	50	100	7.9	17.1

**Packaging:**  
in a cardboard box