

KEY FEATURES

- Switching Power Module for PCB Mountable
- Fully Encapsulated Plastic Case
- Universal Input Range 90-264VAC, 47-440 Hz
- Regulated Output
- Low Ripple and Noise
- CE, UL Approval
- 3-Year Product Warranty



ELECTRICAL SPECIFICATIONS

All specifications valid at normal input voltage, full load and +25°C after warm-up time unless otherwise stated.

Model No. (Single Output)	ANC-5S A-E1	ANC-12S A-E1	ANC-15S A-E1	ANC-24S A-E1	
Max Output Wattage (W)	15W	15W	15W	15W	
Input	Voltage				
	90-264 VAC or 120-370 VDC				
	Frequency (Hz)				
	47-440 Hz				
	Current (Full load)				
	310 mA max. (115 VAC) / 170 mA max. (230 VAC)				
Input	Inrush Current (<2ms)				
	23 A max. (115 VAC) / 46 A max. (230 VAC)				
	Leakage Current				
	0.75 mA max.				
	External Fuse (recommend)				
	1.5 A slow blow type				
Output	Voltage (V.DC.)	5V	12V	15V	24V
	Voltage Accuracy	±2%			
	Current (mA) max	3000	1250	1000	625
	Line Regulation (LL-HL) (typ.)	±0.5%			
	Load Regulation (5-100%) (typ.)	±0.5%			
	Minimum Load	4%	2%	0%	0%
	Maximum Capacitive Load	31000 uF	4500 uF	2700 uF	900 uF
	Ripple	<0.2% Vout +40mV max (Vp-p)			
	Noise	<0.5% Vout +50mV max (Vp-p)			
	Efficiency	74%	79%	78%	80%
	Hold-up Time	15 ms min.			
Protection	Over Power Protection	Hiccup technique, auto-recovery			
	Over Voltage Protection	Zener diode clamp			
	Short Circuit Protection	Hiccup mode, indefinite (automatic recovery)			
Isolation	Input-Output (V.AC)	3000V			
	Input-FG (V.AC)	1500V			
	Output-FG (V.AC)	500V			
Environment	Operating Temperature	-40°C...+70°C (with derating)			
	Storage Temperature	-40°C...+85°C			
	Temperature Coefficient	±0.02%/°C			
	Humidity	95% RH			
	MTBF	>200,000 h @ 25°C (MIL-HDBK-217F)			
Physical	Dimension (L x W x H)	2.91 x 2.13 x 0.86 Inches (74.1 x 54.1 x 21.8 mm) Tolerance ±0.5 mm			
	Case Material	Plastic resin (flammability to UL 94V-0)			
	Weight	114 g			
	Cooling Method	Free air convection			
Safety	Agency Approvals	UL/cUL, CE			
EMC	EMI (Conducted & Radiated Emission)	EN 55022 class B			
	EMS (Noise Immunity)	EN 55024			

ELECTRICAL SPECIFICATIONS

All specifications valid at normal input voltage, full load and +25°C after warm-up time unless otherwise stated.

Model No. (Dual / Triple Output)	ANC-5D A -E1	ANC-12D A -E1	ANC-15D A -E1	ANC-5S12D A -E1	ANC-5S15D A -E1		
Max Output Wattage (W)	15W	15W	15W	15W	15W		
Input	Voltage						
	90-264 VAC or 120-370 VDC						
	Frequency (Hz)						
	47-440 Hz						
	Current (Full load)						
	310 mA max. (115 VAC) / 170 mA max. (230 VAC)						
Inrush Current (<2ms)							
23 A max. (115 VAC) / 46 A max. (230 VAC)							
Leakage Current							
0.75 mA max.							
External Fuse (recommend)							
1.5 A slow blow type							
Output	Voltage (V.DC.)		±5V	±12V	±15V	5/±12	5/±15
	Voltage Accuracy		±5%		±3%		
	Current (mA) max		±1500	±650	±500	2000/±200	2000/±150
	Line Regulation (LL-HL) (typ.)		±0.5%			±1% / ±5%	
	Load Regulation (5-100%) (typ.)		±3%			±2% / ±5%	
	Minimum Load		0%			5V 10% (200 mA)	
	Maximum Capacitive Load		±13500 uF	±2700 uF	±1400 uF	14000 / ±900 uF	14000 / ±680 uF
	Ripple		<0.2% Vout +40mV max (Vp-p)				
	Noise		<0.5% Vout +50mV max (Vp-p)				
	Efficiency		76%	79%	77%	73%	73%
	Hold-up Time		15 ms min.				
Protection	Over Power Protection		Hiccup technique, auto-recovery				
	Over Voltage Protection		Zener diode clamp				
	Short Circuit Protection		Hiccup mode, indefinite (automatic recovery)				
Isolation	Input-Output (V.AC)		3000V				
	Input-FG (V.AC)		1500V				
	Output-FG (V.AC)		500V				
Environment	Operating Temperature		-40°C...+70°C (with derating)				
	Storage Temperature		-40°C...+85°C				
	Temperature Coefficient		±0.02%/°C				
	Humidity		95% RH				
	MTBF		>200,000 h @ 25°C (MIL-HDBK-217F)				
Physical	Dimension (L x W x H)		2.91 x 2.13 x 0.86 Inches (74.1 x 54.1 x 21.8 mm) Tolerance ±0.5 mm				
	Case Material		Plastic resin (flammability to UL 94V-0)				
	Weight		114 g				
	Cooling Method		Free air convection				
Safety	Agency Approvals		UL/cUL, CE				
EMC	EMI (Conducted & Radiated Emission)		EN 55022 class B				
	EMS (Noise Immunity)		EN 55024				

NOTE

1. Ripple & Noise are measured at 20MHz of bandwidth with 0.1uF & 47uF parallel capacitor.
2. It's recommended to add Varistor 14S471K at L / N input side in parallel.
3. Please refer to our PDF file "AC-DC Application" on our website: www.archcorp.com.tw

MECHANICAL DIMENSION (Top View)

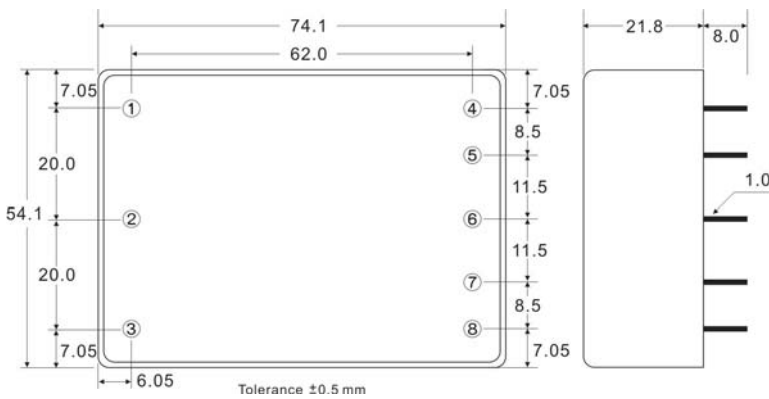

PIN#	Single	Dual	Triple
1	FG	FG	FG
2	AC IN (N)	AC IN (N)	AC IN (N)
3	AC IN (L)	AC IN (L)	AC IN (L)
4	NO PIN	NO PIN	-DC OUT
5	-DC OUT	-DC OUT	COMMON
6	NO PIN	COMMON	+DC OUT
7	+DC OUT	+DC OUT	+5V RTN
8	NO PIN	NO PIN	+5V OUT

BLOCK DIAGRAM

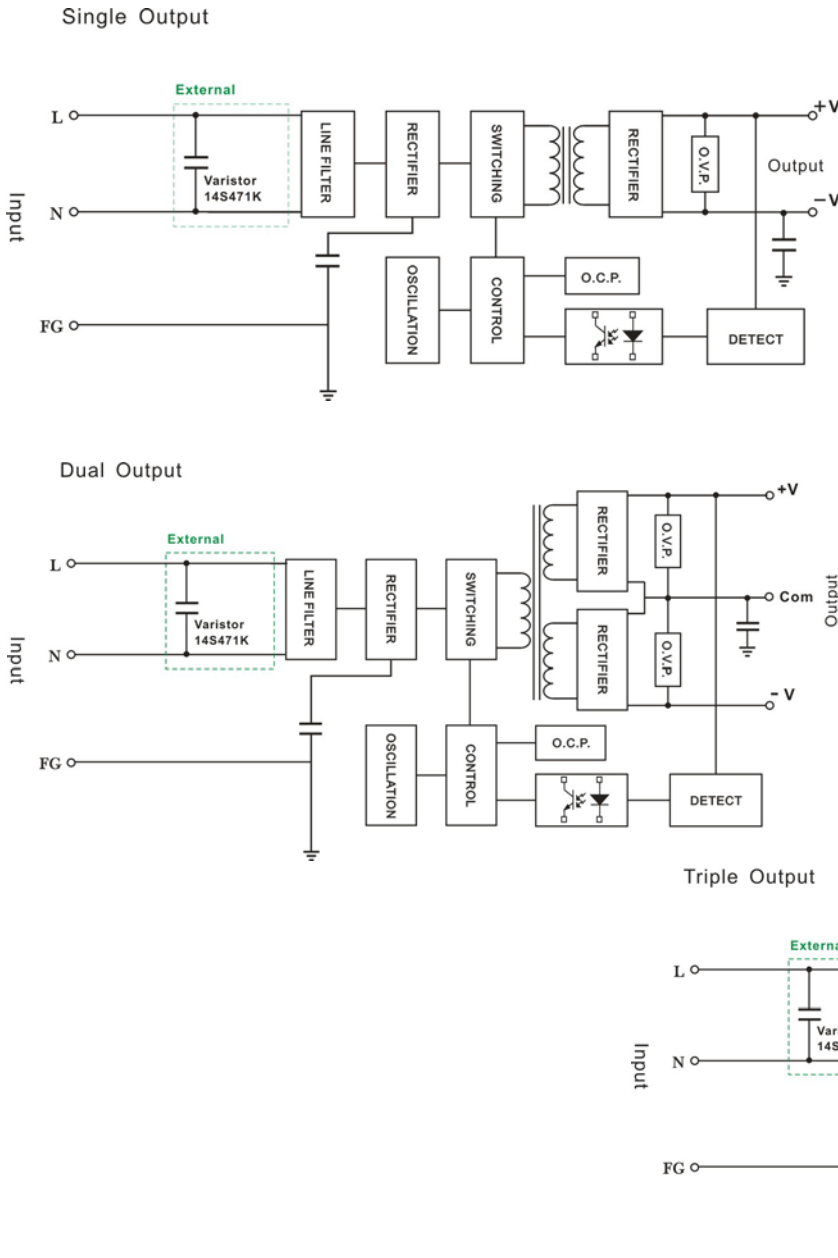

DERATING

