

# TCP-5056UB

## 5.6 pF Passive Tunable Integrated Circuits (PTIC)

### Introduction

ON Semiconductor's PTICs have excellent RF performance and power consumption, making them suitable for any mobile handset or radio application. The fundamental building block of our PTIC product line is a tunable material called ParaScan™, based on Barium Strontium Titanate (BST). PTICs have the ability to change their capacitance from a supplied bias voltage generated by the Control IC. The 5.6 pF ultra-high tuning PTICs are available as wafer-level chip scale packages (WLCSP).

### Key Features

- Ultra-High Tuning Range(5:1) and Operation up to 24 V
- Usable Frequency Range: from 700 MHz to 2.7 GHz
- High Quality Factor (Q) for Low Loss
- High Power Handling Capability
- Compatible with PTIC Control ICs from ON Semiconductor
- These devices are Pb-Free and RoHS Compliant

### Typical Applications

- Multi-band, Multi-standard, Advanced and Simple Mobile Phones
- Tunable Antenna Matching Networks
- Tunable RF Filters
- Active Antennas



**ON Semiconductor®**

[www.onsemi.com](http://www.onsemi.com)



**WLCSP6**  
**1.097x0.622**  
**CASE 567NZ**

### MARKING DIAGRAM



G = Specific Device Code  
Y = Year  
W = Work Week

### FUNCTIONAL BLOCK DIAGRAM

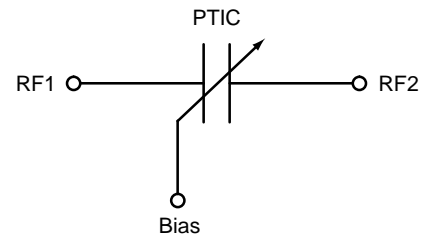

**PTIC Functional Block Diagram**

### ORDERING INFORMATION

| Device        | Package             | Shipping†                      |
|---------------|---------------------|--------------------------------|
| TCP-5056UB-DT | WLCSP6<br>(Pb-Free) | 4000 Units /<br>7" Tape & Reel |

†For information on tape and reel specifications, including part orientation and tape sizes, please refer to our Tape and Reel Packaging Specifications Brochure, BRD8011/D.

# TCP-5056UB



**Figure 1. PTIC Functional Block Diagram (Top View)**

**Table 1. SIGNAL DESCRIPTIONS**

| Ball / Pad Number | Pin Name  | Description     |
|-------------------|-----------|-----------------|
| A1                | DC Bias 1 | DC Bias Voltage |
| B1                | RF2       | RF Output       |
| C1                | RF2       | RF Output       |
| A2                | NC        | Not Connected   |
| B2                | RF1       | RF Input        |
| C2                | RF1       | RF Input        |

# TCP-5056UB

## TYPICAL SPECIFICATIONS

### Representative Performance Data at 25°C

**Table 2. PERFORMANCE DATA**

| Parameter  | Min   | Typ   | Max   | Units         |
|--|-------|-------|-------|---------------|
| Operating Bias Voltage                                       | 1.0   |       | 24    | V             |
| Capacitance ( $V_{bias} = 2\text{ V}$ )                      | 5.096 | 5.6   | 6.104 | pF            |
| Capacitance ( $V_{bias} = 24\text{ V}$ )                     | 1.096 | 1.204 | 1.313 | pF            |
| Tuning Range (1 V – 24 V)                                    | 4.80  | 5.25  | 6.00  |               |
| Tuning Range (2 V – 24 V)                                    | 4.20  | 4.65  | 5.30  |               |
| Leakage Current ( $V_{bias} = 24\text{ V}$ )                 |       |       | 0.1   | $\mu\text{A}$ |
| Operating Frequency  | 700   |       | 2700  | MHz           |
| Quality Factor @ 700 MHz, 2 V (Note 5)                       |       | 70    |       |               |
| Quality Factor @ 700 MHz, 24 V (Note 5)                      |       | 80    |       |               |
| Quality Factor @ 2.4 GHz, 2 V (Note 5)                       |       | 35    |       |               |
| Quality Factor @ 2.4 GHz, 24 V (Note 5)                      |       | 80    |       |               |
| IP3 ( $V_{bias} = 2\text{ V}$ ) (Notes 1, 3 and 5)           |       | 70    |       | dBm           |
| IP3 ( $V_{bias} = 24\text{ V}$ ) (Notes 1, 3 and 5)          |       | 85    |       | dBm           |
| 2nd Harmonic ( $V_{bias} = 2\text{ V}$ ) (Notes 2, 3 and 5)  |       | -70   |       | dBm           |
| 2nd Harmonic ( $V_{bias} = 24\text{ V}$ ) (Notes 2, 3 and 5) |       | -80   |       | dBm           |
| 3rd Harmonic ( $V_{bias} = 2\text{ V}$ ) (Notes 2, 3 and 5)  |       | -45   |       | dBm           |
| 3rd Harmonic ( $V_{bias} = 24\text{ V}$ ) (Notes 2, 3 and 5) |       | -75   |       | dBm           |
| Average Transition Time (Cmin → Cmax) (Notes 4 and 5)        |       | 66    |       | $\mu\text{s}$ |
| Average Transition Time (Cmax → Cmin) (Notes 4 and 5)        |       | 48    |       | $\mu\text{s}$ |

1.  $f_1 = 850\text{ MHz}$ ,  $f_2 = 860\text{ MHz}$ , Pin 25 dBm/Tone
2. 850 MHz, Pin +34 dBm
3. IP3 and Harmonics are measured in the shunt configuration in a 50  $\Omega$  environment
4.  $\text{RF}_{IN}$  and  $\text{RF}_{OUT}$  are both connected to DC ground
5. Sample testing only. Average Transition Time for all start and stop voltage combinations between 2 V and 24 V is 50  $\mu\text{s}$ .

# TCP-5056UB

## Representative performance data at 25°C for 5.6 pF WLCSP Package

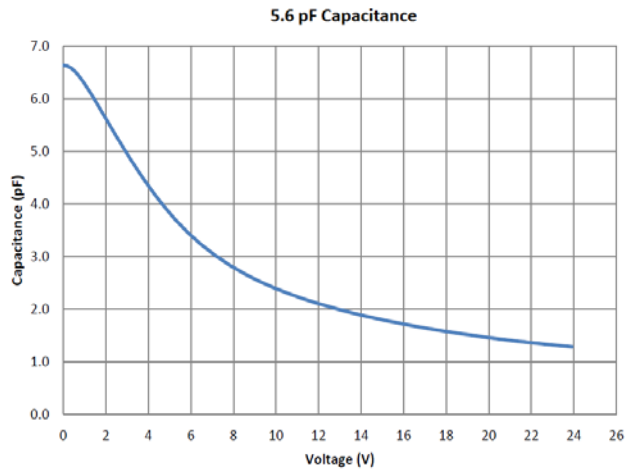

Figure 2. Capacitance

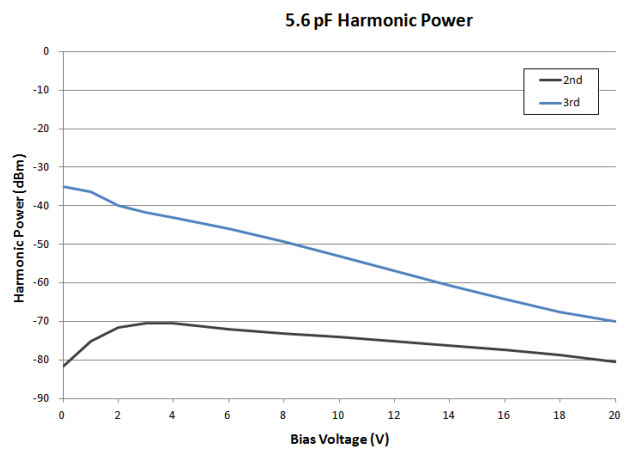

Figure 3. Harmonic Power\*

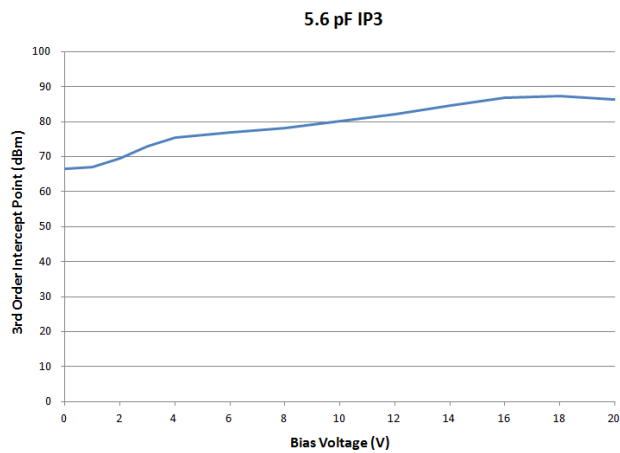

Figure 4. IP3\*

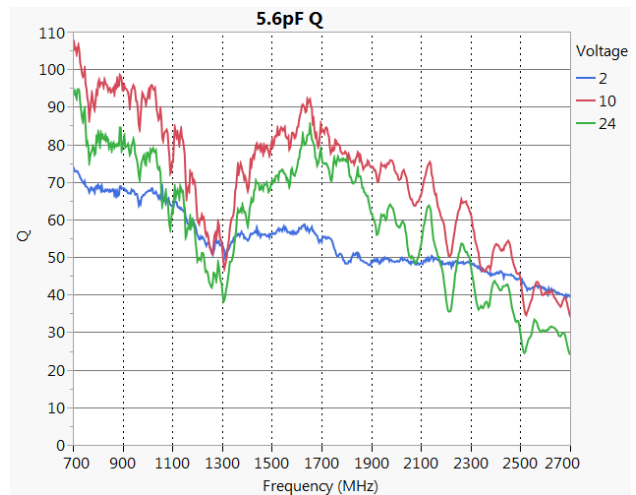

Figure 5. Q\*

\*Data shown is representative only.

Table 3. ABSOLUTE MAXIMUM RATINGS

| Parameter                   | Rating                               | Units |
|-----------------------------|--------------------------------------|-------|
| Input Power                 | +40                                  | dBm   |
| Bias Voltage                | +30 (Note 6)                         | V     |
| Operating Temperature Range | -30 to +85                           | °C    |
| Storage Temperature Range   | -55 to +125                          | °C    |
| ESD – Human Body Model      | Class 1B JEDEC HBM Standard (Note 7) |       |

Stresses exceeding those listed in the Maximum Ratings table may damage the device. If any of these limits are exceeded, device functionality should not be assumed, damage may occur and reliability may be affected.

6. WLCSP: Recommended Bias Voltage not to exceed 24 V.

7. Class 1B defined as passing 500 V, but may fail after exposure to 1000 V ESD pulse.

**ASSEMBLY CONSIDERATIONS AND REFLOW PROFILE**

The following assembly considerations should be observed:

**Cleanliness**

These chips should be handled in a clean environment.

**Electro-static Sensitivity**

ON Semiconductor’s PTICs are ESD Class 1B sensitive. The proper ESD handling procedures should be used.

**Mounting**

The WLCSP PTIC is fabricated for Flip Chip solder mounting. Connectivity to the RF and Bias terminations on the PTIC die is established through SAC305 solder balls with 90 μm nominal height (65 μm to 115 μm height variation). The PTIC die is RoHS-compliant and compatible with lead-free soldering profile.

**Molding**

The PTIC die is compatible for over-molding or under-fill.

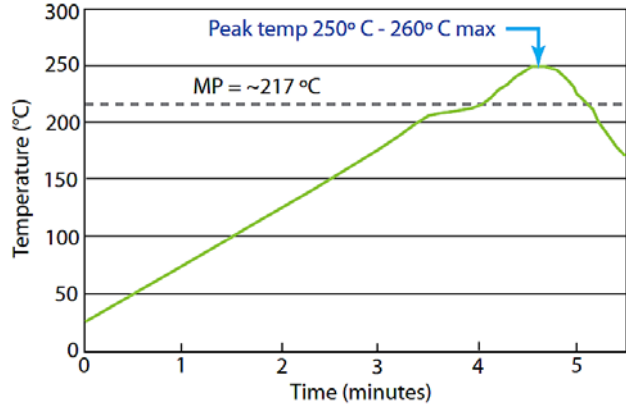

*This reflow profile is a guideline for Pb-free solder materials. Adjustments to this profile are necessary based on specific process requirements and board size, thickness and density. Not to exceed 260° C for 5 seconds.*

**Figure 6. Reflow Profile**

**ORIENTATION OF THE PTIC FOR OPTIMUM LOSSES**

When configuring the PTIC in your specific circuit design, at least one of the RF terminals must be connected to DC ground. If minimum transition times are required, DC ground on both RF terminals is recommended. To minimize losses, the PTIC should be oriented such that RF2 is at the lower RF impedance of the two RF nodes. A shunt PTIC, for example, should have RF2 connected to RF ground.

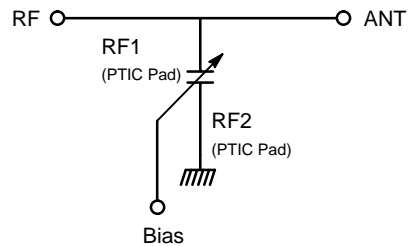

**Figure 7. PTIC Orientation Functional Block Diagram**

# TCP-5056UB

## PART NUMBER DEFINITION

**Table 4. PART NUMBERS**

| Part Number   | Capacitance |       | Marking   |            | Package*     |
|---------------|-------------|-------|-----------|------------|--------------|
|               | 2 V         | 24 V  | Device ID | Trace Code |              |
| TCP-5056UB-DT | 5.6         | 1.204 | G         | YW**       | 6-bump WLCSP |

\*See PTIC package dimensions on following page.

\*\*Refer to table below (Table 5) for YW trace code.

For information on device numbering and ordering codes, please download the *Device Nomenclature* technical note (TND310/D) from [www.onsemi.com](http://www.onsemi.com).

**Table 5. Two Digits Year and Work Week Date coding (YW) – In Process Product / Traceability Date Code Marking**

| Code | Term               | Definition  |                     |                      |      |                     |                      |      |                     |                      |
|------|--------------------|---|---------------------|----------------------|------|---------------------|----------------------|------|---------------------|----------------------|
| YW   | Year and Work Week | Two-character Alpha Code. Example: 2005, workweek 10 = GJ |                     |                      |      |                     |                      |      |                     |                      |
|      |                    | YEAR  | WORK WEEK           | CODE                 | YEAR | WORK WEEK           | CODE                 | YEAR | WORK WEEK           | CODE                 |
|      |                    | 2003  | 1<br>26<br>27<br>52 | CA<br>CZ<br>DA<br>DZ | 2004 | 1<br>26<br>27<br>52 | EA<br>EZ<br>FA<br>FZ | 2005 | 1<br>26<br>27<br>52 | GA<br>GZ<br>HA<br>HZ |
|      |                    | 2006  | 1<br>26<br>27<br>52 | IA<br>IZ<br>JA<br>JZ | 2007 | 1<br>26<br>27<br>52 | KA<br>KZ<br>LA<br>LZ | 2008 | 1<br>26<br>27<br>52 | MA<br>MZ<br>NA<br>NZ |
|      |                    | 2009  | 1<br>26<br>27<br>52 | PA<br>PZ<br>RA<br>RZ | 2010 | 1<br>26<br>27<br>52 | SA<br>SZ<br>TA<br>TZ | 2011 | 1<br>26<br>27<br>52 | UA<br>UZ<br>VA<br>VZ |
|      |                    | 2012  | 1<br>26<br>27<br>52 | WA<br>WZ<br>XA<br>XZ | 2013 | 1<br>26<br>27<br>52 | YA<br>YZ<br>ZA<br>ZZ | 2014 | 1<br>26<br>27<br>52 | AA<br>AZ<br>BA<br>BZ |
|      |                    | 2015  | 1<br>26<br>27<br>52 | CA<br>CZ<br>DA<br>DZ | 2016 | 1<br>26<br>27<br>52 | EA<br>EZ<br>FA<br>FZ | 2017 | 1<br>26<br>27<br>52 | GA<br>GZ<br>HA<br>HZ |

For dates outside of the table: the first character of the code is incremented at the start of workweek 01 and workweek 27 each year. The second character begins with “A” in workweek 01 of each year and increments weekly. “A” follows “Z” to make the code continuous.

# MECHANICAL CASE OUTLINE

## PACKAGE DIMENSIONS

ON Semiconductor®



SCALE 4:1

WLCSP6, 1.097x0.622  
CASE 567NZ  
ISSUE A

DATE 27 SEP 2016

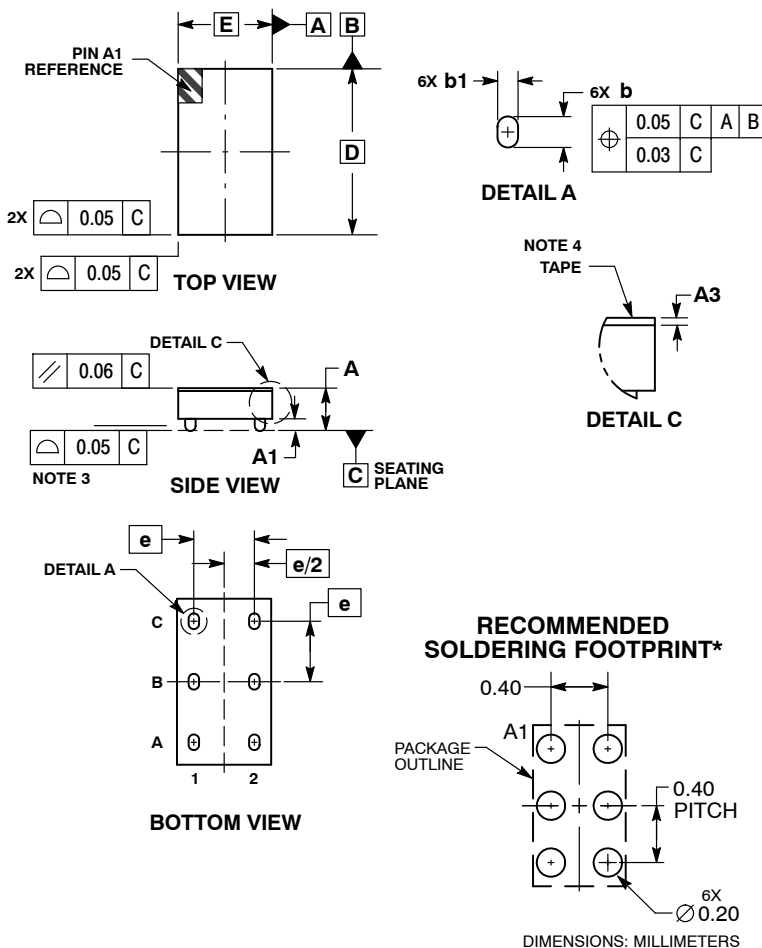

- NOTES:
1. DIMENSIONING AND TOLERANCING PER ASME Y14.5M, 1994.
  2. CONTROLLING DIMENSION: MILLIMETERS.
  3. COPLANARITY APPLIES TO SPHERICAL CROWNS OF SOLDER BALLS.
  4. BACKSIDE TAPE APPLIED TO IMPROVE PIN 1 MARKING.

| MILLIMETERS |           |       |       |
|-------------|-----------|-------|-------|
| DIM         | MIN       | NOM   | MAX   |
| A           | 0.295     | 0.335 | 0.375 |
| A1          | 0.065     | 0.090 | 0.115 |
| A3          | 0.025 REF |       |       |
| b           | 0.125     | 0.150 | 0.175 |
| b1          | 0.075     | 0.100 | 0.125 |
| D           | 1.047     | 1.097 | 1.147 |
| E           | 0.572     | 0.622 | 0.672 |
| e           | 0.40 BSC  |       |       |

### GENERIC MARKING DIAGRAM\*



- X = Specific Device Code
- Y = Year
- W = Work Week

\*This information is generic. Please refer to device data sheet for actual part marking. Pb-Free indicator, "G" or microdot "▪", may or may not be present.

\*For additional information on our Pb-Free strategy and soldering details, please download the ON Semiconductor Soldering and Mounting Techniques Reference Manual, SOLDERRM/D.

|                         |                            |  |
|-------------------------|----------------------------|--|
| <b>DOCUMENT NUMBER:</b> | <b>98AON11898G</b>         | Electronic versions are uncontrolled except when accessed directly from the Document Repository. Printed versions are uncontrolled except when stamped "CONTROLLED COPY" in red. |
| <b>DESCRIPTION:</b>     | <b>WLCSP6, 1.097X0.622</b> | <b>PAGE 1 OF 1</b>   |

ON Semiconductor and ON are trademarks of Semiconductor Components Industries, LLC dba ON Semiconductor or its subsidiaries in the United States and/or other countries. ON Semiconductor reserves the right to make changes without further notice to any products herein. ON Semiconductor makes no warranty, representation or guarantee regarding the suitability of its products for any particular purpose, nor does ON Semiconductor assume any liability arising out of the application or use of any product or circuit, and specifically disclaims any and all liability, including without limitation special, consequential or incidental damages. ON Semiconductor does not convey any license under its patent rights nor the rights of others.

ON Semiconductor and  are trademarks of Semiconductor Components Industries, LLC dba ON Semiconductor or its subsidiaries in the United States and/or other countries. ON Semiconductor owns the rights to a number of patents, trademarks, copyrights, trade secrets, and other intellectual property. A listing of ON Semiconductor's product/patent coverage may be accessed at [www.onsemi.com/site/pdf/Patent-Marking.pdf](http://www.onsemi.com/site/pdf/Patent-Marking.pdf). ON Semiconductor reserves the right to make changes without further notice to any products herein. ON Semiconductor makes no warranty, representation or guarantee regarding the suitability of its products for any particular purpose, nor does ON Semiconductor assume any liability arising out of the application or use of any product or circuit, and specifically disclaims any and all liability, including without limitation special, consequential or incidental damages. Buyer is responsible for its products and applications using ON Semiconductor products, including compliance with all laws, regulations and safety requirements or standards, regardless of any support or applications information provided by ON Semiconductor. "Typical" parameters which may be provided in ON Semiconductor data sheets and/or specifications can and do vary in different applications and actual performance may vary over time. All operating parameters, including "Typicals" must be validated for each customer application by customer's technical experts. ON Semiconductor does not convey any license under its patent rights nor the rights of others. ON Semiconductor products are not designed, intended, or authorized for use as a critical component in life support systems or any FDA Class 3 medical devices or medical devices with a same or similar classification in a foreign jurisdiction or any devices intended for implantation in the human body. Should Buyer purchase or use ON Semiconductor products for any such unintended or unauthorized application, Buyer shall indemnify and hold ON Semiconductor and its officers, employees, subsidiaries, affiliates, and distributors harmless against all claims, costs, damages, and expenses, and reasonable attorney fees arising out of, directly or indirectly, any claim of personal injury or death associated with such unintended or unauthorized use, even if such claim alleges that ON Semiconductor was negligent regarding the design or manufacture of the part. ON Semiconductor is an Equal Opportunity/Affirmative Action Employer. This literature is subject to all applicable copyright laws and is not for resale in any manner.

## PUBLICATION ORDERING INFORMATION

### LITERATURE FULFILLMENT:

Email Requests to: [orderlit@onsemi.com](mailto:orderlit@onsemi.com)

ON Semiconductor Website: [www.onsemi.com](http://www.onsemi.com)

### TECHNICAL SUPPORT

North American Technical Support:  
Voice Mail: 1 800-282-9855 Toll Free USA/Canada  
Phone: 011 421 33 790 2910

### Europe, Middle East and Africa Technical Support:

Phone: 00421 33 790 2910

For additional information, please contact your local Sales Representative