

FEATURES

- Wide operating Voltages(V1mA): form 18V to 820V.
- Fast response to transient over-voltage and limited current.
- Low Clamping ratio and no follow-on current.
- Capable of absorbing high transient energies.

APPLICATIONS

- Transistor, Diode, IC, Thyristor or Triac semiconductor protection.
- Consumer electronics.
- Industrial electronics.
- Electronic home appliances, gas and petroleum appliances.
- Relay and electromagnetic valve surge absorption.

GENERAL CHARACTERISTICS DEFINITION

- Operating Temperature: $-40^{\circ}\text{C}\sim+85^{\circ}\text{C}$.
- Storage Temperature: $-40^{\circ}\text{C}\sim+125^{\circ}\text{C}$.
- Working Surface Temperature: $+115^{\circ}\text{C}$.
- Insulation Resistance: $>100\text{M}\Omega$.

ORDERING INFORMATION

07 D 241 K
① ② ③ ④

- ① Size: 07: $\phi 7.0\text{mm}$;
- ② Type: D: Disk, S: Square;
- ③ Varistor voltage: $241\text{---}24\times 10^1=220\text{V}$;
- ④ Tolerance: K= $\pm 10\%$, L= $\pm 15\%$, M= $\pm 20\%$;

PACKAGING

Model	Component Package	Quantity
07D221K	7.0mm	1000

ELECTRICAL CHARACTERISTIC

Part Number Φ7.0mm	Maximum allowable voltage		Varistor voltage V1mA (V)	Clamping voltage (Max.)		Maximum peak current (8/20μs) Standard (A)	Maximum peak current (8/20μs) Standard (J)	Rated power (W)	Typical capacitance (Reference) @1KHz(pf)
	AC.rms (V)	DC (V)		VC (V)	IP (A)				
07D241K	150	200	240(216-264)	395	10	1200	28.0	0.25	210

DIMENSION

(unit: mm)

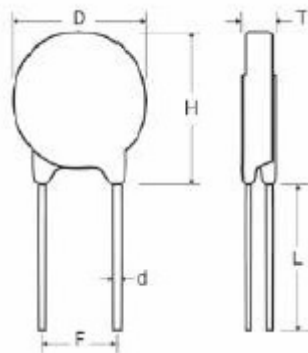

Part No.	D Max.	H Max.	L Min.	F±0.8	d±0.05	T Max.
07D241K	9.0	11.0	20.0	5.0	0.6	4.6

WAVE-SOLDERING

