

D-Sub Connectors: Right Angle, 0.406" (10.30mm) Footprint

Features:

- Two contact rows with 0.406"(10.30mm) footprint, right angle bend
- 0.109"(2.77mm) contact spacing X 0.100"(2.54mm) row spacing
- Plug and receptacle in 9, 15, 25, or 37 contact sizes
- Pin and socket contact mating design with P.C. tail termination
- Metal shell provides EMI/RFI shielding, plug shell indents provide grounding and additional mating retention
- Board mounting features include two and three prong boardlock for exceptional retention to P.C. board
- Flange mounting options for panel mount or connector mating include through hole, threaded hole and threaded standoffs
- D-shaped connector mating outline provides polarization
- Design based on requirements of MIL-C-24038, EIA RS-232 and RS-449



Specifications:

Insulator Material	Thermoplastic Polyester, UL 94V-0, Chemical Resistant, Color: Black
Contact Material	Plug (Pins): Copper Alloy Receptacle (Socket): Copper Alloy
Contact Plating	Selective Gold (See Ordering Code) over Nickel for the Mating Area, Tin Plating for Tail Area
Shell Material	Nickel Plated Steel
Current Rating	3 amps
Contact Resistance	25 Milliohms maximum
Insulation Resistance	5000 megaohms minimum
Dielectric Withstanding Voltage	1000 V AC rms at Sea Level
Operating Temperature	-55°C To +85°C (upto +125°C for high temp)
Insertion Force	16 oz (4.45 N) Maximum Per Contact Position
Withdrawal Force	1 oz (0.28 N) Minimum Per Contact Position

Ordering Code:

629-025-240-033

SERIES: _____
 629: PLUG (PIN)
 630: RECEPTACLE (SOCKET)

NO. OF CONTACTS: _____
 009 - 9 CONTACTS 025 - 25 CONTACTS
 015 - 15 CONTACTS 037 - 37 CONTACTS

CONTACT FINISH CODE: _____
 2 - GOLD FLASH PLATING
 3 - 15 MICROINCHES OF GOLD PLATING
 6 - 30 MICROINCHES OF GOLD PLATING

CONTACT CODE: _____
 40 - .406" FOOTPRINT POWER CONTACT

FLANGE MOUNTING OPTIONS:
 1 - Ø.120"(Ø3.05MM) THROUGH HOLE
 2 - #4-40 THREADED HOLE
 3 - #4-40 THREADED STANDOFF
 5 - M3 THREADED HOLE

BOARD MOUNTING FEATURE:
 1 - Ø.120"(Ø3.05MM) THROUGH HOLE
 3 - TWO PRONG BOARDLOCKS
 4 - THREE PRONG BOARDLOCKS

MATERIAL CODE:
 0 - STANDARD
 5 - HIGH TEMP INSULATOR

FLANGE MOUNTING OPTIONS

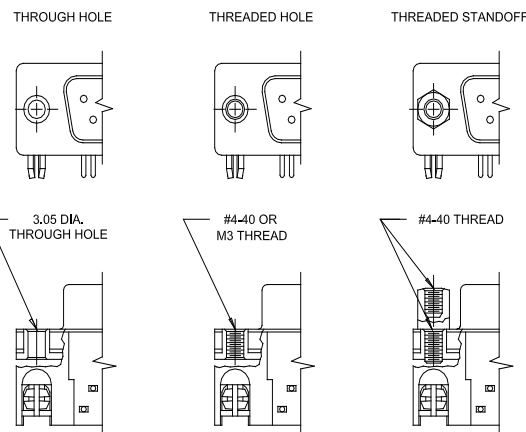

D-Sub Connectors: Right Angle, 0.406" (10.30mm) Footprint

PLUG 629 SERIES

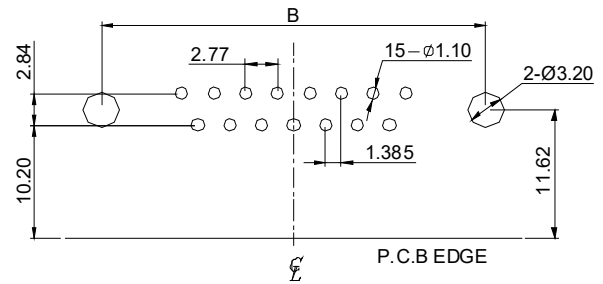
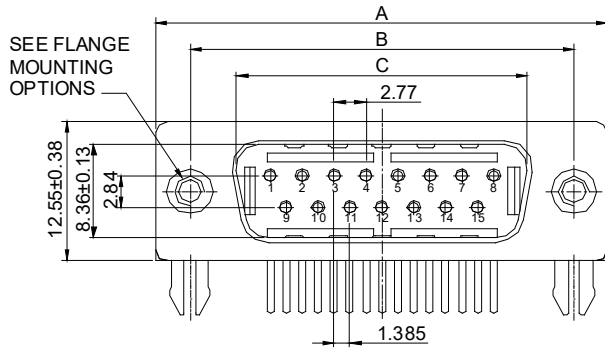

RECOMMENDED P.C.B LAYOUT
(FOR PLUG AND RECEPTACLE)

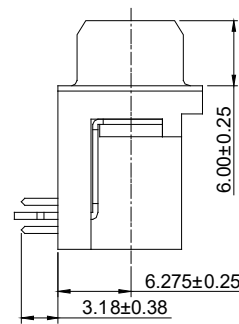
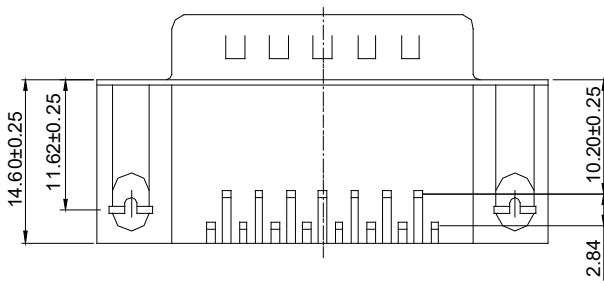

RECEPTACLE 630 SERIES

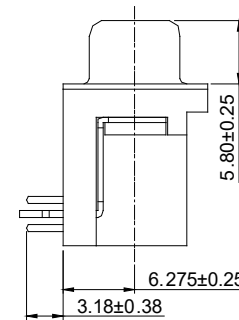
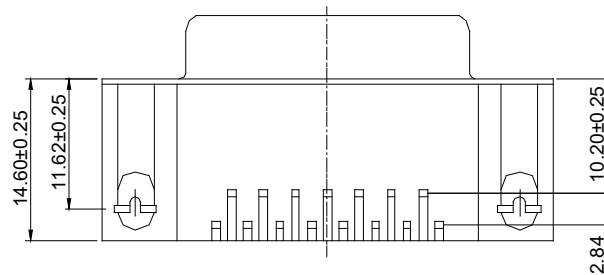
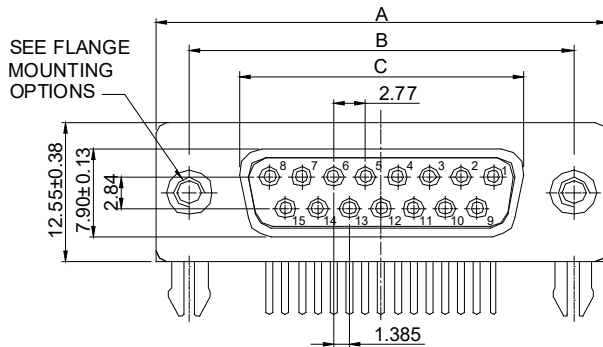

NUMBER OF CONTACTS	A±0.38		B±0.25		C±0.13 PLUG		C±0.13 RECEPTACLE	
	Inch	(mm)	Inch	(mm)	Inch	(mm)	Inch	(mm)
9	1.213	(30.81)	.984	(24.99)	.666	(16.92)	.643	(16.33)
15	1.543	(39.19)	1.312	(33.32)	.994	(25.25)	.971	(24.66)
25	2.088	(53.04)	1.852	(47.04)	1.534	(38.96)	1.511	(38.38)
37	2.729	(69.32)	2.500	(63.50)	2.182	(55.42)	2.159	(54.84)