

SCHEMATIC

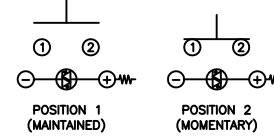

SPECIFICATIONS

FUNCTION:
1P1T OFF-(ON)

RATING:
2A 48VDC

ILLUMINATION VOLTAGE:
12V 20mA

CONTACT RESISTANCE:
Initial: 50mΩ Max. at 1A 12VDC

INSULATION RESISTANCE:
1,000MΩ Min. at 500VDC

DIELECTRIC STRENGTH:
2,000VAC Min. for 1 Minute

ELECTRICAL LIFE:
200,000 Cycles

MECHANICAL LIFE:
1,000,000 Cycles

INGRESS PROTECTION:
IP65

TEMPERATURE:
Operating: -20°C to 70°C

APPROVALS:
RoHS
COMPLIANT

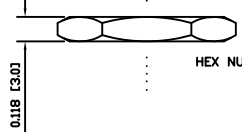
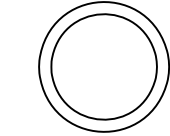
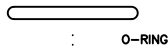
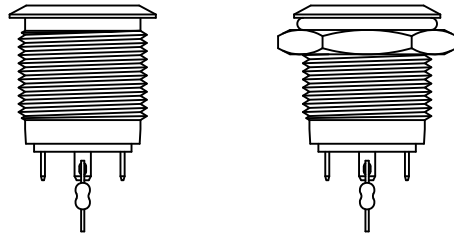
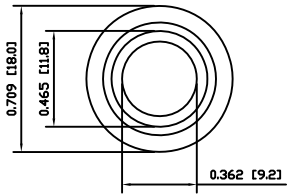

EXPLODED VIEW

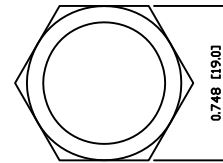

ASSEMBLED VIEW

COLORS AND FINISH

BODY:
Nickel Plated Finish

ACTUATOR:
Nickel Plated Finish

ILLUMINATION:
White (Forward)
White (Reverse)

MATERIALS

BUSHING:
Nickel Plated Brass (H62)

BASE:
Polybutylene Terephthalate (PBT), UL94 V-2

ACTUATOR:
Nickel Plated Brass (H59)
Polycarbonate (PC)

HARDWARE:
Nickel Plated Brass (H59)

SEALING:
Silicone Rubber

SPRING:
Stainless Steel (304)

CONTACTS:
Silver Alloy Plated Copper (AgCdO)

TERMINALS:
Brass (H62)

O-RING:
Silicone Rubber

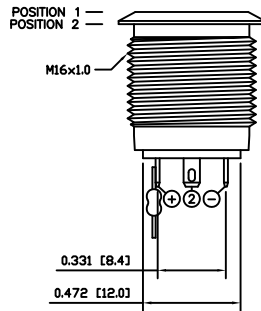
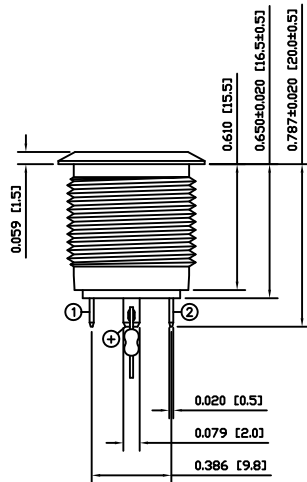

SUGGESTED PANEL CUTOUT

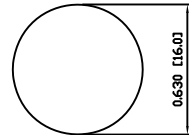

MAXIMUM PANEL THICKNESS: 0.315 [8.0mm]

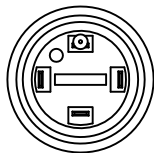

BODY	A	09/06/03	CAB
COLORS	A	09/06/03	CAB
MATERIALS	B	09/10/28	CAB
SPECIFICATIONS	A	09/06/03	CAB
REFERENCE	REV.	DATE	BY

THE INFORMATION CONTAINED IN THIS DOCUMENT IS PROPRIETARY TO E-SWITCH AND IS NOT TO BE COPIED OR TRANSFERRED

A	INITIAL RELEASE	PCRD0211	09/11/23	CAB
REV.	DESCRIPTION	PCR	DATE	DRAWN BY

DIMENSIONS	
INCHES [MILLIMETERS]	
GENERAL TOLERANCES	
±0.008 [±0.2] / ±1'	
SCALE	PROJECTION
DRAWING NOT TO SCALE	1st Angle

PV6F240NN-304		
DRAWING NUMBER	DATE	REVISION
52-PV6F240NN304	NOVEMBER 23, 2009	A