

Technical Data Sheet

204-10ASUBW/S400-A5

Features

- Popular T-1 3/4 diameter package.
- Choice of various viewing angles.
- Available on tape and reel.
- Reliable and robust.
- Pb free .
- The product remain within RoHS compliant version.
- ESD-withstand voltage: up to 5KV

Descriptions

- The series is specially designed for Applications requiring higher Brightness
- The LED lamps are available with Different colors,intensities,epoxy colors,etc.

Applications

- TVset
- Monitor
- Telephone
- Computer

Device Selection Guide

Chip		Lens Color
Material	Emitted Color	
InGaN	Super Blue	White Diffused

204-10ASUBW/S400-A5

Package Dimensions

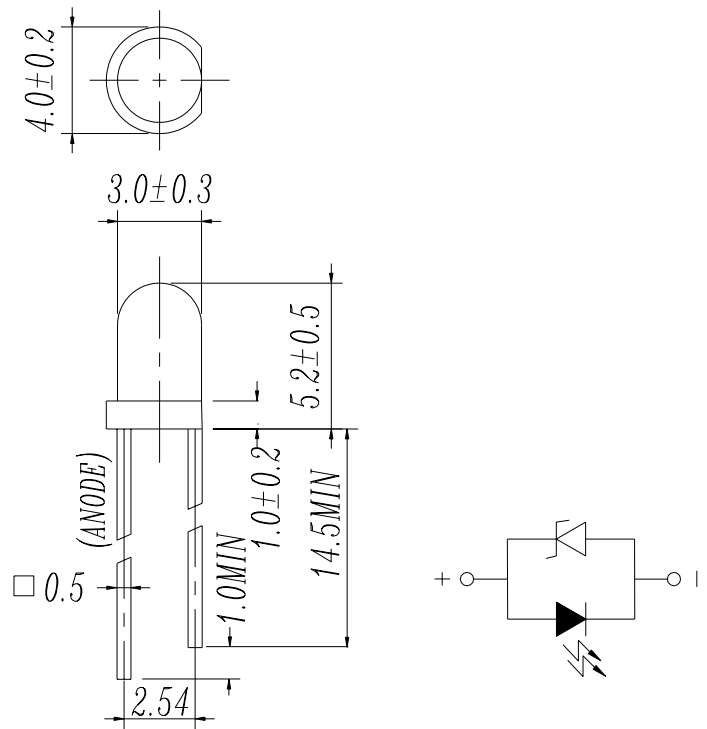

Notes:

- All dimensions are in millimeters, tolerance is 0.25mm except being specified.
- Lead spacing is measured where the lead emerges from the package.
- Protruded resin under flange is 1.5mm Max LED.

Absolute Maximum Ratings ($T_a=25^\circ\text{C}$)

Parameter	Symbol	Rating	Units
Forward Current	I_F	30	mA
Operating Temperature	T_{opr}	-40 ~ +85	$^\circ\text{C}$
Storage Temperature	T_{stg}	-40 ~ +100	$^\circ\text{C}$
Soldering Temperature	T_{sol}	260 \pm 5	$^\circ\text{C}$
Power Dissipation	P_d	110	mW
Reverse Voltage	V_R	5	V
Zener Reverse Current	I_Z	100	mA
Electrostatic Discharge	ESD	5000	V

Notes: Soldering time \leq 5 seconds.

204-10ASUBW/S400-A5

Electro-Optical Characteristics (Ta=25°C)

Parameter	Symbol	*Chip Rank	Min.	Typ.	Max.	Unit	Condition
Luminous Intensity	I_V	-----	160	320	-----	mcd	$I_F=20mA$
Viewing Angle	$2\theta 1/2$	-----	-----	30	-----	deg	
Peak Wavelength	λ_p	-----	-----	468	-----	nm	
Dominant Wavelength	λ_d	-----	-----	470	-----		
Spectrum Radiation Bandwidth	$\Delta\lambda$	-----	-----	35	-----		
Forward Voltage	V_F	-----	-----	3.4	4.0	V	
Zener Reverse Voltage	V_Z	-----	-----	-----	3.0	V	$I_Z=5mA$

204-10ASUBW/S400-A5

Typical Electro-Optical Characteristics Curves

SUB

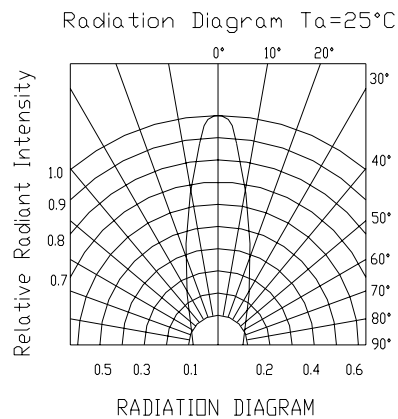
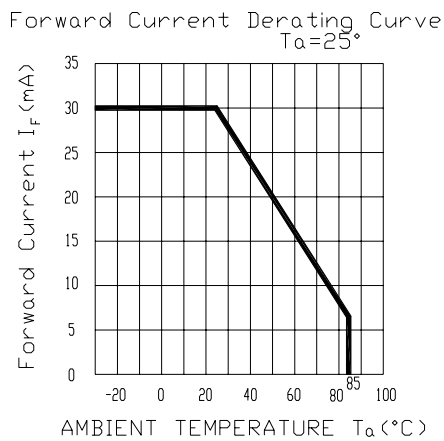
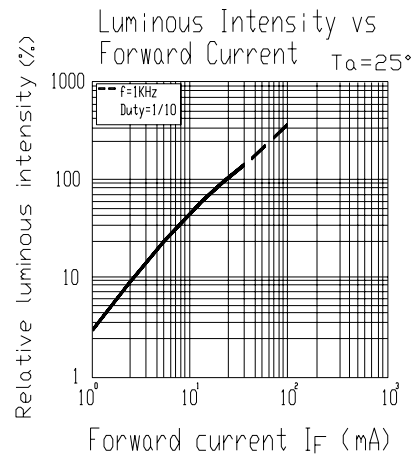
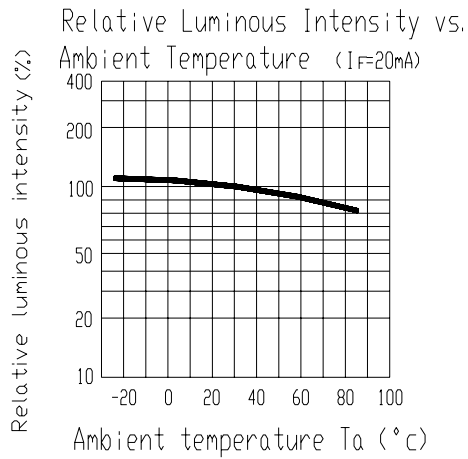
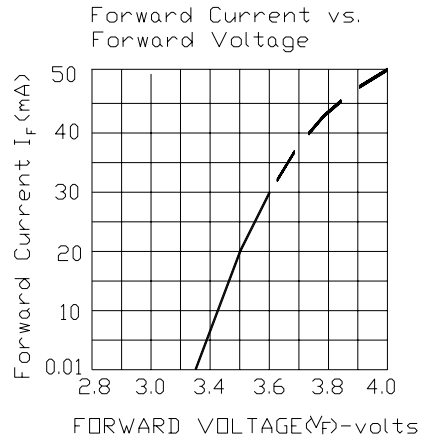
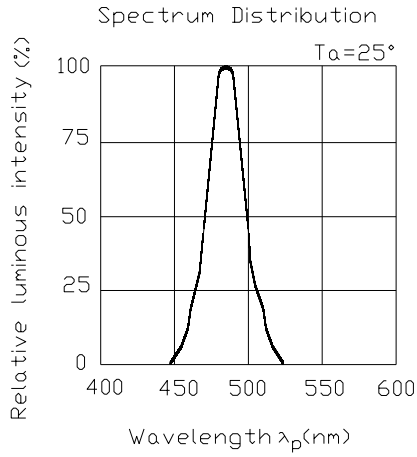

204-10ASUBW/S400-A5

Reliability Test Items And Conditions

The reliability of products shall be satisfied with items listed below.

Confidence level : 97%

LTPD : 3%

NO	Item	Test Conditions	Test Hours/Cycle	Sample Size	Failure Judgment Criteria	Ac/Re
1	Solder Heat	TEMP : 260°C ± 5 °C	10 SEC	76 PCS	Iv ≤ Ivt*0.5 or Vf ≥ U or Vf ≤ L	0/1
2	Temperature Cycle	H : +100°C 15min ∫ 5 min L : -40°C 15min	300 CYCLES	76 PCS		0/1
3	Thermal Shock	H : +100°C 5min ∫ 10sec L : -10°C 5min	300 CYCLES	76 PCS		0/1
4	High Temperature Storage	TEMP : 100°C	1000 HRS	76 PCS		0/1
5	Low Temperature Storage	TEMP : -40°C	1000 HRS	76 PCS		0/1
6	DC Operating Life	TEMP : 25°C IF = 20mA	1000 HRS	76 PCS		0/1
7	High Temperature / High Humidity	85°C / 85% RH	1000 HRS	76 PCS		0/1

Note : Ivt : The test Iv value of the chip before the reliability test

Iv : The test value of the chip that has completed the reliability test

U : Upper Specification Limit

204-10ASUBW/S400-A5

Label Form Specification

EVERLIGHT	
CPN:	
P/N:	
204-10ASUBW/S400-A5	
QTY :	CAT:
204-10ASUBW/S400-A5	
LOT NO :	HUE:
204-10ASUBW/S400-A5	
MADE IN TAIWAN	

CPN: Customer's Production Number
P/N : Production Number
204-10ASUBW/S400-A5: Production name
QTY: Packing Quantity
CAT: Ranks of Luminous and Forward Voltage
HUE: Ranks of Dominant Wavelength
REF: Reference
LOT No: Lot Number
MADE IN TAIWAN: Production Place

Notes

1. Above specification may be changed without notice. EVERLIGHT will reserve authority on material change for above specification.
2. When using this product, please observe the absolute maximum ratings and the instructions for using outlined in these specification sheets. EVERLIGHT assumes no responsibility for any damage resulting from use of the product which does not comply with the absolute maximum ratings and the instructions included in these specification sheets.
3. These specification sheets include materials protected under copyright of EVERLIGHT corporation. Please don't reproduce or cause anyone to reproduce them without EVERLIGHT's consent.
4. When the LED is connected using serial circuit, if either piece of LED is no light up but current can't flow through causing others to light down. In new design, the LED is parallel with zener diode. if either piece of LED is no light up but current can flow through causing others to light up

