

## IGBT MODULE ( L series)

### ■ Features

- High Speed Switching
- Low Saturation Voltage
- Voltage Drive
- Isolated Package

### ■ Applications

- Ideal for Chopper Application
- AC and DC Servo Drive Supply
- Uninterruptible Power Supply
- Industrial Machines, such as Welding Machines

### ■ Maximum Ratings and Characteristics

#### ● Absolute Maximum Ratings

Items	Symbols	Ratings	Units
Collector-Emitter Voltage	V <sub>CES</sub>	600	V
Gate-Emitter Voltage	V <sub>GES</sub>	±20	V
Collector Current	Continuous	I <sub>C</sub>	75
	1ms	I <sub>C pulse</sub>	150
Max. Power Dissipation	P <sub>C</sub>	300	W
Operating Temperature	T <sub>j</sub>	+150	°C
Storage Temperature	T <sub>stg</sub>	-40 to +125	°C
Isolation Voltage	AC. 1min.	V <sub>is</sub>	2500
Screw Torque	Mounting *1	1.7	N•m
	Terminals *1	1.7	

#### ● Electrical Characteristics (T<sub>j</sub>=25°C unless otherwise specified)

Items	Symbols	Test Conditions	Min.	Typ.	Max.	Units
Zero Gate Voltage Collector Current	I <sub>CES</sub>	V <sub>GE</sub> =0V V <sub>CE</sub> =600V T <sub>c</sub> =25°C			1.0	mA
Gate-Emitter Leakage Current	I <sub>GES</sub>	V <sub>CE</sub> =0V V <sub>GE</sub> =±20V			100	nA
Gate-Emitter Threshold Voltage	V <sub>GE(th)</sub>	V <sub>CE</sub> =20V I <sub>C</sub> =75mA	3.0		6.0	V
Collector-Emitter Saturation Voltage	V <sub>CE(sat)</sub>	V <sub>GE</sub> =15V I <sub>C</sub> =75A		2.7	3.5	V
Input Capacitance	C <sub>ies</sub>	V <sub>GE</sub> =0V		7100		pF
Output Capacitance	C <sub>oes</sub>	V <sub>CE</sub> =10V		-		
Reverse Transfer Capacitance	C <sub>res</sub>	f=1MHz		-		
Turn-on Time	t <sub>on</sub>	V <sub>CC</sub> =300V		0.4	0.8	μs
	t <sub>r</sub>	I <sub>C</sub> =75A		0.3	0.6	
Turn-off Time	t <sub>off</sub>	V <sub>GE</sub> =±15V		0.6	1.0	
	t <sub>f</sub>	R <sub>G</sub> =33Ω		0.2	0.35	

t<sub>on</sub>, t<sub>r</sub>: Resistive Load    t<sub>off</sub>, t<sub>f</sub>: Inductive Load

#### ● Thermal Characteristics

Items	Symbols	Test Conditions	Min.	Typ.	Max.	Units
Thermal Resistance	R <sub>th(j-c)</sub>	IGBT			0.417	°C/W
	R <sub>th(c-f)</sub>	With Thermal compound		0.06		

### ■ Outline Drawings

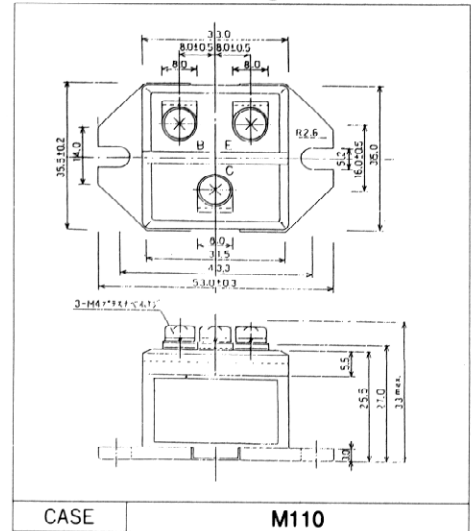

### ■ Equivalent Circuit Schematic

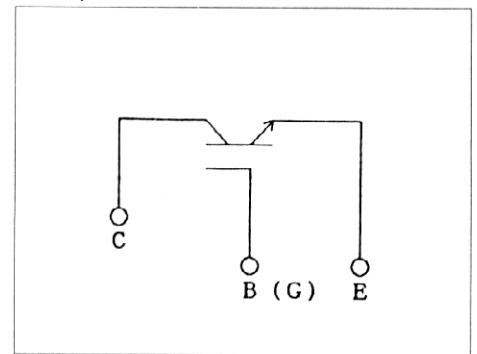

\*1 Recommendable Value 1.3 ~ 1.7 N•m (M4)

## Characteristics

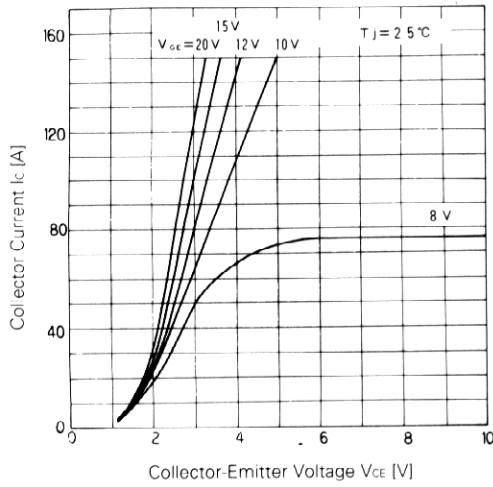

Collector Current vs. Collector-Emitter Voltage

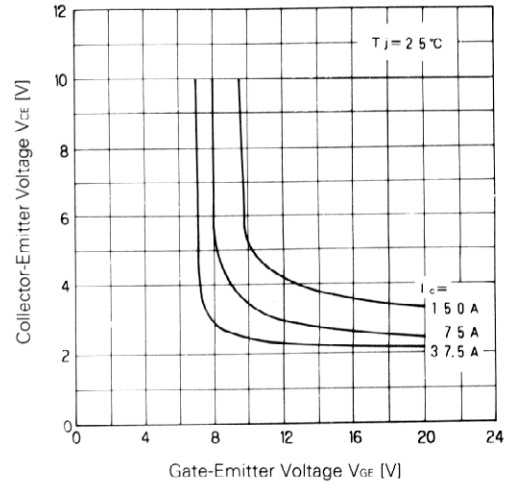

Collector-Emitter Voltage vs. Gate-Emitter Voltage

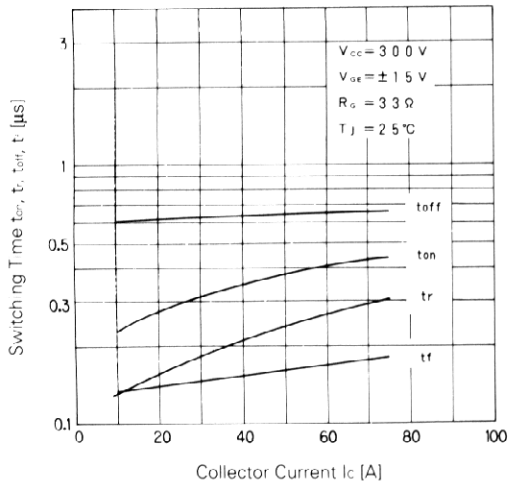

Switching Time

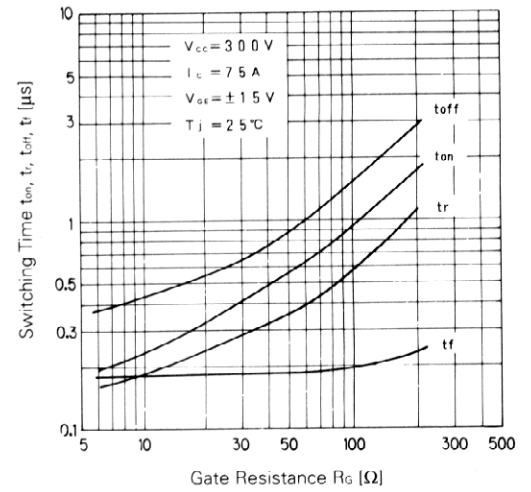

Switching Time-Gate Resistance

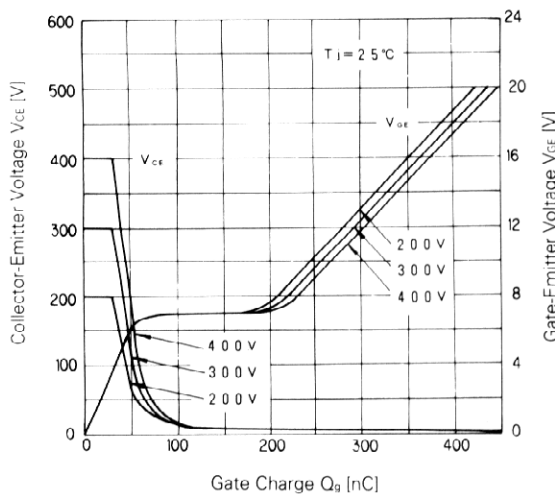

Dynamic Input Characteristic

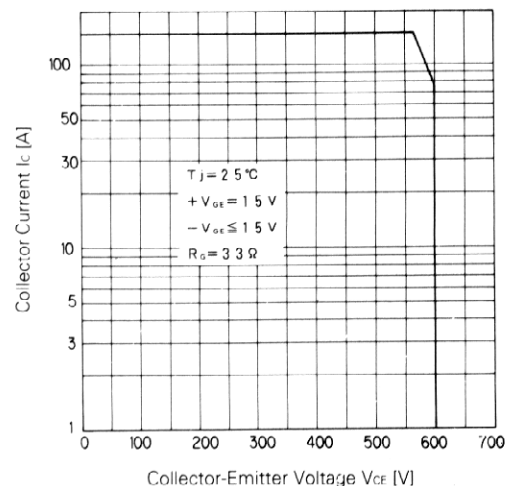

Reverse Biased Safe Operating Area

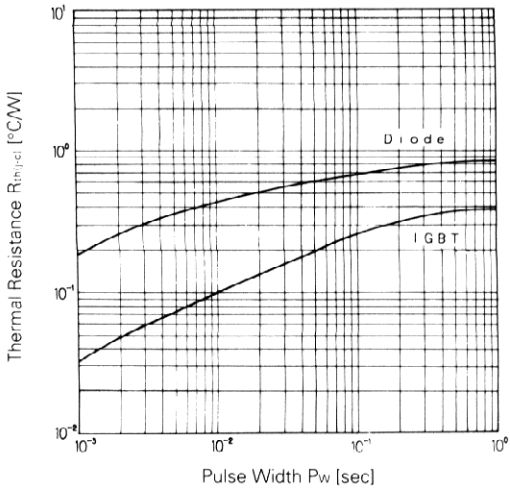

Transient Thermal Resistance

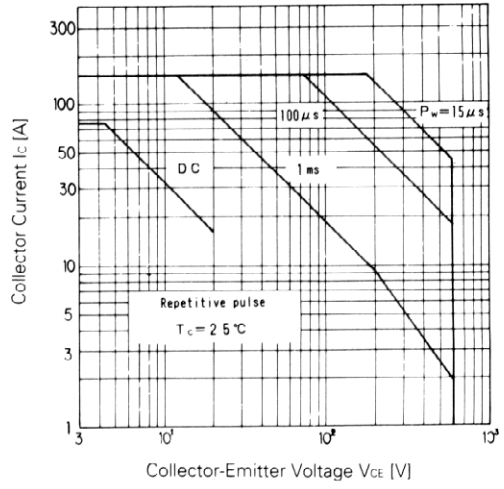

Safe Operating Area