

# SST-06-IRD-810nm

## Dual Junction Surface Mount Series

### Infrared LED

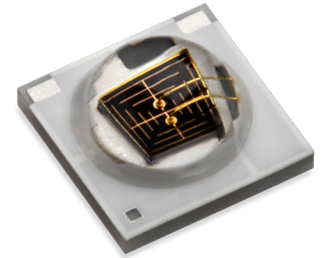

#### Table of Contents

Technology Overview . . . . .	2
Product Binning . . . . .	3
Ordering Information . . . . .	3
Optical and Electrical Characteristics . . . . .	4
Mechanical Dimensions . . . . .	8
Tape and Reel . . . . .	9
Reel Information . . . . .	10
Shipping information . . . . .	11
Soldering . . . . .	12
Precautions . . . . .	13
Revision History . . . . .	14

#### Features

---

- High Power Infrared LED with typical 810nm centroid wavelength
- 80-degree viewing angle
- Operation at up to 1.0A CW and 2A pulse
- Built-in ESD protection
- Low Thermal Resistance
- Suitable for all SMT Assembly Methods
- RoHS and REACH compliant

#### Applications

---

- Surveillance Systems / CCTV
- Iris and Face Recognition
- License Plate Scanning
- Automotive Sensing
- Machine Vision
- Night Vision

## Technology Overview

Luminus SST-06-IRD-810nm LEDs benefit from innovations in device technology, chip packaging and thermal management. This suite of technologies give engineers and system designers the freedom to develop solutions both high in power and efficiency.

### Reliability

Luminus SST-06-IRD-810nm LEDs have passed a rigorous suite of environmental and mechanical stress tests, including mechanical shock, vibration, temperature cycling and humidity. They are fully qualified for use in a wide range of high performance and high efficacy applications.

### REACH & RoHS Compliance

The Luminus SST-06-IRD-810nm LED is compliant to the Restriction of Hazardous Substances Directive or RoHS. The restricted materials including lead, mercury cadmium hexavalent chromium, polybrominated biphenyls (PBB) and polybrominated diphenyl ether (PBDE) are not used.

## Understanding Luminus SST-06-IRD-810nm LED Test Specifications

Every Luminus LED is fully tested to ensure it meets the high quality standards customers have come to expect from Luminus products.

### Testing Temperature

Luminus SST-06-IRD-810nm LEDs are tested and binned at 25°C junction temperature. Temperature curves are provided to allow users to scale the data for actual operating temperature conditions.

## Product Ordering and Shipping Part Number Nomenclature

All SST-06-IRD-810nm products are packaged and labeled with part numbers as outlined in below. When shipped, each reel will contain only a single flux wavelength and Vf bin. The part number designation is as follows:

Products	Ordering Part Number	Description
SST-06-IRD	SST-06-IRD-B##-F###	SST-10 dual junction surface mount infrared LED

SST    —    06    —    CC    —    B##    —    F###

Product Family	Chip Area	Color	Package Configuration	Bin Kit <sup>1,2</sup>
SST - Ceramic Surface Mount package w/ encapsulation	06: 0.6 mm <sup>2</sup>	IRD = Dual Junction Infrared	B80 - 80 deg Beam Angle Ceramic 3.45mm x 3.45mm See Page 8 or Detailed Drawing	See below for flux and wavelength binning information

Peak Wavelength	Minimum Flux Bin (mW)	Lens Angle	Ordering Part Number
810	415	90	<i>SST-06-IRD-B80-Q810</i>

### Flux Bins<sup>1</sup>

Bin Code	Radiometric Power at 350mA, t <sub>p</sub> =20ms	
	Minimum Flux (mW)	Maximum Flux (mW)
Q	415	445
R	445	475
S	475	505
T	505	535

### Wavelength Bins<sup>1</sup>

Bin Code	Minimum Peak Wavelength (nm)	Maximum Peak Wavelength (nm)
810	800	830

## Optical and Electrical Characteristics

### Optical and Electrical Characteristics<sup>1</sup>

Parameter	Symbol	Package Type	Unit
		B80	
Forward Current	$I_f$	350	mA
Output Power Typical	$PO$	475	mW
Output Power at 1.0A, $t_r=20ms$ (typ.)	$PO_{1.0A}$	1300	mW
Radiant Intensity at 1.0A, $t_r=20ms$ (typ.)	$\phi_e$	680	mW/sr
Minimum Forward Voltage <sup>1</sup>	$V_{fmin}$	2.8	V
Forward Voltage Typical	$V_f$	3.0	V
Maximum Forward Voltage <sup>1</sup>	$V_{fmax}$	3.4	V
Viewing Angle	$2\theta_{1/2}$	90	deg
Peak Wavelength Typical	$\lambda_p$	815	nm
Centroid Wavelength Typical	$\lambda_c$	810	nm
FWHM Typical	$\Delta\lambda_{1/2}$	30	nm
Temperature Coefficient of Forward voltage	$TC_{V_f}$	-3.0	mV/°C
Temperature Coefficient of Radiometric Power	$TC_{PO}$	-0.2	%/°C
Temperature Coefficient of Wavelength	$TC_{\lambda}$	0.3	nm/°C
Thermal Resistance (Electrical)	$R_{TH}$	8.2	°C/W

Note 1: Binning based on operation at a current of 350mA, 20ms single pulse and a constant junction temperature of  $T_j = 25^\circ\text{C}$ . Parts are binned and shipped in 0.2V Vf increments.

## Optical and Electrical Characteristics

### Absolute Maximum Ratings<sup>2</sup>

Parameter	Symbol	Rating	Unit
Forward Current <sup>3,4</sup>	I	1.0	A
Power Dissipation	P <sub>D</sub>	4	W
Reverse Voltage	V <sub>R</sub>	5	V
Storage Temperature	T <sub>STG</sub>	-40~100	°C
Junction Temperature <sup>3,4</sup>	T <sub>J</sub>	115 °C	°C
Soldering Temperature	T <sub>SLD</sub>	JEDEC 020 , 260 °C	
ESD Sensitivity (HBM)	V <sub>B</sub>	6000	V

Note 2: To prevent damage refer to operating conditions and derating curves for appropriate maximum operating conditions

Note 3: Luminus SST-06-IRD-810nm LEDs are designed for operation up to an absolute maximum forward drive current as specified above. Product lifetime data is specified at typical forward drive currents. Sustained operation at absolute maximum currents will result in a reduction of device lifetime compared to typical forward drive currents. Actual device lifetimes will also depend on junction temperature.

Note 4: Maximum operating case temperature combined with maximum drive current defines the total maximum operating condition for the device. To prevent damage, please operate devices within specified conditions.

Note 5: Caution must be taken not to stare at the light emitted from these LEDs. Under special circumstances, the high intensity could damage the eye.

## Optical and Electrical Characteristics

### Relative Output Flux vs. Forward Current

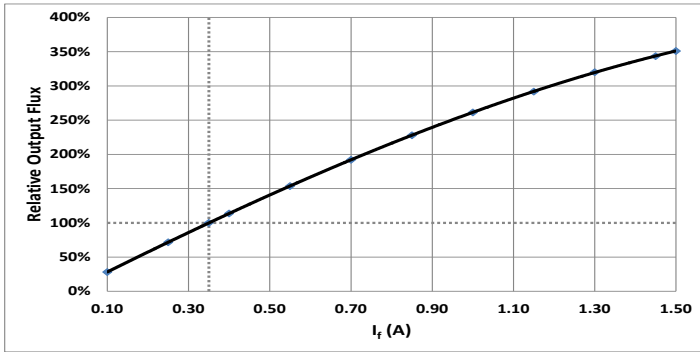

### Relative Output Flux vs. Temperature

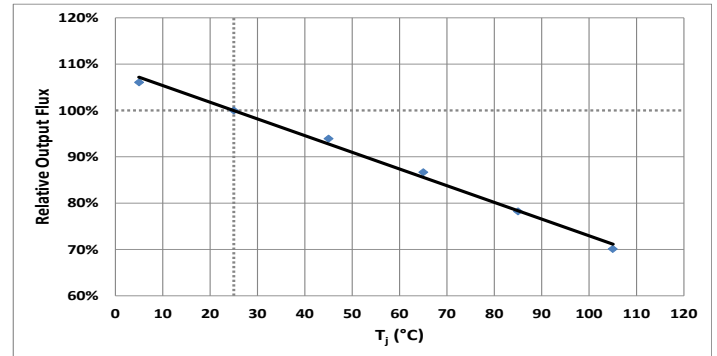

### Relative Forward Voltage vs. Forward Current

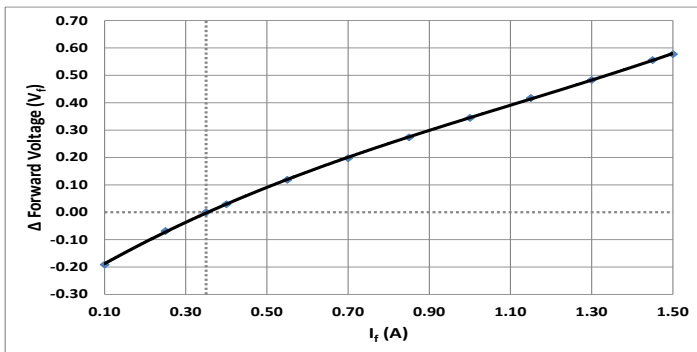

### Relative Forward Voltage vs. Temperature

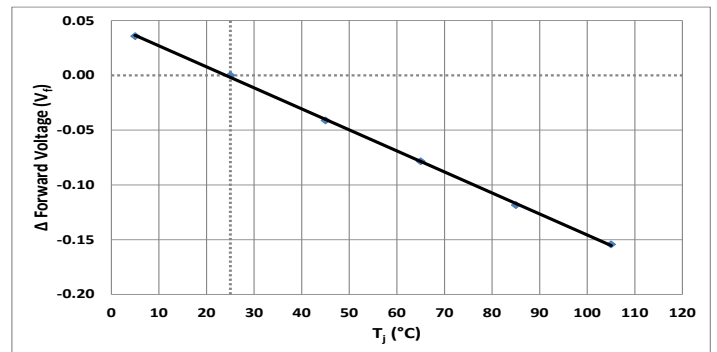

### Relative Peak Wavelength vs. Forward Current

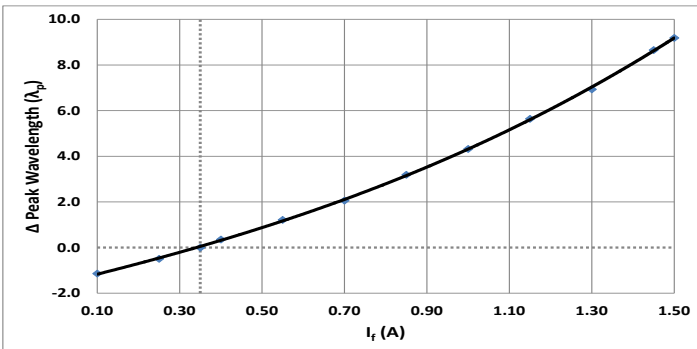

### Relative Peak Wavelength vs. Temperature

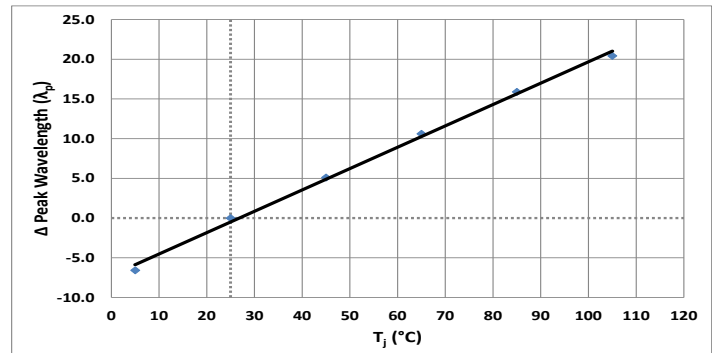

## Optical and Electrical Characteristics

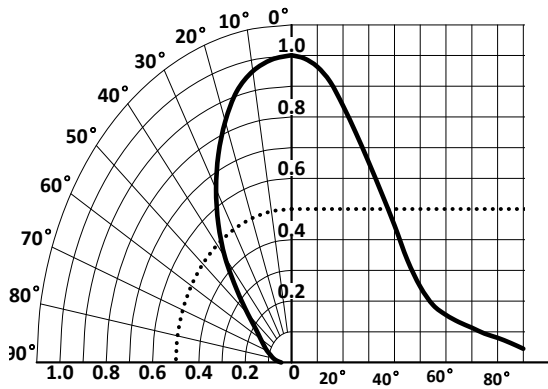
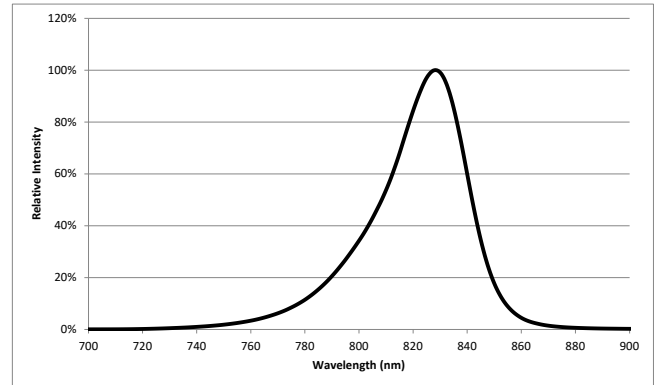
**Typical Polar Radiation Plot - B80**

**Typical Spectrum**

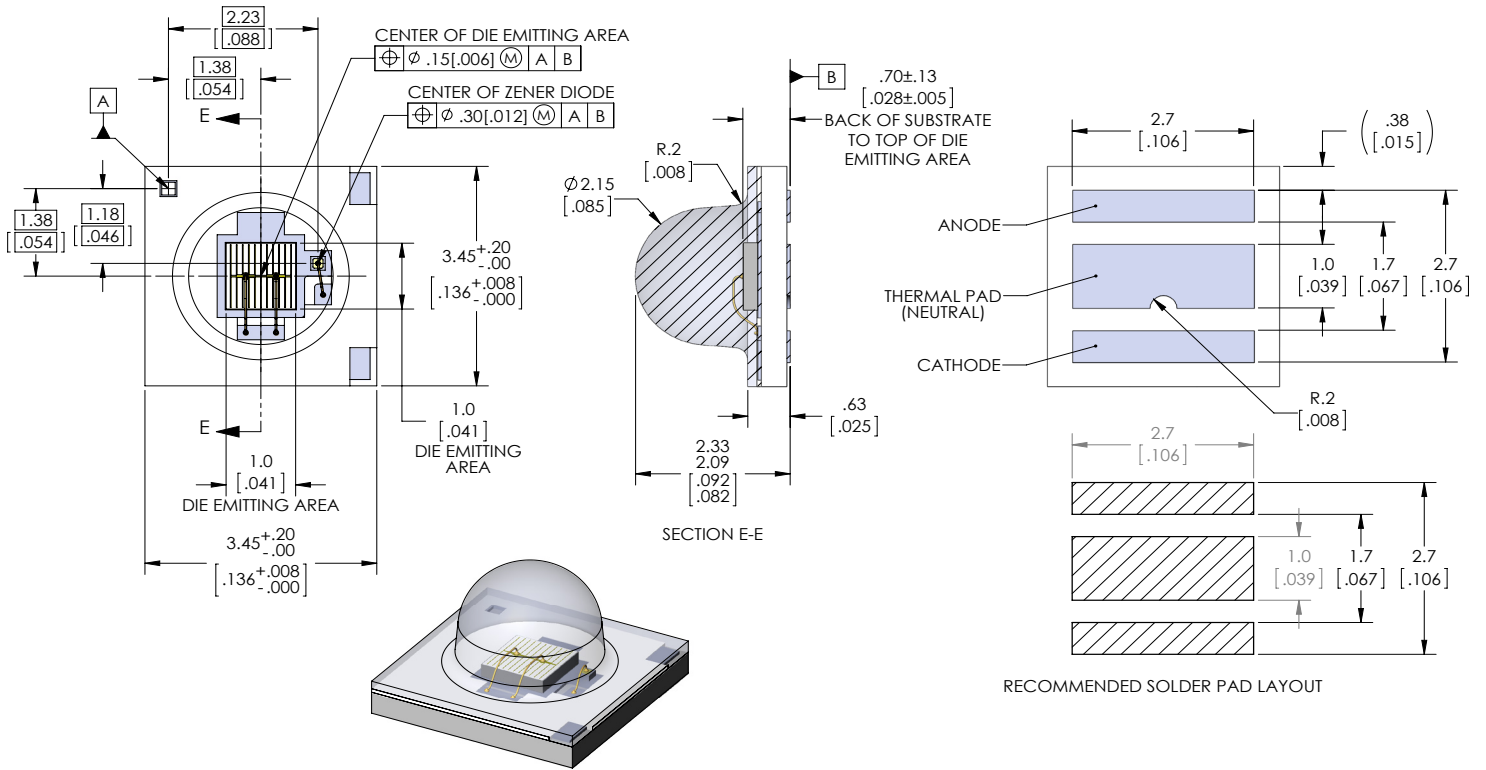
### Mechanical Dimensions - B80 Package



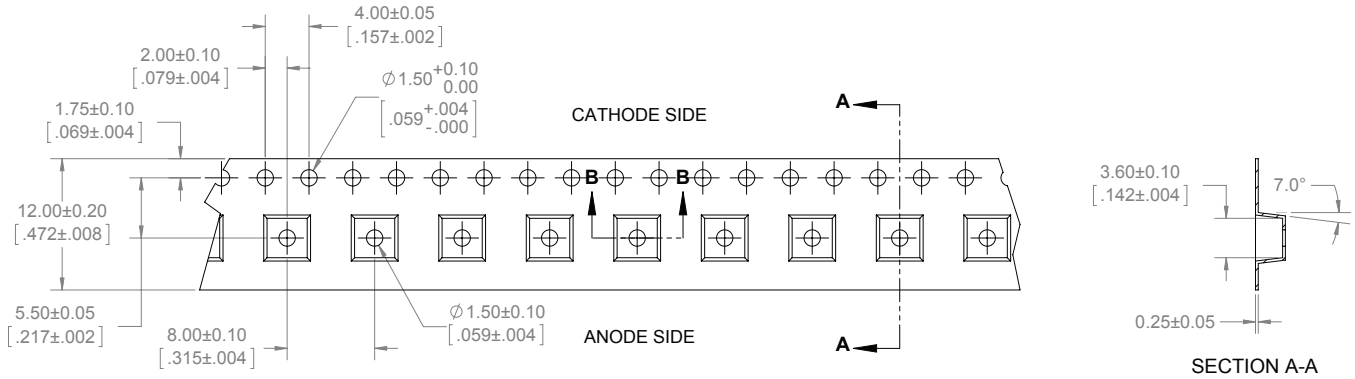

### Tape and Reel - B80 Package

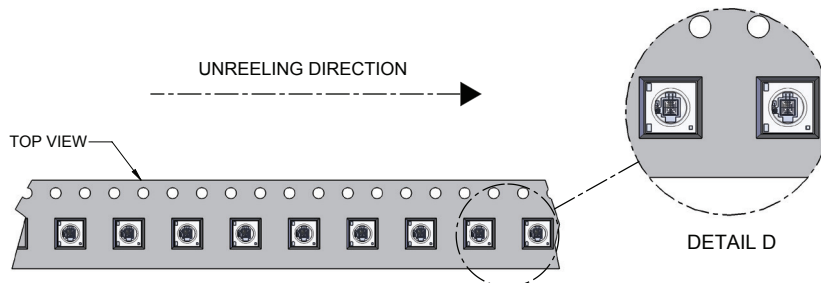
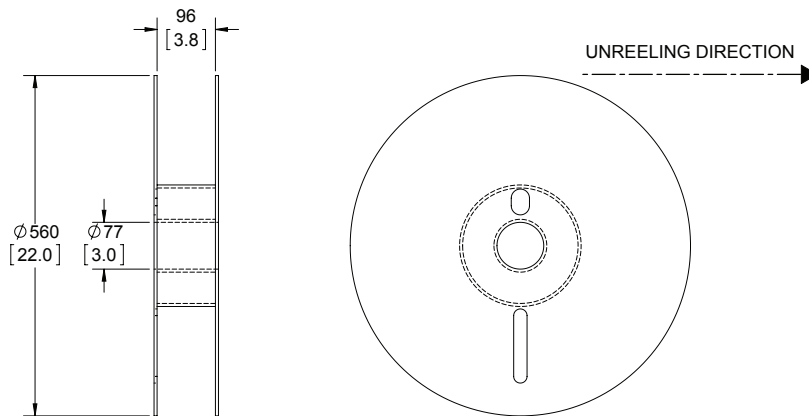

**NOTES:**

1. FINAL TAPE AND REEL PACKAGING MUST MEET THE REQUIREMENTS OF JEDEC-STD-033, LEVEL 2A.
2. LEAVE 304.8mm [12.00 in] OF TAPE EMPTY FOR LEAD IN (38 EMPTY POCKETS).
3. LEAVE 457.2mm [18.00 in] OF TAPE EMPTY FOR TRAILER (57 EMPTY POCKETS).
4. MUST COMPLY TO EIA-481-C-2003

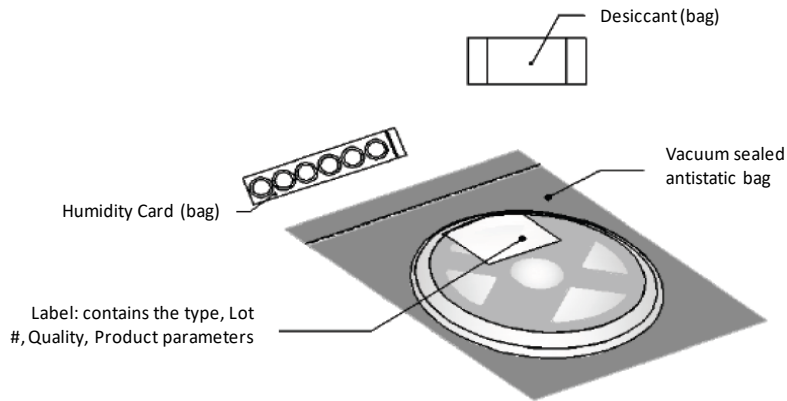

## Reel Packaging

**500 parts per reel for B50/B90 Packages - 1,000 parts per rel for B130 Package**



## Reel Label

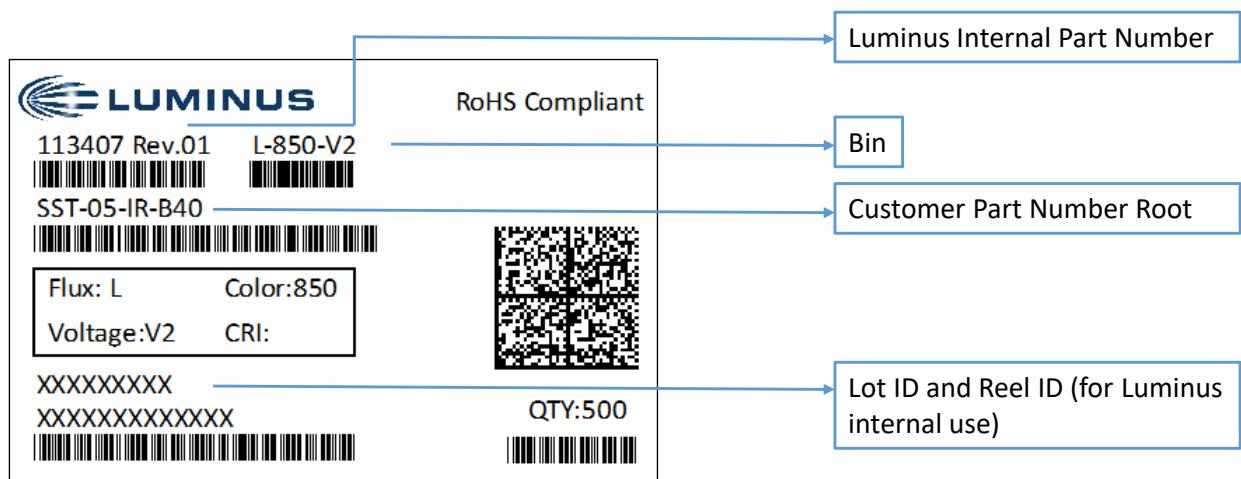

### Shipping Label

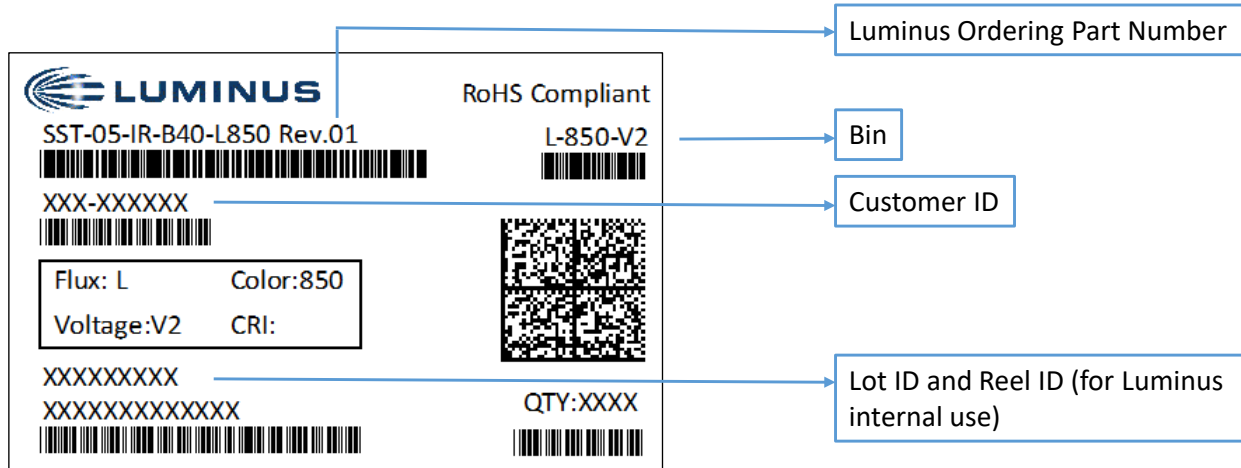

### Box Packaging Information

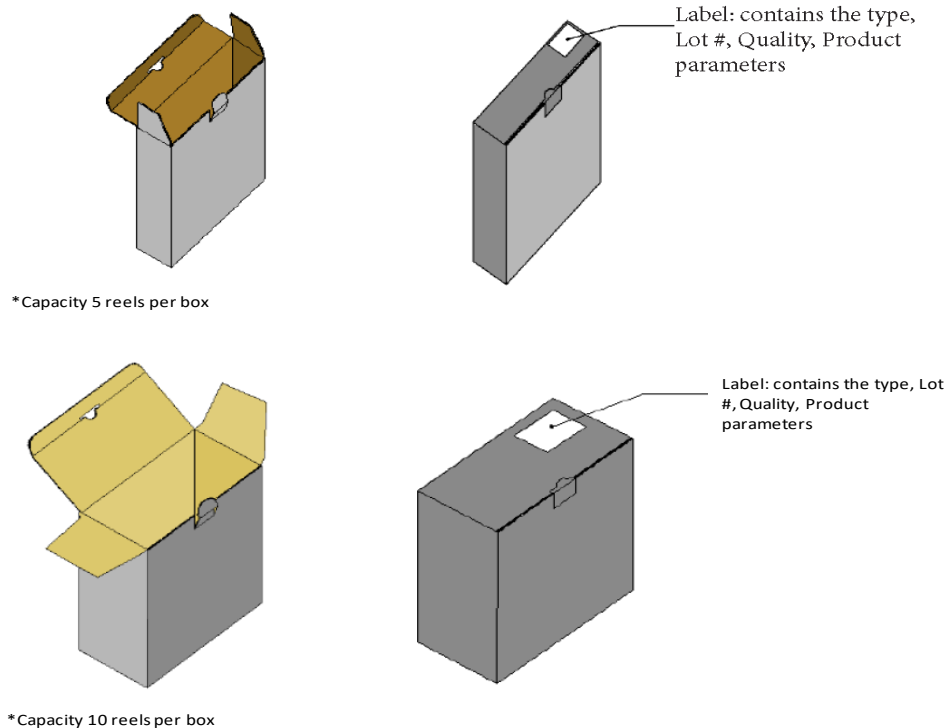

### Soldering Profile

Profile Feature	Sn-Pb Eutectic Assembly	Pb-Free Assembly
Preheat & Soak	100 °C	150 °C
Temperature min (T <sub>smin</sub> )	150 °C	200 °C
Temperature max (T <sub>smax</sub> )	60-120 seconds	60-120 seconds
Time (T <sub>smin</sub> to T <sub>smax</sub> ) (t <sub>s</sub> )		
Average ramp-up rate (T <sub>smax</sub> to T <sub>p</sub> )	3 °C/second max	3 °C/second max
Liquidous temperature (T <sub>L</sub> )	183 °C	217 °C
Time at liquidous (t <sub>L</sub> )	60-150 seconds	60-150 seconds
Peak package body temperature (T <sub>p</sub> )*	230 °C ~235 °C	255 °C ~260 °C
Classification temperature (T <sub>c</sub> )	235 °C	260 °C
Time (t <sub>p</sub> ) within 5 °C of the specified classification temperature (T <sub>c</sub> )	20 seconds	30 seconds
Average ramp-down rate (T <sub>p</sub> to T <sub>smax</sub> )	6 °C/second max	6 °C/second max
Time 25 °C to peak temperature	6 minutes max	8 minutes max

\* Tolerance for peak profile temperature(T<sub>p</sub>) is defined as a supplier minimum and a user maximum.

\*\* Tolerance for time at peak profile temperature(t<sub>p</sub>) is defined as a supplier minimum and a user maximum.

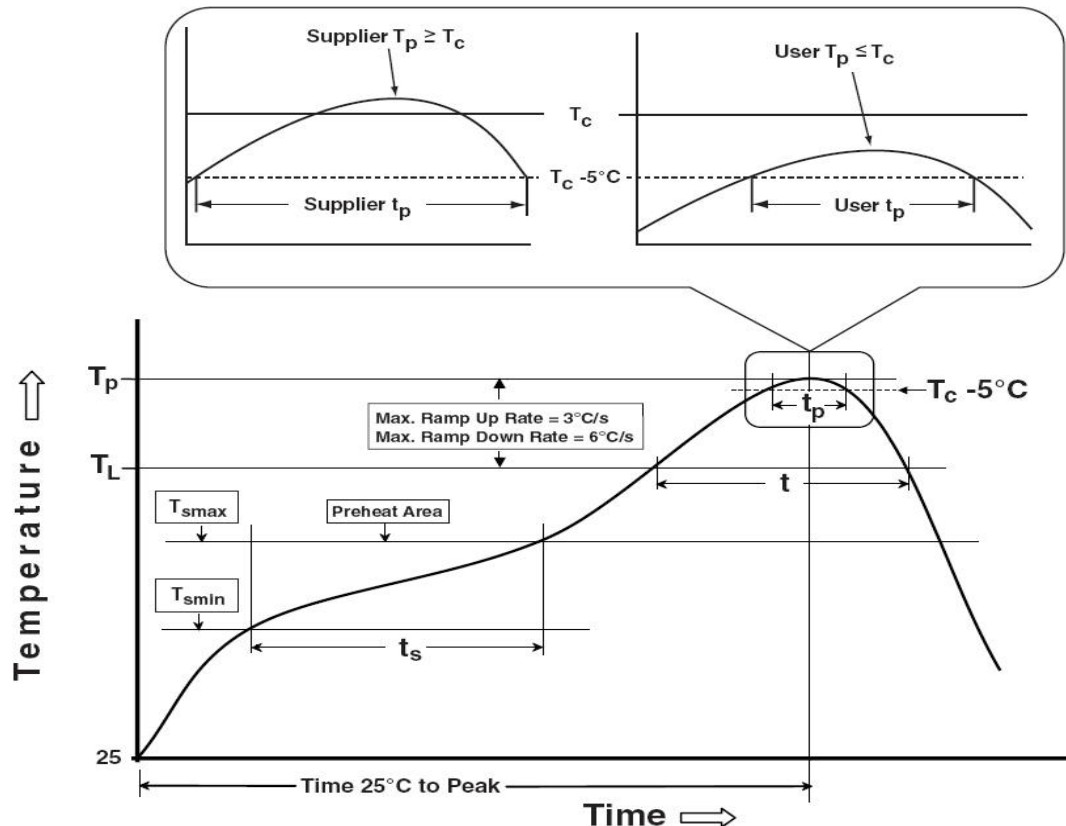

## Precautions for Use

### Storage:

#### 1. Before opening the package

The LEDs should be kept at  $<40$  &  $<90\%RH$ . The LEDs should be used within a year. When storing the LEDs, moisture proof package with absorbent material (silica gel) is recommended.

#### 2. After opening the package

The LEDs should be kept at  $\leq 30$  &  $\leq 60\%RH$ . The LEDs should be soldered within 168 hours (7days) after opening the moisture proof package.

If unused LEDs remain, they should be stored in moisture proof packages, such as sealed containers with moisture proof package within absorbent material (silica gel). It is also recommended to return the unused LEDs to the original moisture proof package and to seal the moisture proof package again.

If the moisture absorbent material (silica gel) vapors or expires the expiration date, baking treatment should be performed by using the following conditions :  $60$  °C for 20 hours.

The LEDs electrode and leadframe comprise a silver plated copper alloy. The silver surface may be affected by environments. Please avoid conditions which may cause the LEDs being corroded or discolored. The corrosion or discoloration might lower solderability or affect optical characteristics.

Please avoid rapid transition in ambient temperature, especially in high humidity environments where condensation can occur.

### Static Electricity:

1. The products are sensitive to static electricity, and care should be taken when handling them.

2. Static electricity or surge voltage will damage the LEDs. It is recommended to wear a anti-electrostatic wristband or an anti-electrostatic gloves when handling the LEDs.

3. All devices, equipment and machinery must be properly grounded. It is recommended that measures be taken against surge voltage to the equipment that mounts the LEDs.

## History of Changes

Rev	Date	Description of Change
01	01/01/2019	Initial Release

The products, their specifications and other information appearing in this document are subject to change by Luminus Devices without notice. Luminus Devices assumes no liability for errors that may appear in this document, and no liability otherwise arising from the application or use of the product or information contained herein. None of the information provided herein should be considered to be a representation of the fitness or suitability of the product for any particular application or as any other form of warranty. Luminus Devices' product warranties are limited to only such warranties as accompany a purchase contract or purchase order for such products. Nothing herein is to be construed as constituting an additional warranty. No information contained in this publication may be considered as a waiver by Luminus Devices of any intellectual property rights that Luminus Devices may have in such information. Big Chip LEDs™ is a registered trademark of Luminus Devices, Inc., all rights reserved.

This product is protected by U.S. Patents 6,831,302; 7,074,631; 7,083,993; 7,084,434; 7,098,589; 7,105,861; 7,138,666; 7,166,870; 7,166,871; 7,170,100; 7,196,354; 7,211,831; 7,262,550; 7,274,043; 7,301,271; 7,341,880; 7,344,903; 7,345,416; 7,348,603; 7,388,233; 7,391,059 Patents Pending in the U.S. and other countries.