

## SERIES: AMT21 | DESCRIPTION: MODULAR ABSOLUTE ENCODER

### FEATURES

- high speed protocol for fast low latency position data
- patented capacitive ASIC technology
- low power consumption
- 12 or 14-bit absolute position with multi-turn capability
- 3.3 V half-duplex RS485 - high speed 2 Mbps or adjustable data rate
- settable zero position
- configuration and programming via AMT Viewpoint™ software
- compact modular package with locking hub for ease of installation
- radial and axial cable connections
- -40 ~ 105°C operating temperature



### ELECTRICAL

parameter	conditions/description	min	typ	max	units
power supply	VDD	3.8	5	5.5	V
start-up time <sup>1</sup>			200		ms
current consumption	with unloaded output		16		mA

Note: 1. Encoder must be stationary during start-up.

### ABSOLUTE POSITION CHARACTERISTICS

parameter	conditions/description	min	typ	max	units
resolution	12 or 14-bit				
accuracy			0.2		degrees
absolute zero position	settable via AMT Viewpoint™ GUI or RS485 (single-turn versions only)				
multi-turn	multi-turn and single-turn versions available				
turns counter <sup>2</sup>	signed binary number		14		bits
absolute position update rate	12-bit 14-bit		25 100		μs μs

Notes: 2. Multi-turn encoders only.

### MECHANICAL

parameter	conditions/description	min	typ	max	units
motor shaft length		9			mm
motor shaft tolerance			NOM +0/-0.015		mm
weight			15.7		g
axial play				±0.3	mm
rotational speed at each resolution	12-bit position resolution 14-bit position resolution			8,000 4,000	RPM RPM

## ENVIRONMENTAL

parameter	conditions/description	min	typ	max	units
operating temperature		-40		105	°C
humidity	non-condensing			85	%
vibration	10~500 Hz, 5 minute sweep, 2 hours on each XYZ			5	G
shock	3 pulses, 6 ms, 3 on each XYZ			200	G
RoHS	yes				
REACH	EC 1907/2006				

## RS485 INTERFACE - 2 MBPS DATA RATE (A,B,C,D OPTIONS)

parameter	conditions/description	min	typ	max	units
protocol	RS485 balanced digital multi-port interface				
data rate	8 data bits, no parity, 1 stop bit, asynchronous		2		Mbps
transceiver	Texas Instruments SN65HVD75				
turnaround time	time before encoder responds with position	3			µs
driver differential output voltage magnitude	load resistance = 54 Ω	1.5	2	3.3	V

## RS485 INTERFACE - ADJUSTABLE DATA RATE (E,F,G,H OPTIONS)

parameter	conditions/description	min	typ	max	units
protocol	RS485 balanced digital multi-port interface				
data rate <sup>3,4</sup>	8 data bits, no parity, 1 stop bit, asynchronous 115,200; 38,400; 19,200; 9,600				bps
transceiver	Texas Instruments SN65HVD72				
turnaround time	time before encoder responds with position 115,200 bps 38,400 bps 19,200 bps 9,600 bps	10.8 30 56 110			µs µs µs µs
driver differential output voltage magnitude	load resistance = 54 Ω	1.5	2	3.3	V

Notes: 3. Data rate configured with AMT Viewpoint™  
4. Default data rate on kits is 115,200 bps.

## Checksum

The AMT21 encoder uses a checksum calculation for detecting transmission errors. The upper two bits of every response from the encoder are check bits. Those values are shown in the examples below as K1 and K0. The check bits are odd parity; K1 for the odd bits in the response, and K0 for the even bits in the response. These check bits are not part of the position, but are used to verify its validity. The remaining lower 14 bits are the useful data. Here is an example of how to calculate the checkbits for a 16-bit response, from a 14-bit encoder.

Full response: 0x61AB

14-bit position: 0x21AB (8619 decimal)

### Checkbit Formula

Odd:  $K1 = !(H5 \wedge H3 \wedge H1 \wedge L7 \wedge L5 \wedge L3 \wedge L1)$

Even:  $K0 = !(H4 \wedge H2 \wedge H0 \wedge L6 \wedge L4 \wedge L2 \wedge L0)$

From the above response 0x61AB:

Odd:  $0 = !(1 \wedge 0 \wedge 0 \wedge 1 \wedge 1 \wedge 1 \wedge 1) = \text{correct}$

Even:  $1 = !(0 \wedge 0 \wedge 1 \wedge 0 \wedge 0 \wedge 0 \wedge 1) = \text{correct}$

## RS485 INTERFACE (CONTINUED)

### Addressing

The AMT21 encoder supports multiple encoders on the RS485 bus. This is accomplished by giving each encoder a unique node address. This node address is 8 bits long but the low two bits must be 0. Therefore, the encoder can have any single byte value that is divisible by 4 which allows up to 64 encoders to share the bus.

By default, the node address is 0x54. Node addresses configurable via AMT Viewpoint™ or set at factory for specific configuration upon request.

Available RS485 Node Addresses (HEX)							
00	20	40	60	80	A0	C0	E0
04	24	44	64	84	A4	C4	E4
08	28	48	68	88	A8	C8	E8
0C	2C	4C	6C	8C	AC	CC	EC
10	30	50	70	90	B0	D0	F0
14	34	<b>54*</b>	74	94	B4	D4	F4
18	38	58	78	98	B8	D8	F8
1C	3C	5C	7C	9C	BC	DC	FC

\*Default address

The node address serves also as the read position command which is why it will be referred to it as the base command. When the encoder sees a command on the RS485 it reads the first 6 bits to determine if it should be listening. If it sees its address, then it interprets the low two bits for the command.

Low two bits	Hex	Command
00	0x00	Read position
01	0x01	Read turns counter (multi-turn encoders only)
10	0x02	Indicates extended command
11	0x03	Reserved

For simplicity the user can abstract away the various bits and simply implement multiple commands in their system. For example:

Byte	Command
0x54	Read position
0x55	Read turns counter (multi-turn encoders only)
0x56	Begin extended command

### Extended Commands

There are some commands that require two bytes to be received before the encoder will enact them. This includes resets and zero saves. This prevents collisions and allows the encoder to be fully functional while sharing the bus with other encoders.

Note that there are no responses to these instructions, and once received the encoder initiates an immediate reset. The user's system should expect to wait until the encoder is powered back up to send any follow up commands. Power on time is listed in the electrical section above.

To send an extended command the user will send the <node address + 0x02> value (0x56 by default) followed by the <extended command>.

Extended Commands	Function
0x5E	Set zero position (Single turn encoders only)
0x75	Reset encoder

## RS485 INTERFACE EXAMPLES

### Single character commands

*Read Position:* <node\_address>

#### Read Position 0x54

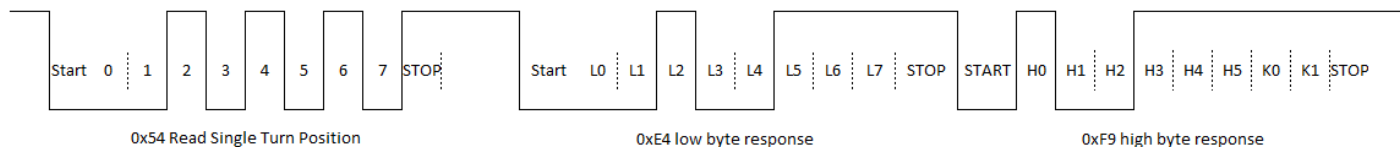

The read position command is the same as the node address which has a default value of 0x54 is sent and the response is received with the low byte first. After removing the checksum the result is 0x39E4. For a 14-bit encoder nothing else is required, the position is 14820 in decimal. However if this is a 12-bit encoder, the position must be shifted to the right 2 bits to throw away the low bits of the response. Therefore the position would be 3705 in decimal.

*Read Turns (multi-turn encoders only):* <node\_address + 0x01>

#### Read Turns 0x55

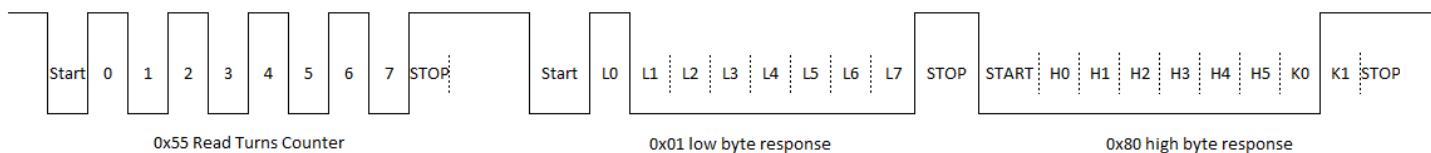

The turns counter command is <node\_address + 0x01>. By default the turns counter command is 0x55. The encoder responds with the low byte first and includes check bits same as the read position command. The resulting number is a signed 14 bit number. The response above is showing 1 turn.

### Extended commands

*Set Zero Position (single turn encoders only):* <node\_address + 0x02> <0x5E>

#### Set Zero Position 0x56 0x5E - Single Turn Encoders Only

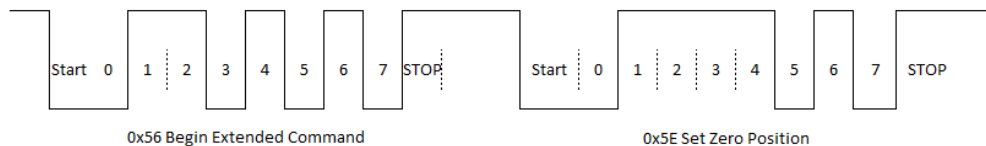

The zero set command is <node\_address + 0x02> followed by <0x5E>. By default we send 0x56 and then 0x5E. The encoder zero's the position and immediately resets.

*Encoder Reset:* <node\_address + 0x02> <0x75>

#### Reset Encoder 0x56 0x75



The reset command is <node\_address + 0x02> followed by <0x75>. By default the command to reset the encoder is 0x56 0x75. The encoder performs and immediate reset.

## PART NUMBER KEY

For customers that prefer a specific AMT21 configuration, please reference the custom configuration key below.

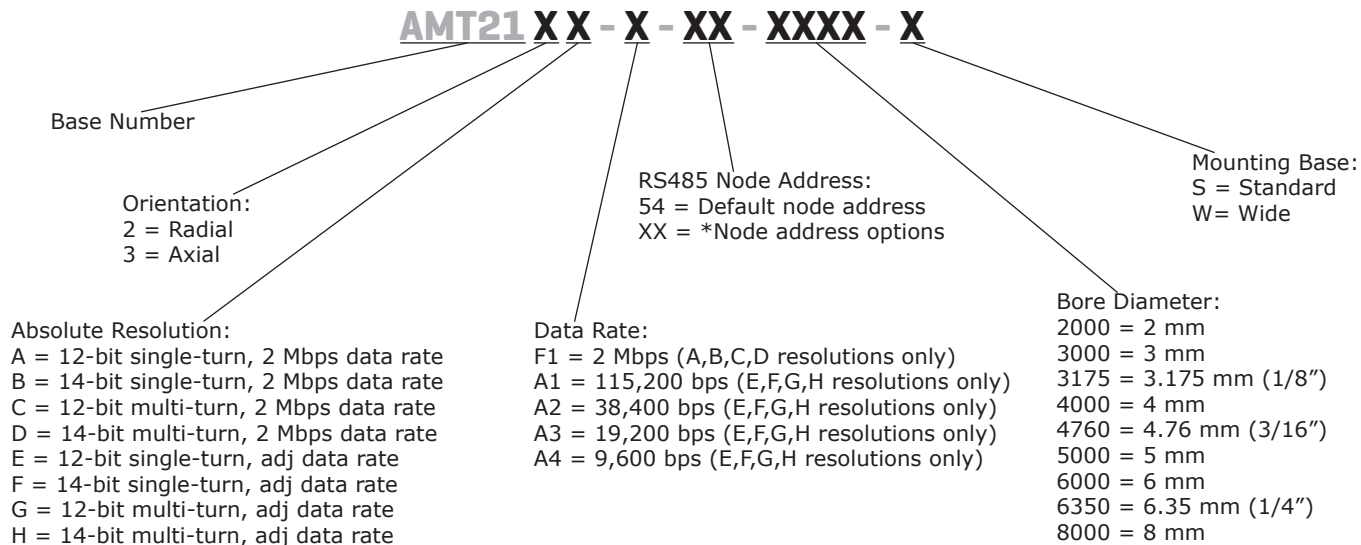

\*Reference RS485 Interface Addressing section on page 3 for help selecting node address.

## AMT21-V KITS

In order to provide maximum flexibility for our customers, the AMT21 series is provided in kit form standard. This allows the user to implement the encoder into a range of applications using one sku#, reducing engineering and inventory costs.

### ORDERING GUIDE

#### AMT21XX-V

**Orientation:**  
2 = Radial  
3 = Axial

**Absolute Resolution:**  
A = 12-bit single-turn, 2 Mbps data rate  
B = 14-bit single-turn, 2 Mbps data rate  
C = 12-bit multi-turn, 2 Mbps data rate  
D = 14-bit multi-turn, 2 Mbps data rate  
E = 12-bit single-turn, adj data rate  
F = 14-bit single-turn, adj data rate  
G = 12-bit multi-turn, adj data rate  
H = 14-bit multi-turn, adj data rate

SLEEVES								
2mm	3mm	1/8 inch (3.175mm)	4mm	3/16 inch (4.76mm)	5mm	6mm	1/4 inch (6.35mm)	8mm
Light Sky Blue	Orange	Purple	Gray	Yellow	Green	Red	Snow	Blue

BASE	WIDE BASE	TOP COVER	SHAFT ADAPTER	TOOL A	TOOL C

## ENCODER INTERFACE

PINOUT CONNECTOR	
#	Function
1	+5 V
2	B
3	A
4	GND
5 <sup>1</sup>	MODE
6 <sup>1</sup>	MCLR

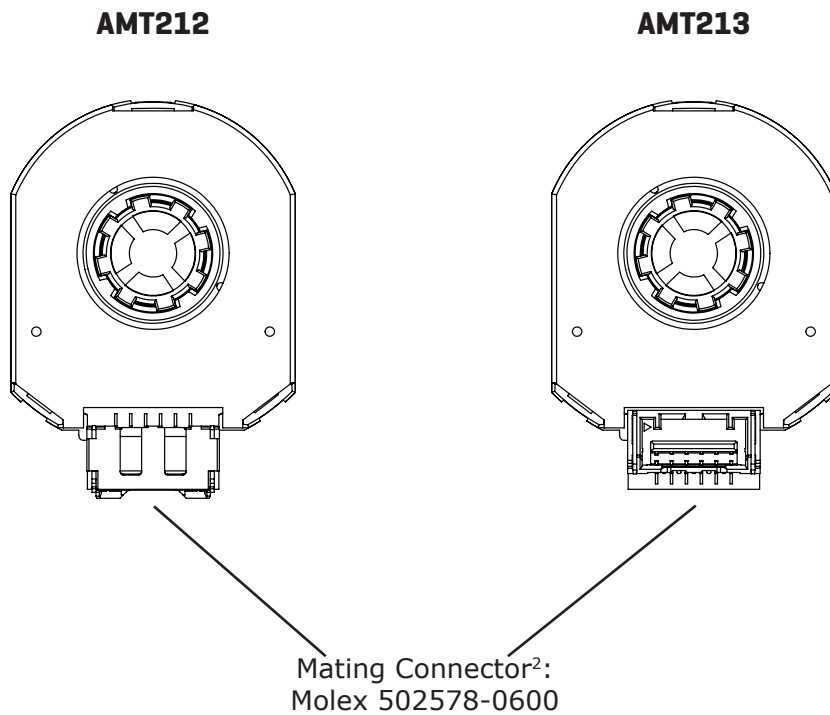

- Notes:
1. Pins 5 and 6 are used for configuration only and should be left disconnected for RS485.
  2. Compatible with prototype cable AMT-06C-1-036 and programming cable AMT-06C-1-036-USB.

## MECHANICAL DRAWING

### AMT212

units: mm

tolerance:  $\pm 0.1$

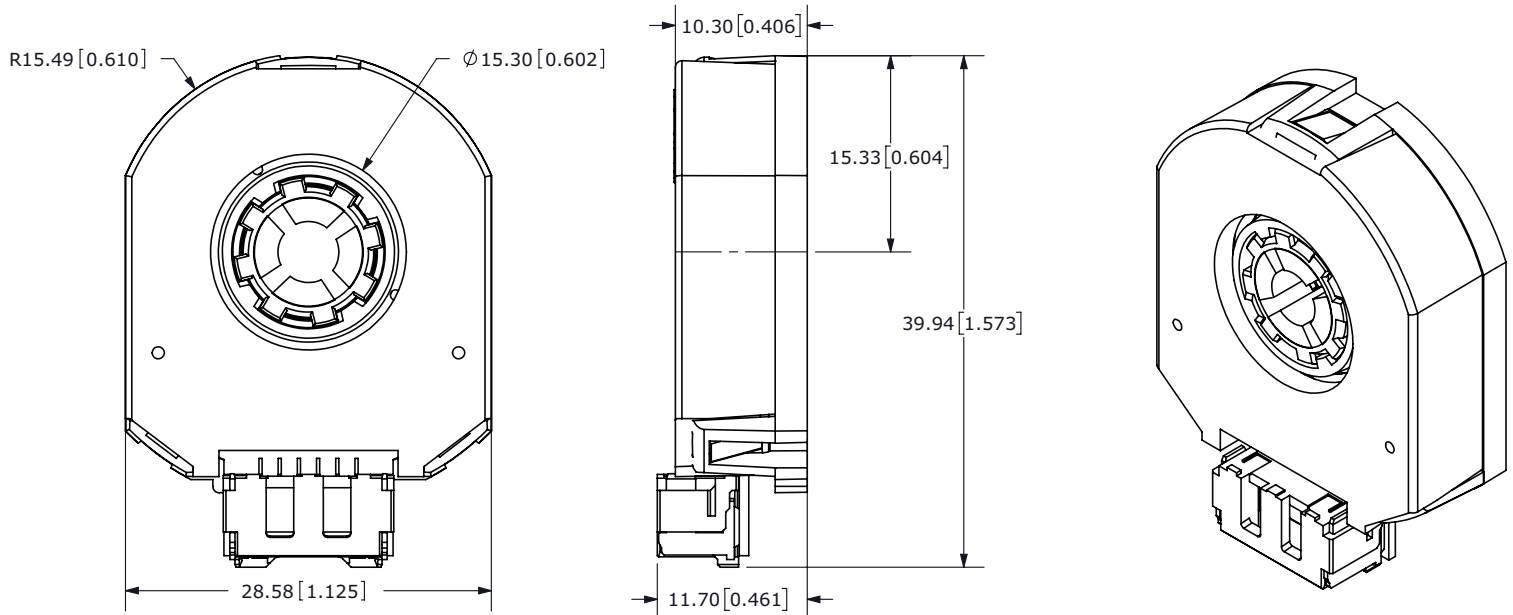

### AMT213

units: mm

tolerance:  $\pm 0.1$

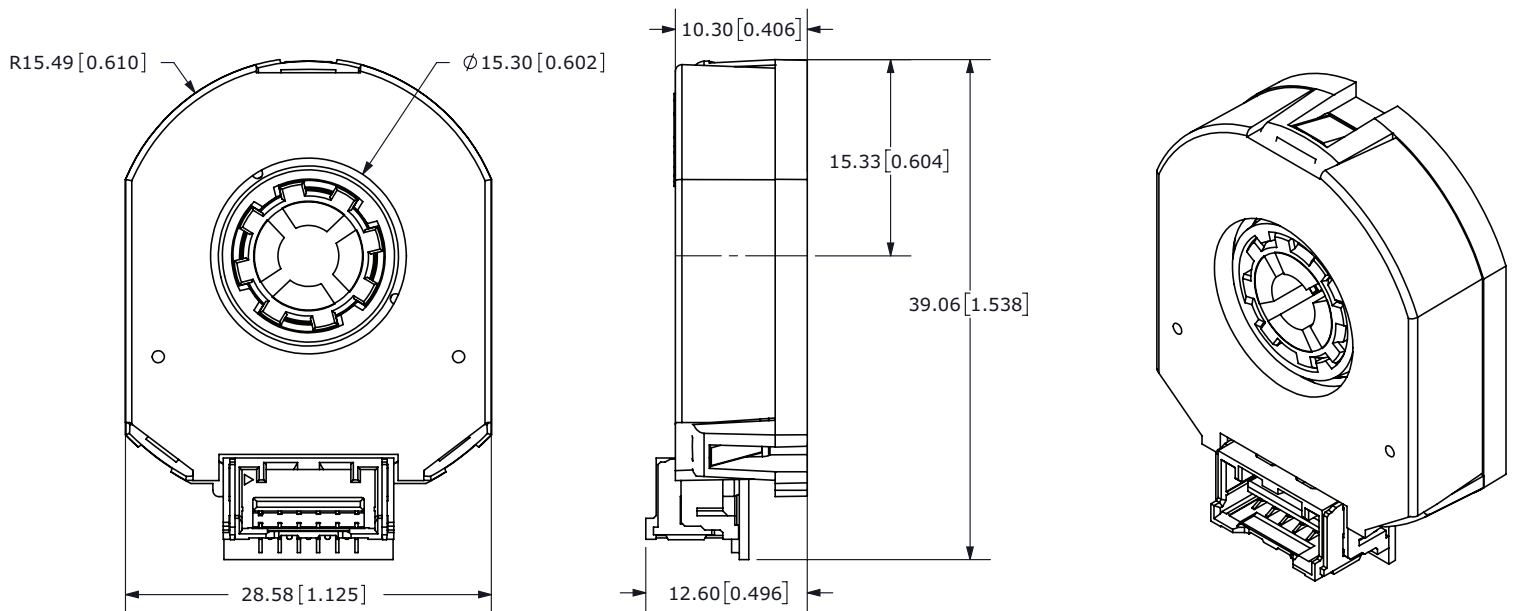

## MECHANICAL DRAWING (CONTINUED)

### MOUNTING HOLE PATTERNS

#### STANDARD BASE

units: mm[inch]  
tolerance:  $\pm 0.1$

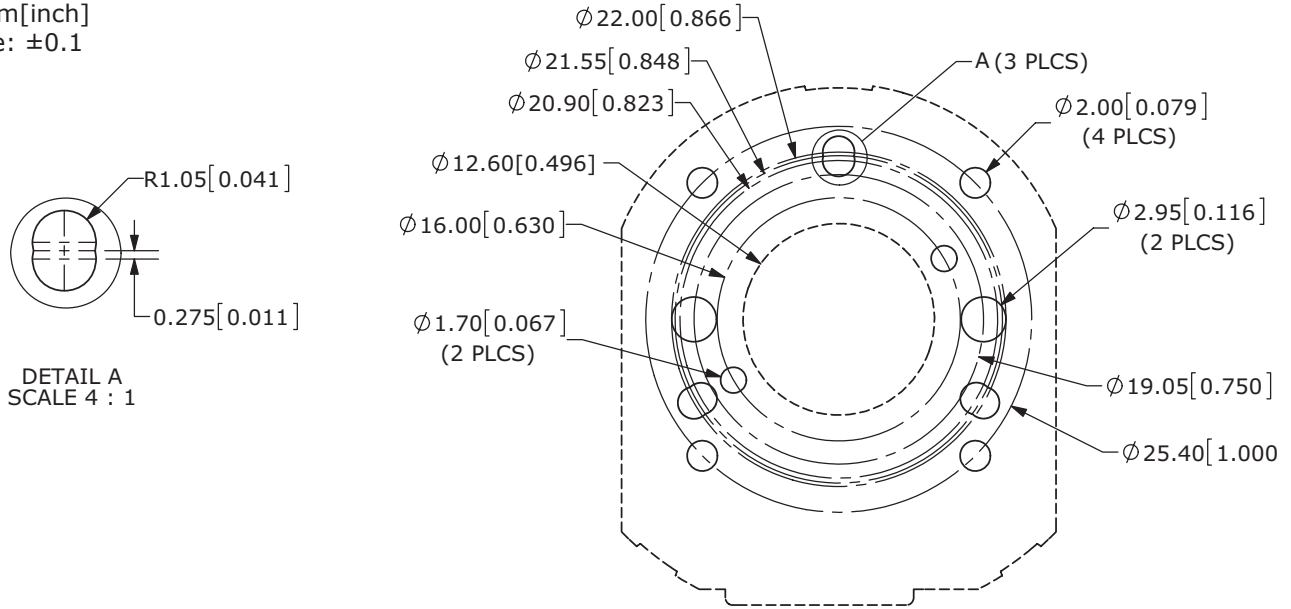

#### WIDE BASE

units: mm[inch]  
tolerance:  $\pm 0.1$





## ASSEMBLY PROCEDURE

### STEP 1

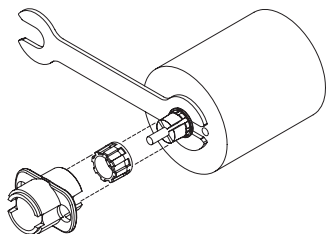

1. Insert Tool A as a spacer that defines the distance to the mounting surface.
2. Slide appropriate sized Sleeve over shaft all the way down to Tool A.
3. Slide Shaft Adaptor over Sleeve.
4. Use Tool C to press Shaft Adaptor over Sleeve (ensure Shaft Adaptor and Tool C spline alignment) until flush with Tool A.

### STEP 2

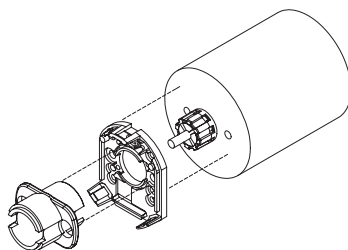

1. Remove Tools A and C.
2. Place Base on motor, with Tool C used as a centering tool.

### STEP 3

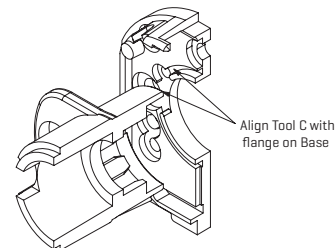

1. Align Tool C with flange on Base.
2. Slide Base and Tool C onto motor, centering onto the Shaft Adaptor.

### STEP 4

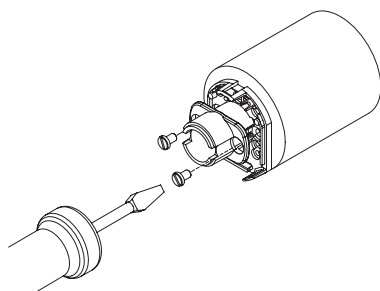

1. Fasten the Base on the motor (Tool C may need to be rotated to allow for some mounting configurations).
2. Remove Tool C.

### STEP 5

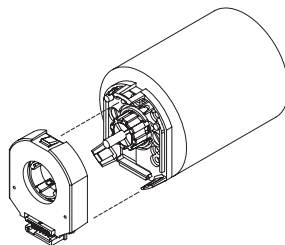

1. Snap the Top Cover onto the Base, carefully observing that the teeth of the Shaft Adaptor align with the grooves in the hub. \*

\* We recommend no more than three cycles of mounting and removal of the AMT top cover base. Multiple cycles of mounting and removing the top cover can cause base fatigue over time and affect encoder performance.

### STEP 6

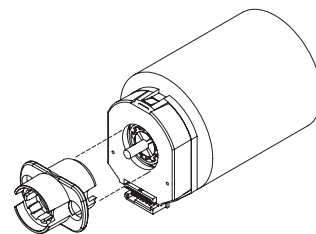

1. Make sure the snaps are fully engaged by pressing on the Hub with the reverse side of Tool C.
2. When assembly is finished, the Shaft Adaptor, Sleeve and Rotor Hub should all be flush with the Motor Shaft rotating freely.

## REVISION HISTORY

---

rev.	description	date
1.0	initial release	02/20/2018
1.01	added serial interface details	05/15/2018
1.02	added multi-turn serial interface details	06/29/2018
1.03	updated RS485 interface details	06/26/2019
1.04	added adjustable data rate options	08/22/2019
1.05	brand update	11/21/2019
1.06	added motor shaft tolerance details, updated start-up details	09/10/2021

The revision history provided is for informational purposes only and is believed to be accurate.

---

# CUI DEVICES

CUI Devices offers a one (1) year limited warranty. Complete warranty information is listed on our website.

CUI Devices reserves the right to make changes to the product at any time without notice. Information provided by CUI Devices is believed to be accurate and reliable. However, no responsibility is assumed by CUI Devices for its use, nor for any infringements of patents or other rights of third parties which may result from its use.

CUI Devices products are not authorized or warranted for use as critical components in equipment that requires an extremely high level of reliability. A critical component is any component of a life support device or system whose failure to perform can be reasonably expected to cause the failure of the life support device or system, or to affect its safety or effectiveness.