

General Description

The AAT1153 SwitchReg™ is a 1.2MHz constant frequency current mode PWM step-down converter. It is ideal for portable equipment requiring very high current up to 2A from single-cell Lithium-ion batteries while still achieving over 90% efficiency during peak load conditions. The AAT1153 also can run at 100% duty cycle for low dropout operation, extending battery life in portable systems while light load operation provides very low output ripple for noise sensitive applications.

The AAT1153 can supply up to 2A output load current from a 2.5V to 5.5V input voltage and the output voltage can be regulated as low as 0.6V. The high switching frequency minimizes the size of external components while keeping switching losses low. The internal slope compensation setting allows the device to operate with smaller inductor values to optimize size and provide efficient operation.

The AAT1153 is available in adjustable (0.6V to V_{IN}) and fixed (1.8V) output voltage versions. The device is available in a Pb-free, 3mm x 3mm 10-lead TDFN package and is rated over the -40°C to +85°C temperature range.

Features

- Input Voltage Range: 2.5V to 5.5V
- Output Voltages from 0.6V to V_{IN}
- 2A Output Current
- High Efficiency: Up to 95%
- 1.2MHz Constant Switching Frequency
- Low $R_{DS(ON)}$ Internal Switches: 0.15 Ω
- Allows Use of Ceramic Capacitors
- Current Mode Operation for Excellent Line and Load Transient Response
- Short-Circuit and Thermal Fault Protection
- Soft Start
- Low Dropout Operation: 100% Duty Cycle
- Low Shutdown Current: $I_{SHUTDOWN} < 1\mu A$
- TDFN33-10 Package
- -40°C to +85°C Temperature Range

Applications

- Cellular Phones
- Digital Cameras
- DSP Core Supplies
- PDAs
- Portable Instruments
- Smart Phones

Typical Application

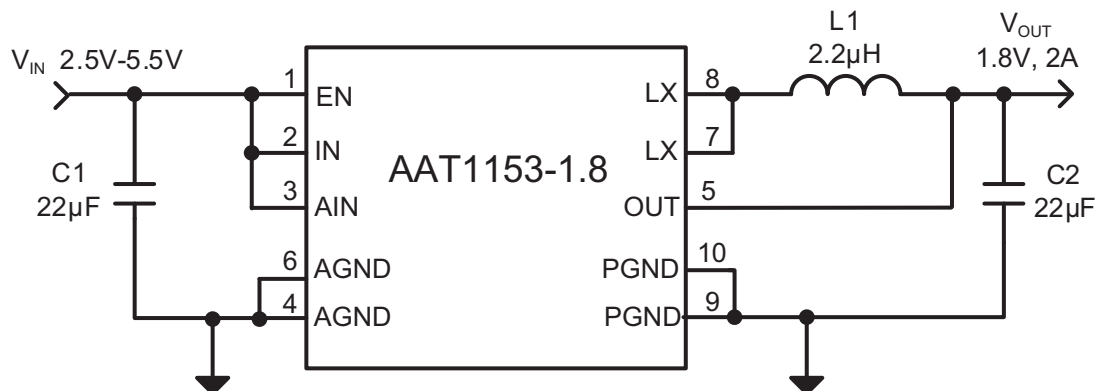

Pin Descriptions

Pin #	Symbol	Function
1	EN	Enable pin. Active high. In shutdown, all functions are disabled drawing <math><1\mu\text{A}</math> supply current. Do not leave EN floating.
2	IN	Power supply input pin. Must be closely decoupled to AGND with a 2.2 μF or greater ceramic capacitor.
3	AIN	Analog supply input pin. Provides bias for internal circuitry.
4, 6	AGND	Analog ground pin
5	FB/OUT	FB pin (AAT1153IDE-0.6): Adjustable version feedback input. Connect FB to the center point of the external resistor divider. The feedback threshold voltage is 0.6V. OUT pin (AAT1153IDE-1.8): Fixed version feedback input. Connect OUT to the output voltage, VOUT.
7, 8	LX	Switching node pin. Connect the output inductor to this pin.
9, 10	PGND	Power ground pin
	EP	Power ground exposed pad. Must be connected to bare copper ground plane.

Pin Configuration

**TDFN-10
(Top View)**

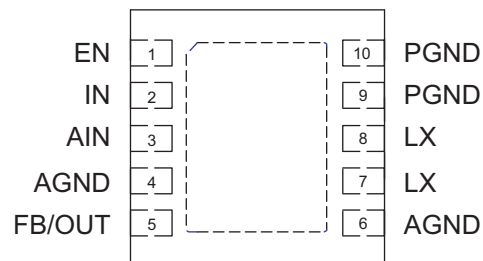

1. FB pin for the adjustable voltage version (AAT1153IDE-0.6), OUT pin for the fixed voltage version (AAT1153IDE-1.8).

Absolute Maximum Ratings¹

Symbol	Description	Value	Units
IN, AIN	Input Supply Voltages	-0.3 to 6.0	V
V _{FB} , V _{LX}	FB, LX Voltages	-0.3 to V _{IN} + 0.3	V
V _{EN}	EN Voltage	-0.3 to V _{IN} + 0.3	V
PGND, AGND	Ground Voltages	-0.3 to 6.0	V
T _A	Operating Temperature Range	-40 to +85	°C
T _{STORAGE}	Storage Temperature	-65 to 150	°C
T _{LEAD}	Lead Temperature (Soldering, 10s)	300	°C

Thermal Information²

Symbol	Description	Value	Units
θ _{JA}	Thermal Resistance ³	45	°C/W
P _D	Maximum Thermal Dissipation at T _A = 25°C	2.2	W

1. Absolute Maximum Ratings are those values beyond which the life of a device may be impaired.

2. T_j is calculated from the ambient temperature T_A and power dissipation P_D according to the following formula: T_j = T_A + P_D × θ_{JA}.

3. Thermal Resistance is specified with approximately 1 square inch of 1 oz. copper.

Electrical Characteristics¹

$V_{IN} = 3.6V$, $T_A = -40^{\circ}C$ to $+85^{\circ}C$ unless otherwise noted; typical values are $T_A = 25^{\circ}C$.

Symbol	Description	Conditions	Min	Typ	Max	Units
V_{IN}	Input Voltage Range ²		2.5		5.5	V
V_{OUT}	Output Voltage Range		0.6		V_{IN}	V
I_Q	Input DC Supply Current	Active Mode: $V_{FB} = 0.5V$		300	500	μA
		Shutdown Mode: $V_{EN} = 0V$, $V_{AIN} = 5.5V$		0.1	1	μA
I_{FB}	Feedback Input Bias Current	$V_{FB} = 0.65V$			30	nA
V_{FB}	Regulated Feedback Voltage ³	$T_A = 25^{\circ}C$	0.5880	0.6000	0.6120	V
		$0^{\circ}C \leq T_A \leq 85^{\circ}C$	0.5865	0.6000	0.6135	
		$-40^{\circ}C \leq T_A \leq 85^{\circ}C$	0.5850	0.6000	0.6150	
$\frac{\Delta V_{LINEREG}}{\Delta V_{IN}}$	Line Regulation	$V_{IN} = 2.5V$ to $5.5V$, $I_{OUT} = 10mA$		0.10	0.20	%/V
$\frac{\Delta V_{LOADREG}}{\Delta I_{OUT}}$	Load Regulation	$I_{OUT} = 10mA$ to $2000mA$		0.20		%/A
V_{FB}	Output Voltage Accuracy	$V_{IN} = 2.5$ to $5.5V$, $I_{OUT} = 10$ to $2000mA$	-3		+3	% V_{OUT}
F_{OSC}	Oscillator Frequency	$V_{FB} = 0.6V$	0.96	1.2	1.44	MHz
T_S	Startup Time	From Enable to Output Regulation		1.3		ms
T_{SD}	Over-Temperature Shutdown Threshold			170		$^{\circ}C$
T_{HYS}	Over-Temperature Shutdown Hysteresis			10		$^{\circ}C$
I_{LIM}	Peak Switch Current		2.5	3.5		A
$R_{DS(ON)}$	P-CH MOSFET	$V_{IN} = 3.6V$		135	200	m Ω
	N-CH MOSFET	$V_{IN} = 3.6V$		95	150	
$V_{EN(L)}$	Enable Threshold Low				0.3	V
$V_{EN(H)}$	Enable Threshold High		1.5			V
I_{EN}	Input Low Current	$V_{IN} = V_{EN} = 5.5V$	-1.0		1.0	μA

1. The AAT1153 is guaranteed to meet performance specifications over the $-40^{\circ}C$ to $+85^{\circ}C$ operating temperature range and is assured by design, characterization, and correlation with statistical process controls.

2. V_{IN} should be not less than $V_{OUT} + V_{DROPOUT}$, where $V_{DROPOUT} = I_{OUT} \times (R_{DS(ON)PMOS} + ESR_{INDUCTOR})$, typically $V_{DROPOUT} = 0.3V$.

3. The regulated feedback voltage is tested in an internal test mode that connects V_{FB} to the output of the error amplifier.

Typical Characteristics

Efficiency vs. Output Current

($V_{OUT} = 3.3V$, $T_A = 25^\circ C$, $L = 2.2\mu H$, $C_{IN} = C_{OUT} = 22\mu F$)

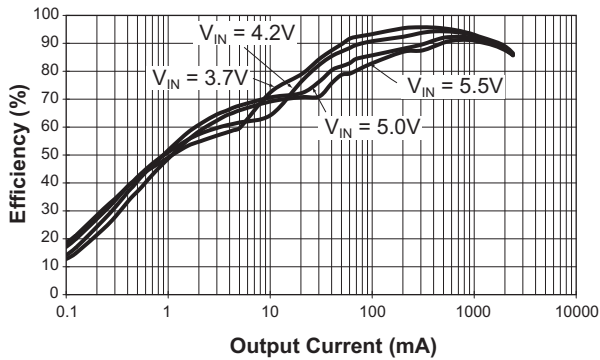

DC Regulation

($V_{OUT} = 3.3V$, $T_A = 25^\circ C$, $L = 2.2\mu H$, $C_{IN} = C_{OUT} = 22\mu F$)

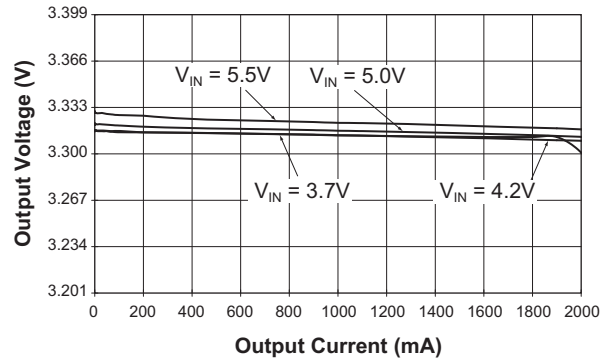

Efficiency vs. Output Current

($V_{OUT} = 1.8V$, $T_A = 25^\circ C$, $L = 2.2\mu H$, $C_{IN} = C_{OUT} = 22\mu F$)

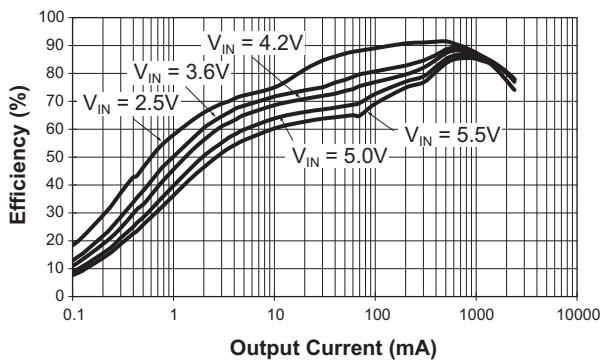

DC Regulation

($V_{OUT} = 1.8V$, $T_A = 25^\circ C$, $L = 2.2\mu H$, $C_{IN} = C_{OUT} = 22\mu F$)

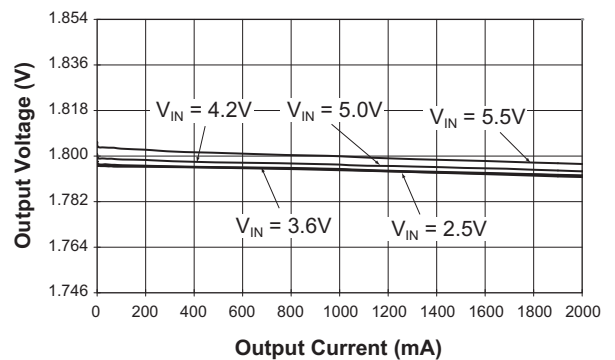

Efficiency vs. Output Current

($V_{OUT} = 1.5V$, $T_A = 25^\circ C$, $L = 2.2\mu H$, $C_{IN} = C_{OUT} = 22\mu F$)

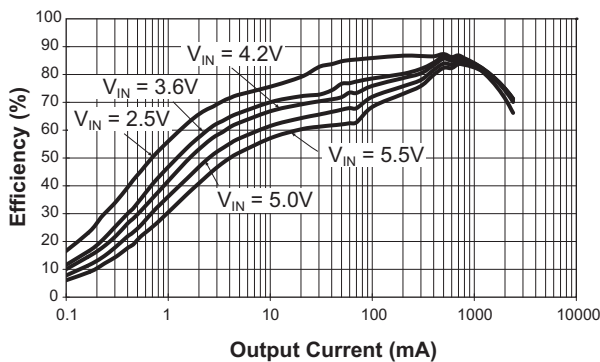

DC Regulation

($V_{OUT} = 1.5V$, $T_A = 25^\circ C$, $L = 2.2\mu H$, $C_{IN} = C_{OUT} = 22\mu F$)

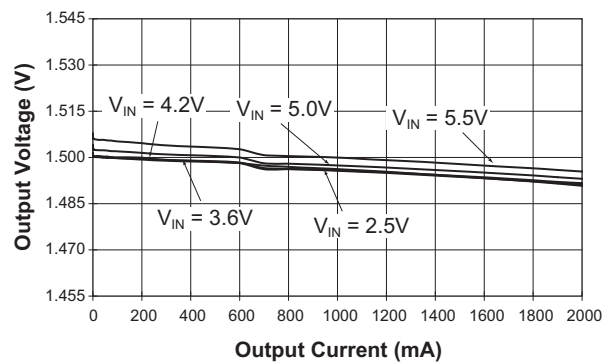

Typical Characteristics

Efficiency vs. Output Current

($V_{OUT} = 1.2V$, $T_A = 25^\circ C$, $L = 2.2\mu H$, $C_{IN} = C_{OUT} = 22\mu F$)

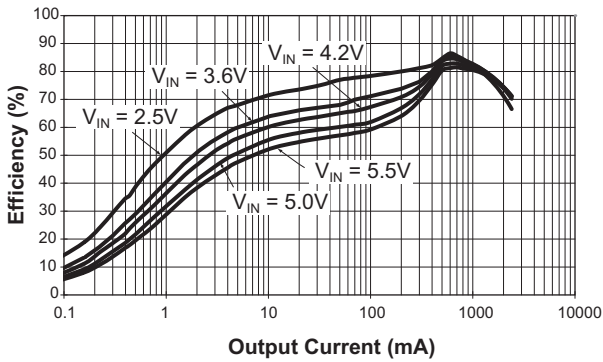

DC Regulation

($V_{OUT} = 1.2V$, $T_A = 25^\circ C$, $L = 2.2\mu H$, $C_{IN} = C_{OUT} = 22\mu F$)

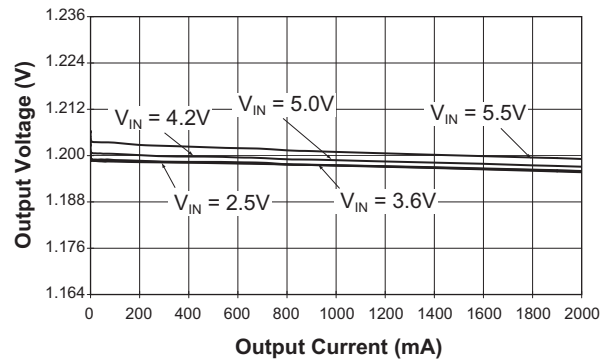

Quiescent Current vs. Input Voltage

($T_A = 25^\circ C$, $L = 2.2\mu H$, $C_{IN} = C_{OUT} = 22\mu F$)

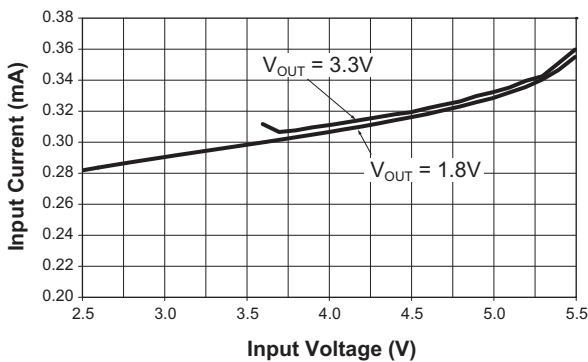

Quiescent Current vs. Temperature

($L = 2.2\mu H$, $C_{IN} = C_{OUT} = 22\mu F$)

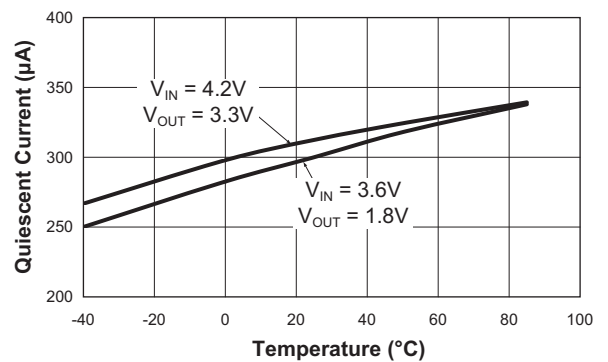

Line Regulation

($V_{OUT} = 1.8V$, $L = 2.2\mu H$, $C_{IN} = C_{OUT} = 22\mu F$)

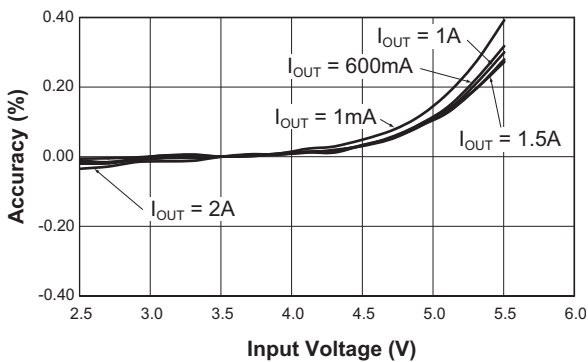

Typical Characteristics

P-Channel $R_{DS(ON)}$ vs. Input Voltage

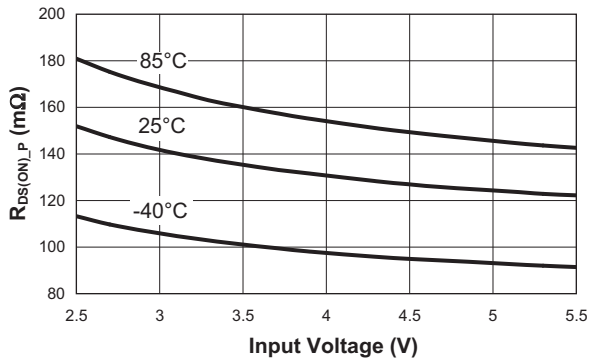

N-Channel $R_{DS(ON)}$ vs. Input Voltage

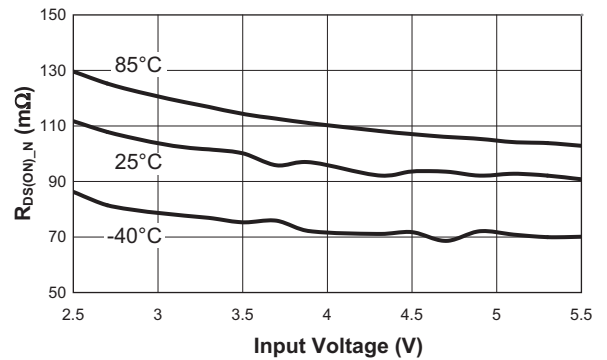

Switching Frequency vs. Temperature
($V_{IN} = 3.6V$; $V_{OUT} = 1.8V$)

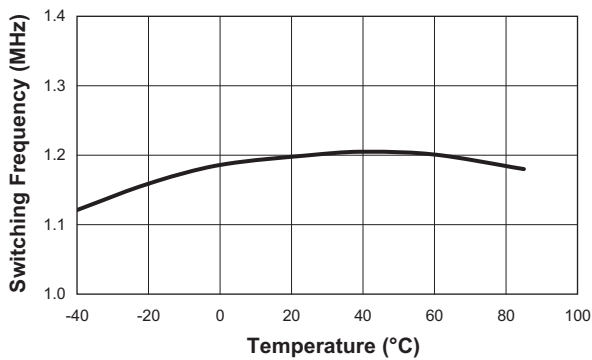

Reference Voltage vs. Temperature
($V_{IN} = 3.6V$)

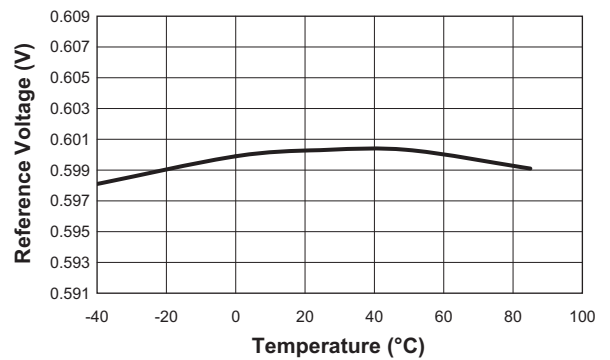

Soft Start

($V_{IN} = 3.6V$; $V_{OUT} = 1.8V$; $I_{OUT} = 2A$; $C_{FF} = 22\mu F$)

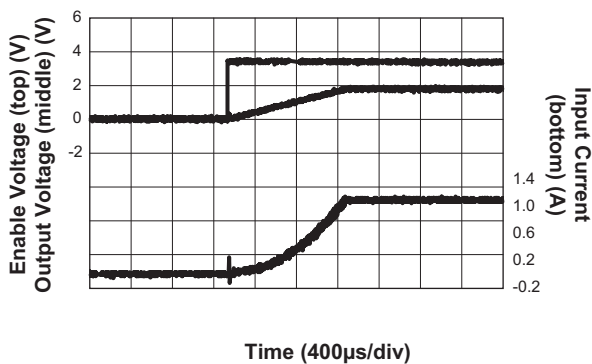

Load Transient Response

($V_{IN} = 3.6V$; $V_{OUT} = 1.8V$; $L = 2.2\mu H$; $C_{IN} = C_{OUT} = 22\mu F$)

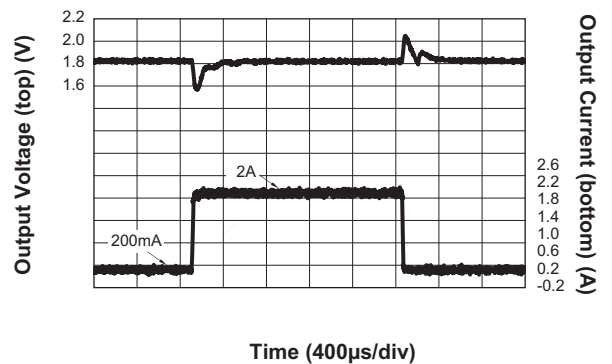

Typical Characteristics

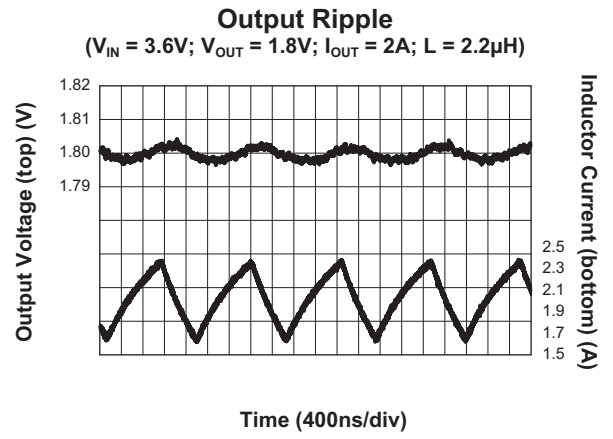
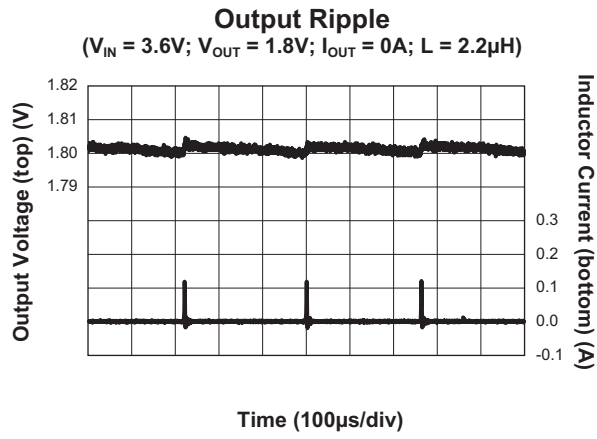

Functional Block Diagram

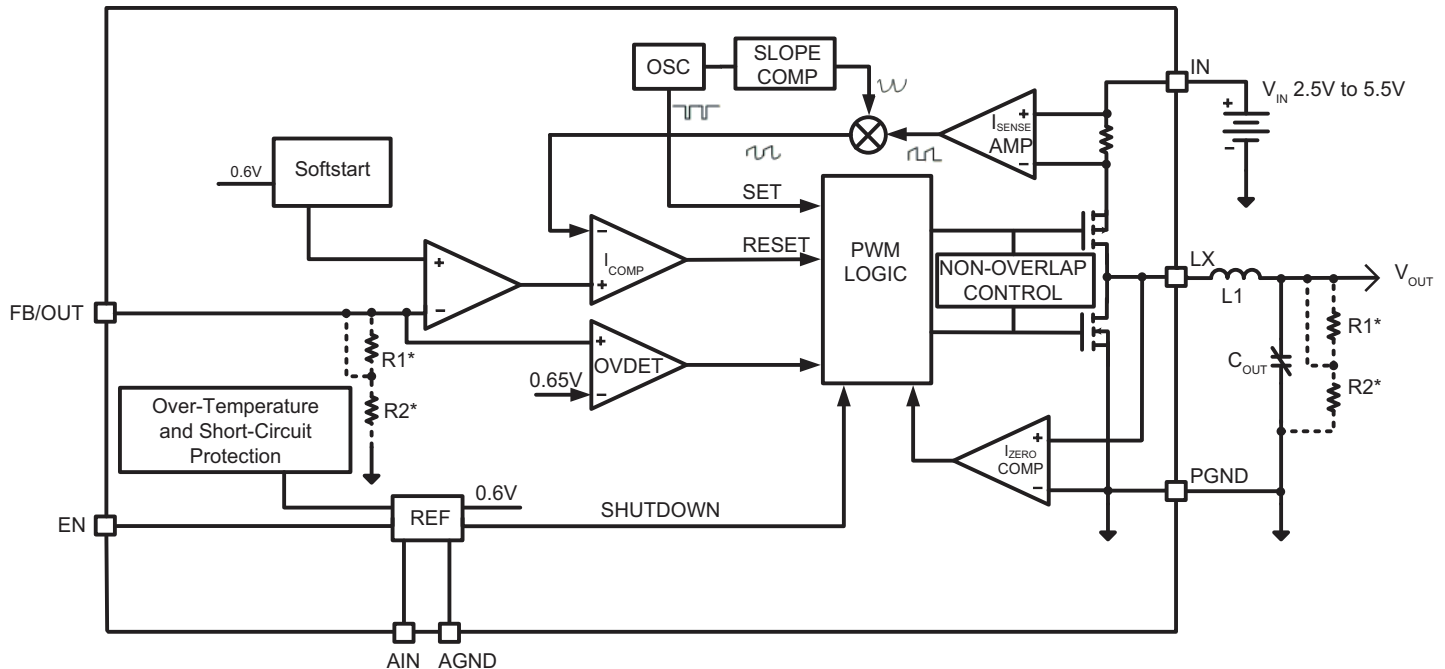

*The resistor divider $R1 + R2$ is internally set for the fixed output versions, and is externally set for the adjustable output versions.

Functional Description

The AAT1153 is a high output current monolithic switch-mode step-down DC-DC converter. The device operates at a fixed 1.2MHz switching frequency, and uses a slope compensated current mode architecture. This step-down DC-DC converter can supply up to 2A output current at $V_{IN} = 3V$ and has an input voltage range from 2.5V to 5.5V. It minimizes external component size and optimizes efficiency at the heavy load range. The slope compensation allows the device to remain stable over a wider range of inductor values so that smaller values ($1\mu H$ to $4.7\mu H$) with lower DCR can be used to achieve higher efficiency. Apart from the small bypass input capacitor, only a small L-C filter is required at the output. The fixed output version requires only three external power components (C_{IN} , C_{OUT} , and L). The adjustable version can be programmed with external feedback to any voltage, ranging from 0.6V to near the input voltage. It uses internal MOSFETs to achieve high efficiency and can generate very low output voltages by using an internal reference of 0.6V. At dropout, the converter duty cycle increases to 100% and the output voltage tracks the input voltage minus the low $R_{DS(ON)}$ drop of the P-channel

high-side MOSFET and the inductor DCR. The internal error amplifier and compensation provides excellent transient response, load and line regulation. Internal soft start eliminates any output voltage overshoot when the enable or the input voltage is applied.

Current Mode PWM Control

Slope compensated current mode PWM control provides stable switching and cycle-by-cycle current limit for excellent load and line response with protection of the internal main switch (P-channel MOSFET) and synchronous rectifier (N-channel MOSFET). During normal operation, the internal P-channel MOSFET is turned on for a specified time to ramp the inductor current at each rising edge of the internal oscillator, and switched off when the peak inductor current is above the error voltage. The current comparator, I_{COMP} , limits the peak inductor current. When the main switch is off, the synchronous rectifier turns on immediately and stays on until either the inductor current starts to reverse, as indicated by the current reversal comparator, I_{ZERO} , or the beginning of the next clock cycle.

Control Loop

The AAT1153 is a peak current mode step-down converter. The current through the P-channel MOSFET (high side) is sensed for current loop control, as well as short circuit and overload protection. A slope compensation signal is added to the sensed current to maintain stability for duty cycles greater than 50%. The peak current mode loop appears as a voltage-programmed current source in parallel with the output capacitor. The output of the voltage error amplifier programs the current mode loop for the necessary peak switch current to force a constant output voltage for all load and line conditions. Internal loop compensation terminates the transconductance voltage error amplifier output. For fixed voltage versions, the error amplifier reference voltage is internally set to program the converter output voltage. For the adjustable output, the error amplifier reference is fixed at 0.6V.

Soft Start / Enable

Soft start limits the current surge seen at the input and eliminates output voltage overshoot. The enable pin is active high. When pulled low, the enable input (EN) forces the AAT1153 into a low-power, non-switching state. The total input current during shutdown is less than 1 μ A.

Current Limit and Over-Temperature Protection

For overload conditions, the peak input current is limited to 3.5A. To minimize power dissipation and stresses under current limit and short-circuit conditions, switching is terminated after entering current limit for a series of pulses. The termination lasts for seven consecutive clock cycles after a current limit has been sensed during a series of four consecutive clock cycles.

Thermal protection completely disables switching when internal dissipation becomes excessive. The junction over-temperature threshold is 170°C with 10°C of hysteresis. Once an over-temperature or over-current fault conditions is removed, the output voltage automatically recovers.

Dropout Operation

When the battery input voltage decreases near the value of the output voltage, the AAT1153 allows the main switch to remain on for more than one switching cycle and increases the duty cycle until it reaches 100%. The duty cycle D of a step-down converter is defined as:

$$D = T_{ON} \cdot F_{OSC} \cdot 100\% \approx \frac{V_{OUT}}{V_{IN}} \cdot 100\%$$

Where T_{ON} is the main switch on time and F_{OSC} is the oscillator frequency. The output voltage then is the input voltage minus the voltage drop across the main switch and the inductor. At low input supply voltage, the $R_{DS(ON)}$ of the P-channel MOSFET increases, and the efficiency of the converter decreases. Caution must be exercised to ensure the heat dissipated does not exceed the maximum junction temperature of the IC.

Maximum Load Current

The AAT1153 will operate with an input supply voltage as low as 2.5V, however, the maximum load current decreases at lower input voltages due to a large IR drop on the main switch and synchronous rectifier. The slope compensation signal reduces the peak inductor current as a function of the duty cycle to prevent sub-harmonic oscillations at duty cycles greater than 50%. Conversely the current limit increases as the duty cycle decreases.

Applications Information

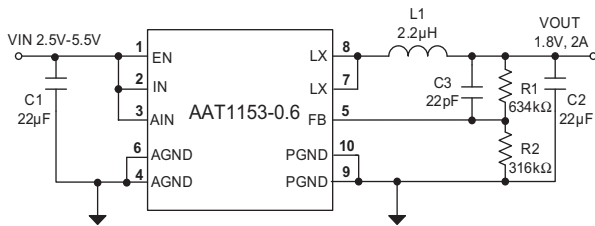

Figure 1: Basic Application Circuit for the Adjustable Output Version.

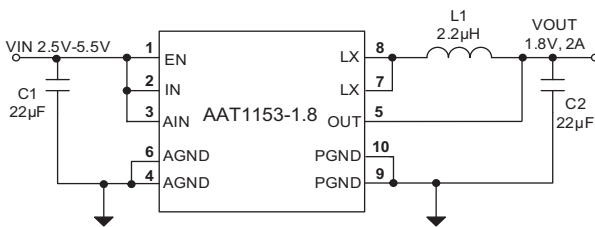

Figure 2: Basic Application Circuit for the Fixed Output Versions.

Setting the Output Voltage

Figure 1 shows the basic application circuit with the AAT1153 adjustable output version while Figure 2 shows the application circuit with the AAT1153 fixed output version. For applications requiring an adjustable output voltage, the AAT1153-0.6 adjustable version can be externally programmed. Resistors R1 and R2 in Figure 1 program the output to regulate at a voltage higher than 0.6V. To limit the bias current required for the external feedback resistor string while maintaining good noise immunity, the minimum suggested value for R2 is 59kΩ. Although a larger value will further reduce quiescent current, it will also increase the impedance of the feedback node, making it more sensitive to external noise and interference. Table 1 summarizes the resistor values for various output voltages with R2 set to either 59kΩ for good noise immunity or 316kΩ for reduced no load input current.

The adjustable version of the AAT1153, combined with an external feed forward capacitor (C3 in Figure 1), delivers enhanced transient response for extreme pulsed load applications. The addition of the feed forward capacitor typically requires a larger output capacitor C2

for stability. The external resistor sets the output voltage according to the following equation:

$$V_{OUT} = 0.6V \cdot \left(1 + \frac{R1}{R2} \right)$$

$$R1 = \left(\frac{V_{OUT}}{0.6V} - 1 \right) \cdot R2$$

Table 1 shows the resistor selection for different output voltage settings.

V _{OUT} (V)	R2 = 59kΩ R1 (kΩ)	R2 = 316kΩ R1 (kΩ)
0.8	19.6	105
0.9	29.4	158
1.0	39.2	210
1.1	49.9	261
1.2	59.0	316
1.3	68.1	365
1.4	78.7	422
1.5	88.7	475
1.8	118	634
1.85	124	655
2.0	137	732
2.5	187	1000
3.3	267	1430

Table 1: Resistor Selections for Different Output Voltage Settings (Standard 1% Resistors Substituted For Calculated Values).

Inductor Selection

For most designs, the AAT1153 operates with inductor values of 1μH to 4.7μH. Low inductance values are physically smaller but require faster switching, which results in some efficiency loss. The inductor value can be derived from the following equation:

$$L = \frac{V_{OUT} \cdot (V_{IN} - V_{OUT})}{V_{IN} \cdot \Delta I_L \cdot f_{OSC}}$$

Where ΔI_L is inductor ripple current. Large value inductors lower ripple current and small value inductors result in high ripple currents. Choose inductor ripple current approximately 30% of the maximum load current 2A, or

$$\Delta I_L = 600mA$$

2A Step-Down Converter

For output voltages above 2.0V, when light-load efficiency is important, the minimum recommended inductor is 2.2μH.

Manufacturer's specifications list both the inductor DC current rating, which is a thermal limitation, and the peak current rating, which is determined by the saturation characteristics. The inductor should not show any appreciable saturation under normal load conditions. Some inductors may meet the peak and average current ratings yet result in excessive losses due to a high DCR.

Always consider the losses associated with the DCR and its effect on the total converter efficiency when selecting an inductor. For optimum voltage-positioning load transients, choose an inductor with DC series resistance in the 20mΩ to 100mΩ range. For higher efficiency at heavy loads (above 200mA), or minimal load regulation (but some transient overshoot), the resistance should be kept below 100mΩ. The DC current rating of the inductor should be at least equal to the maximum load current plus half the ripple current to prevent core saturation (2A + 600mA). Table 2 lists some typical surface mount inductors that meet target applications for the AAT1153.

For example, the 2.2μH CDRH5D16-2R2 inductor selected from Sumida has a 28.7mΩ DCR and a 3.0ADC current rating. At full load, the inductor DC loss is 57mW which gives a 1.6% loss in efficiency for a 1200mA, 1.8V output.

Slope Compensation

The AAT1153 step-down converter uses peak current mode control with slope compensation for stability when duty cycles are greater than 50%. The slope compensation is set to maintain stability with lower value inductors which provide better overall efficiency. The output inductor value must be selected so the inductor current down slope meets the internal slope compensation requirements. As an example, the value of the slope compensation is set to 1A/μs which is large enough to guarantee stability when using a 2.2μH inductor for all output voltage levels from 0.6V to 3.3V.

The worst case external current slope (m) using the 2.2μH inductor is when $V_{OUT} = 3.3V$ and is:

$$m = \frac{V_{OUT}}{L} = \frac{3.3}{2.2} = 1.5A/\mu s$$

To keep the power supply stable when the duty cycle is above 50%, the internal slope compensation (mA) should be:

$$m_a \geq \frac{1}{2} \cdot m = 0.75A/\mu s$$

Therefore, to guarantee current loop stability, the slope of the compensation ramp must be greater than one-half of the down slope of the current waveform. So the internal slope compensated value of 1A/μs will guarantee stability using a 2.2μH inductor value for all output voltages from 0.6V to 3.3V.

Input Capacitor Selection

The input capacitor reduces the surge current drawn from the input and switching noise from the device. The input capacitor impedance at the switching frequency should be less than the input source impedance to prevent high frequency switching current passing to the input. The calculated value varies with input voltage and is a maximum when V_{IN} is double the output voltage.

$$C_{IN} = \frac{\frac{V_O}{V_{IN}} \cdot \left(1 - \frac{V_O}{V_{IN}}\right)}{\left(\frac{V_{PP}}{I_O} - ESR\right) \cdot f_s}$$

$$C_{IN(MIN)} = \frac{1}{\left(\frac{V_{PP}}{I_O} - ESR\right) \cdot 4 \cdot f_s}$$

A low ESR input capacitor sized for maximum RMS current must be used. Ceramic capacitors with X5R or X7R dielectrics are highly recommended because of their low ESR and small temperature coefficients. A 22μF ceramic capacitor for most applications is sufficient. A large value may be used for improved input voltage filtering.

The maximum input capacitor RMS current is:

$$I_{RMS} = I_O \cdot \sqrt{\frac{V_O}{V_{IN}} \cdot \left(1 - \frac{V_O}{V_{IN}}\right)}$$

2A Step-Down Converter

The input capacitor RMS ripple current varies with the input and output voltage and will always be less than or equal to half of the total DC load current.

$$I_{\text{RMS(MAX)}} = \frac{1}{2} \cdot I_{\text{O}}$$

To minimize stray inductance, the capacitor should be placed as closely as possible to the IC. This keeps the high frequency content of the input current localized, minimizing EMI and input voltage ripple. The proper placement of the input capacitor (C1) can be seen in the evaluation board layout in Figures 3 and 4.

A laboratory test set-up typically consists of two long wires running from the bench power supply to the evaluation board input voltage pins. The inductance of these wires, along with the low-ESR ceramic input capacitor, can create a high Q network that may affect converter performance. This problem often becomes apparent in the form of excessive ringing in the output voltage during load transients. Errors in the loop phase and gain measurements can also result.

Since the inductance of a short PCB trace feeding the input voltage is significantly lower than the power leads from the bench power supply, most applications do not exhibit this problem.

In applications where the input power source lead inductance cannot be reduced to a level that does not affect the converter performance, a high ESR tantalum or aluminum electrolytic should be placed in parallel with the low ESR, ESL bypass ceramic. This dampens the high Q network and stabilizes the system.

Output Capacitor Selection

The function of output capacitance is to store energy to attempt to maintain a constant voltage. The energy is stored in the capacitor's electric field due to the voltage applied.

The value of output capacitance is generally selected to limit output voltage ripple to the level required by the specification. Since the ripple current in the output inductor is usually determined by L , V_{OUT} and V_{IN} , the series impedance of the capacitor primarily determines the output voltage ripple. The three elements of the capacitor that contribute to its impedance (and output voltage

ripple) are equivalent series resistance (ESR), equivalent series inductance (ESL), and capacitance (C).

The output voltage droop due to a load transient is dominated by the capacitance of the ceramic output capacitor. During a step increase in load current, the ceramic output capacitor alone supplies the load current until the loop responds. Within three switching cycles, the loop responds and the inductor current increases to match the load current demand. The relationship of the output voltage droop during the three switching cycles to the output capacitance can be estimated by:

$$C_{\text{OUT}} = \frac{3 \cdot \Delta I_{\text{LOAD}}}{V_{\text{DROOP}} \cdot f_{\text{S}}}$$

In many practical designs, to get the required ESR, a capacitor with much more capacitance than is needed must be selected.

For both continuous or discontinuous inductor current mode operation, the ESR of the C_{OUT} needed to limit the ripple to ΔV_{O} , V peak-to-peak is:

$$\text{ESR} \leq \frac{\Delta V_{\text{O}}}{\Delta I_{\text{L}}}$$

Ripple current flowing through a capacitor's ESR causes power dissipation in the capacitor. This power dissipation causes a temperature increase internal to the capacitor. Excessive temperature can seriously shorten the expected life of a capacitor. Capacitors have ripple current ratings that are dependent on ambient temperature and should not be exceeded. The output capacitor ripple current is the inductor current, I_{L} , minus the output current, I_{O} . The RMS value of the ripple current flowing in the output capacitance (continuous inductor current mode operation) is given by:

$$I_{\text{RMS}} = \Delta I_{\text{L}} \cdot \frac{\sqrt{3}}{6} = \Delta I_{\text{L}} \cdot 0.289$$

ESL can be a problem by causing ringing in the low megahertz region but can be controlled by choosing low ESL capacitors, limiting lead length (PCB and capacitor), and replacing one large device with several smaller ones connected in parallel.

2A Step-Down Converter

In conclusion, in order to meet the requirement of output voltage ripple small and regulation loop stability, ceramic capacitors with X5R or X7R dielectrics are recommended due to their low ESR and high ripple current ratings. The output ripple V_{OUT} is determined by:

$$\Delta V_{OUT} \leq \frac{V_{OUT} \cdot (V_{IN} - V_{OUT})}{V_{IN} \cdot f_{OSC} \cdot L} \cdot \left(ESR + \frac{1}{8 \cdot f_{OSC} \cdot C_{OUT}} \right)$$

A 22 μ F ceramic capacitor can satisfy most applications.

Thermal Calculations

There are three types of losses associated with the AAT1153 step-down converter: switching losses, conduction losses, and quiescent current losses. Conduction losses are associated with the $R_{DS(ON)}$ characteristics of the power output switching devices. Switching losses are dominated by the gate charge of the power output switching devices. At full load, assuming continuous conduction mode (CCM), a simplified form of the losses is given by:

$$P_{TOTAL} = \frac{I_O^2 \cdot (R_{DS(ON)(HS)} \cdot V_O + R_{DS(ON)(LS)} \cdot [V_{IN} - V_O])}{V_{IN}} + (t_{sw} \cdot F \cdot I_O + I_Q) \cdot V_{IN}$$

I_Q is the step-down converter quiescent current. The term t_{sw} is used to estimate the full load step-down converter switching losses.

For the condition where the step-down converter is in dropout at 100% duty cycle, the total device dissipation reduces to:

$$P_{TOTAL} = I_O^2 \cdot R_{DS(ON)(HS)} + I_Q \cdot V_{IN}$$

Since $R_{DS(ON)}$, quiescent current, and switching losses all vary with input voltage, the total losses should be investigated over the complete input voltage range. Given the total losses, the maximum junction temperature can be derived from the θ_{JA} for the DFN-10 package which is 45°C/W.

$$T_{J(MAX)} = P_{TOTAL} \cdot \theta_{JA} + T_{AMB}$$

Layout Guidance

When laying out the PC board, the following layout guideline should be followed to ensure proper operation of the AAT1153:

1. The exposed pad (EP) must be reliably soldered to the GND plane. A PGND pad below EP is strongly recommended.
2. The power traces, including the GND trace, the LX trace and the IN trace should be kept short, direct and wide to allow large current flow. The L1 connection to the LX pins should be as short as possible. Use several VIA pads when routing between layers.
3. The input capacitor (C1) should connect as closely as possible to IN (Pin 2) and AGND (Pins 4 and 6) to get good power filtering.
4. Keep the switching node, LX (Pins 7 and 8) away from the sensitive FB/OUT node.
5. The feedback trace or OUT pin (Pin 2) should be separate from any power trace and connect as closely as possible to the load point. Sensing along a high-current load trace will degrade DC load regulation. If external feedback resistors are used, they should be placed as closely as possible to the FB pin (Pin 5) to minimize the length of the high impedance feedback trace.
6. The output capacitor C2 and L1 should be connected as closely as possible. The connection of L1 to the LX pin should be as short as possible and there should not be any signal lines under the inductor.
7. The resistance of the trace from the load return to PGND should be kept to a minimum. This will help to minimize any error in DC regulation due to differences in the potential of the internal signal ground and the power ground.

Figures 4, 5 and 6 show an example of a layout with 4 layers. The internal 2 layers are SGND and PGND.

2A Step-Down Converter

Manufacturer	Part Number	Inductance (μH)	Max DC Current (A)	DCR (mΩ)	Size LxWxH (mm)	Type
Sumida	CDRH5D16	2.2	3.0	28.7	5.8x5.8x1.8	Shielded
Sumida		3.3	2.6	35.6		
Sumida		4.7	3.4	19		
Coiltronics	SD53	2.0	3.3	23	5.2x5.2x3.0	Shielded
Coiltronics		3.3	2.6	29		
Coiltronics		4.7	2.1	39		

Manufacturer	Part Number	Value	Voltage (V)	Temp. Co.	Case
Murata	GRM219R60J106KE19	10μF	6.3	X5R	0805
Murata	GRM21BR60J226ME39	22μF	6.3	X5R	0805
Murata	GRM1551X1E220JZ01B	22pF	25	JIS	0402

Table 2: Suggested Component Selection Information.

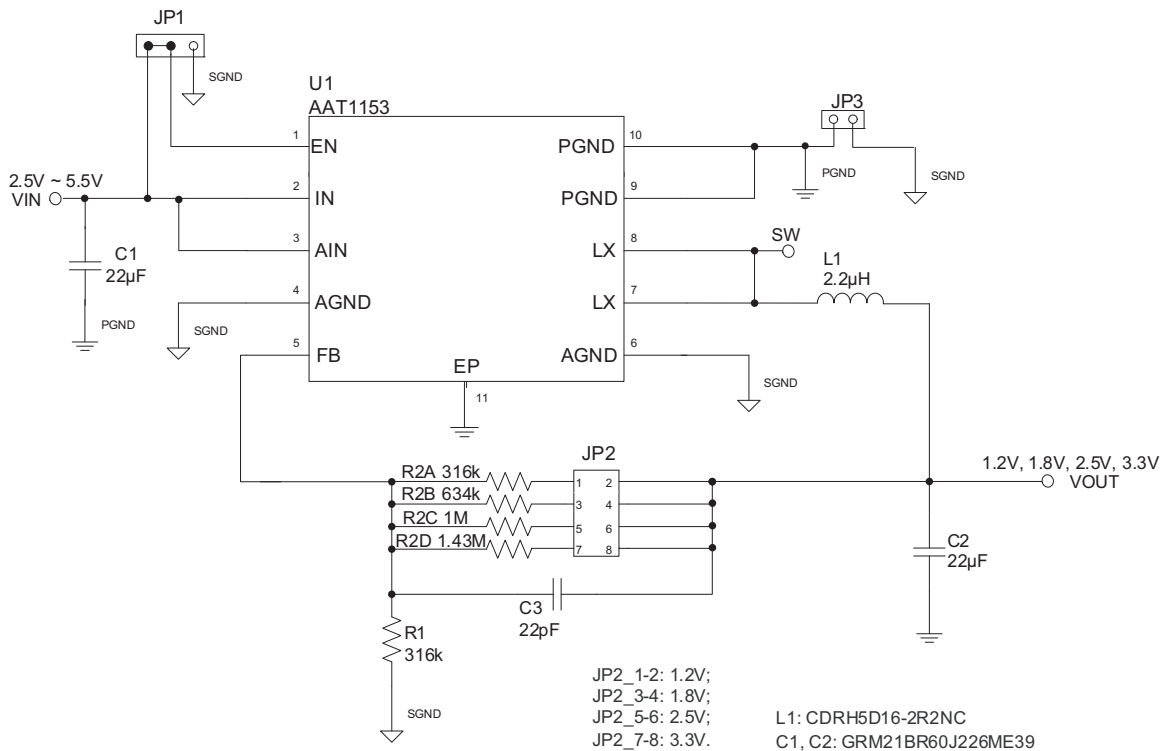

Figure 3: AAT1153 Adjustable Voltage Version Recommended Evaluation Board Schematic.

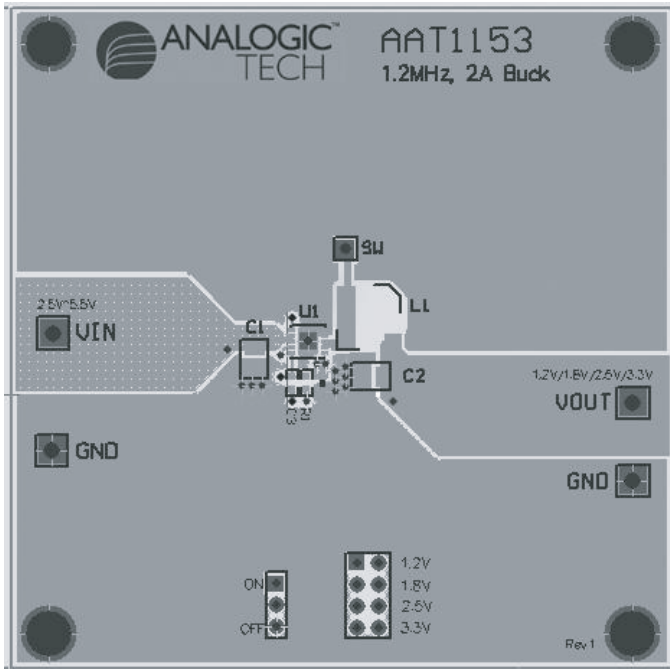

Figure 4: AAT1153 Evaluation Board Component Side Layout.

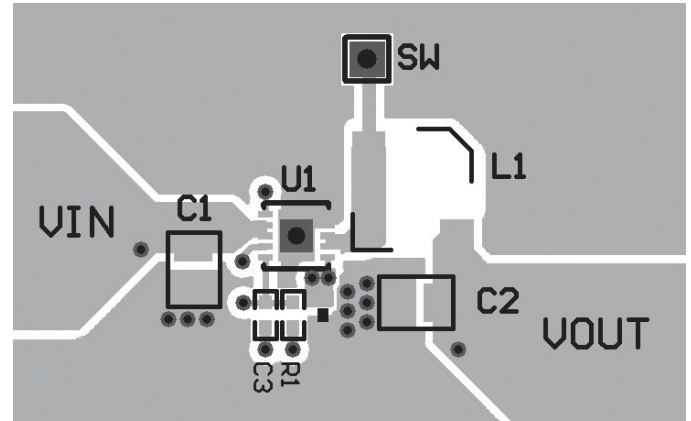

Figure 5: Exploded View of AAT1153 Evaluation Board Component Side Layout.

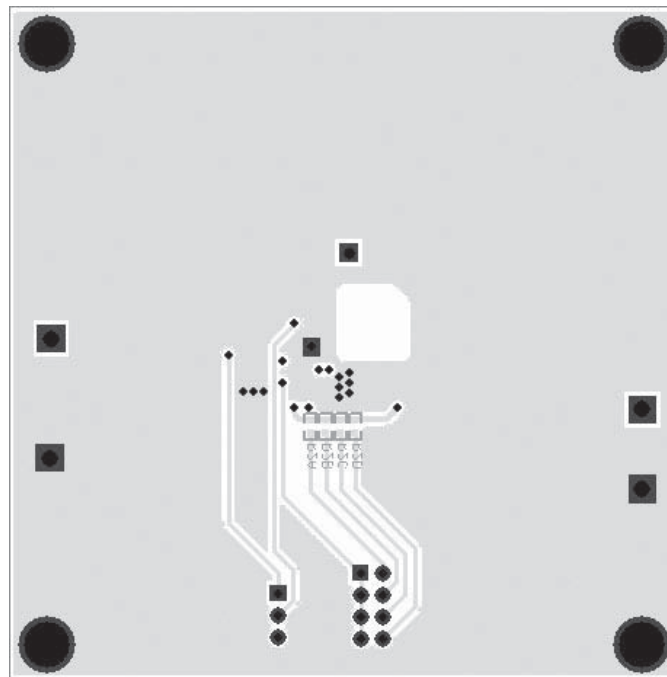

Figure 6: AAT1153 Evaluation Board Solder Side Layout.

Step-Down Converter Design Example

Specifications

$$V_O = 1.8V @ 2A$$

$$V_{IN} = 2.7V \text{ to } 4.2V \text{ (3.6V nominal)}$$

$$f_S = 1.2MHz$$

$$\text{Transient droop} = 200mV$$

$$\Delta V_O = 50mV$$

1.8V Output Inductor

$$\Delta I_L = 30\% \cdot I_O = 0.3 \cdot 2 = 600mA$$

$$L = \frac{V_{OUT} \cdot (V_{IN(MAX)} - V_{OUT})}{V_{IN(MAX)} \cdot \Delta I_L \cdot f_{OSC}} = \frac{1.8 \cdot (4.2 - 1.8)}{4.2 \cdot 0.6 \cdot 1.2 \cdot 10^6} = 1.4\mu H$$

For Sumida 2.2μH inductor (CDRH2D14) with DCR 75mΩ, the ΔI_L should be

$$\Delta I_L = \frac{V_O}{L} \cdot \left(1 - \frac{V_O}{V_{IN}}\right) \cdot T = 395mA$$

$$I_{PKL} = I_O + \frac{\Delta I_L}{2} = 2 + \frac{0.395}{2} = 2.2A$$

$$P_L = I_O^2 \cdot DCR = 2^2 \cdot 0.0287 = 114.8mW$$

1.8V Output Capacitor

$$C_{OUT} = \frac{3 \cdot \Delta I_{LOAD}}{V_{DROOP} \cdot f_S} = \frac{3 \cdot 1.2}{0.2 \cdot 1.2 \cdot 10^6} = 25\mu F; \text{ use } 22\mu F$$

$$ESR \leq \frac{\Delta V_O}{\Delta I_L} = \frac{0.05}{0.395} = 0.13\Omega$$

Select a 22μF, 10mΩ ESR ceramic capacitor to meet the ripple 50mV requirement.

$$\begin{aligned} \Delta V_{OUT} &\leq \frac{V_{OUT} \cdot (V_{IN} - V_{OUT})}{V_{IN} \cdot f_{OSC} \cdot L} \cdot \left(ESR + \frac{1}{8 \cdot f_{OSC} \cdot C_{OUT}}\right) \\ &= \frac{1.8 \cdot (4.2 - 1.8)}{4.2 \cdot 1.2 \cdot 10^6 \cdot 2.2 \cdot 10^{-6}} \cdot \left(0.01 + \frac{1}{8 \cdot 1.2 \cdot 10^6 \cdot 22 \cdot 10^{-6}}\right) = 5.7mV \end{aligned}$$

$$I_{RMS} = \Delta I_L \cdot 0.289 = 0.395 \cdot 0.289 = 114mA_{RMS}$$

$$P_{COUT} = ESR \cdot I_{RMS}^2 = 0.01 \cdot 1^2 = 10mW$$

Input Capacitor

Input ripple $V_{pp} = 25\text{mV}$

$$C_{IN(MIN)} = \frac{1}{\left(\frac{V_{PP}}{I_O} - ESR\right) \cdot 4 \cdot f_s} = \frac{1}{\left(\frac{0.025}{2} - 0.01\right) \cdot 4 \cdot 1.2 \cdot 10^6} = 13.9\mu\text{F}; \text{ use } 22\mu\text{F}$$

$$I_{RMS} = \frac{I_O}{2} = \frac{2}{2} = 1\text{Arms}$$

$$P_{CIN} = ESR \cdot I_{RMS}^2 = 0.01 \cdot 1^2 = 10\text{mW}$$

AAT1153 Losses

$$P_{TOTAL} = I_O^2 \cdot R_{DS(ON)P} \cdot D + I_O^2 \cdot R_{DS(ON)N} \cdot (1 - D) + (t_{SW} \cdot f_s \cdot I_O) \cdot V_{IN}$$

$$= 2^2 \cdot 0.135 \cdot \frac{1.8}{4.2} + 2^2 \cdot 0.095 \cdot \left(1 - \frac{1.8}{4.2}\right) + (5 \cdot 10^{-9} \cdot 1.2 \cdot 10^6 \cdot 2) \cdot 4.2 = 498.9\text{mW}$$

Ordering Information

Output Voltage	Package	Marking ¹	Part Number (Tape and Reel) ²
Adj. 0.6V to V_{IN}	TDFN33-10	ZSXY	AAT1153IDE-0.6-T1
Fixed 1.8V	TDFN33-10	ZTXYY	AAT1153IDE-1.8-T1



All AnalogicTech products are offered in Pb-free packaging. The term “Pb-free” means semiconductor products that are in compliance with current RoHS standards, including the requirement that lead not exceed 0.1% by weight in homogeneous materials. For more information, please visit our website at <http://www.analogictech.com/pbfree>.

Package Information³

TDFN33-10

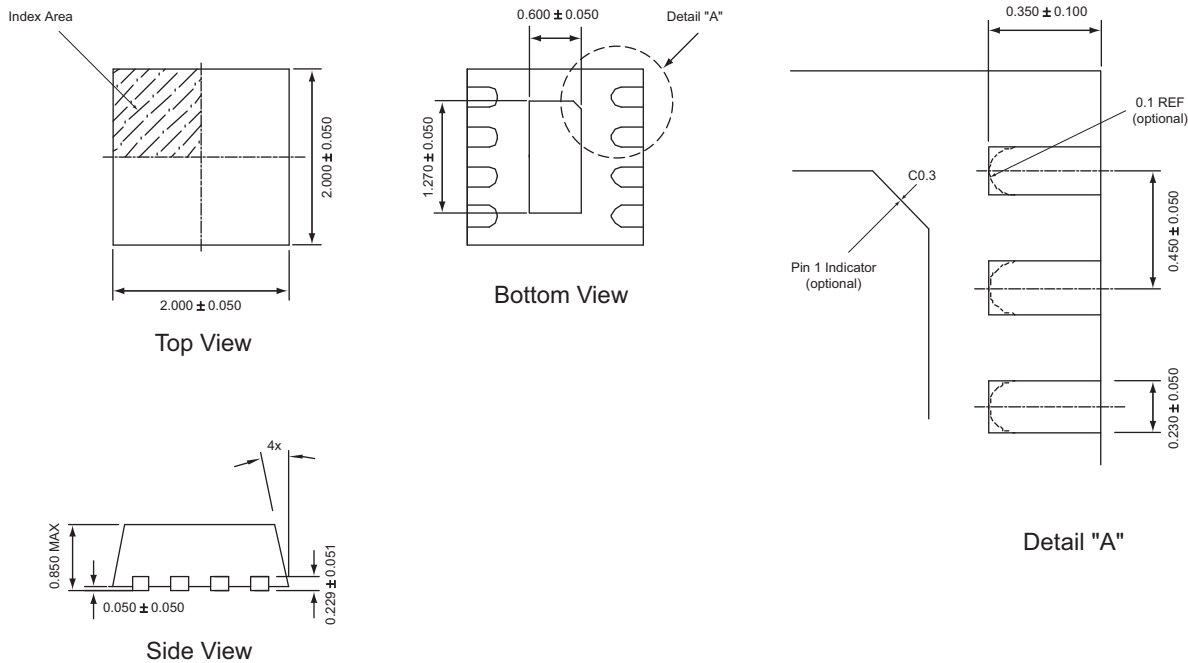

All dimensions in millimeters.

1. XYY = assembly and date code.
 2. Sample stock is generally held on all part numbers listed in BOLD.
 3. The leadless package family, which includes QFN, TQFN, DFN, TDFN and STDFN, has exposed copper (unplated) at the end of the lead terminals due to the manufacturing process. A solder fillet at the exposed copper edge cannot be guaranteed and is not required to ensure a proper bottom solder connection.

Advanced Analogic Technologies, Inc.
3230 Scott Boulevard, Santa Clara, CA 95054
Phone (408) 737-4600
Fax (408) 737-4611



© Advanced Analogic Technologies, Inc.
AnalogicTech cannot assume responsibility for use of any circuitry other than circuitry entirely embodied in an AnalogicTech product. No circuit patent licenses, copyrights, mask work rights, or other intellectual property rights are implied. AnalogicTech reserves the right to make changes to their products or specifications or to discontinue any product or service without notice. Except as provided in AnalogicTech's terms and conditions of sale, AnalogicTech assumes no liability whatsoever, and AnalogicTech disclaims any express or implied warranty relating to the sale and/or use of AnalogicTech products including liability or warranties relating to fitness for a particular purpose, merchantability, or infringement of any patent, copyright or other intellectual property right. In order to minimize risks associated with the customer's applications, adequate design and operating safeguards must be provided by the customer to minimize inherent or procedural hazards. Testing and other quality control techniques are utilized to the extent AnalogicTech deems necessary to support this warranty. Specific testing of all parameters of each device is not necessarily performed. AnalogicTech and the AnalogicTech logo are trademarks of Advanced Analogic Technologies Incorporated. All other brand and product names appearing in this document are registered trademarks or trademarks of their respective holders.