

# EE-SPY31/41

## Accurately detects objects placed in front of shiny Background.

- A shiny background can be used as long as the distance between the sensor and the background is 20 mm or more.
- Detects minute objects such as a 0.05-mm-dia. pure copper wire.
- Small dispersion in sensing distance.
- Light modulation effectively reduces external light interference.
- Wide operating voltage range: 5 to 24 VDC





 Be sure to read *Safety Precautions* on page 4.

## Ordering Information

### Sensors

 Infrared light

Appearance	Sensing method	Sensing distance		Output type	Output configuration	Model
Horizontal type 	Convergent reflective type		2 to 5 mm	NPN output	Dark-ON	EE-SPY311
Vertical type 					Light-ON	EE-SPY411
					Dark-ON	EE-SPY312
					Light-ON	EE-SPY412

### Accessories (Order Separately)

Type	Cable length	Model	
Connector		EE-1001	
		EE-1009	
	Connector with Cable	1 m	EE-1006
			EE-1010
		2 m	EE-1006
		EE-1010	
	Connector with Robot Cable	1 m	EE-1010-R
2 m		EE-1010-R	
NPN/PNP Conversion Connector	0.46 m (total length)	EE-2002	

\* Refer to *Accessories* for details.

Ratings and Specifications

Item	Models	EE-SPY311, EE-SPY411, EE-SPY312, EE-SPY412
Sensing distance		2 to 5 mm (Reflection factor: 90%; white paper 15 × 15 mm)
Minimum sensing object		Pure copper wire (0.05 mm dia.)
Distance to background *1		20 mm max. (glass with aluminum deposition)
Differential distance		0.2 mm (with a sensing distance of 3 mm, horizontally)
Light source		GaAs infrared LED with a peak wavelength of 940 nm
Indicator *2		Light indicator (red)
Supply voltage		5 to 24 VDC ±10%, ripple (p-p): 5% max.
Current consumption		Average: 15 mA max., Peak: 50 mA max.
Control output		NPN voltage output: Load power supply voltage: 5 to 24 VDC Load current: 80 mA max. OFF current: 0.5 mA max. 80 mA load current with a residual voltage of 1.0 V max. 10 mA load current with a residual voltage of 0.4 V max.
Response frequency *3		100 Hz min.
Ambient illumination		3,000 lx max. with incandescent light or sunlight on the surface of the receiver
Ambient temperature range		Operating: -10 to +55°C Storage: -25 to +65°C
Ambient humidity range		Operating: 5% to 85% Storage: 5% to 95%
Vibration resistance		Destruction: 10 to 50 Hz, 1.5-mm double amplitude for 2 h each in X, Y, and Z directions
Shock resistance		Destruction: 500m/s <sup>2</sup> for 3 times each in X, Y, and Z directions
Degree of protection		IEC IP50
Connecting method		Special connector (soldering not possible)
Weight		Approx. 2.6 g
Material	Case	Polycarbonate
	Holder	Polybutylene phthalate (PBT)

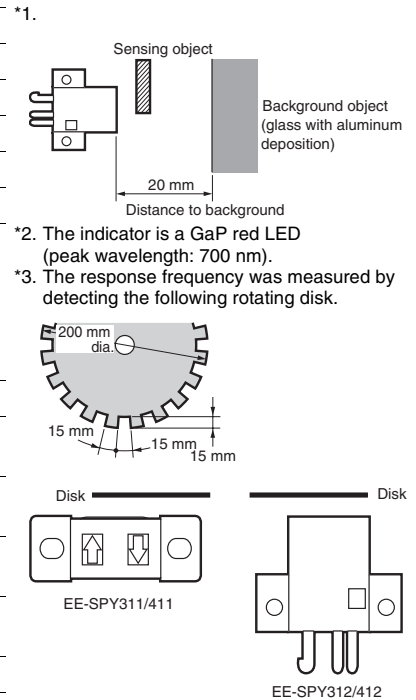

I/O Circuit Diagrams

NPN Output

Model	Output configuration	Timing charts	Output circuit
EE-SPY411 EE-SPY412	Light-ON		<p>* Voltage output (when the sensor is connected to a transistor circuit)</p>
EE-SPY311 EE-SPY312	Dark-ON		

Engineering Data (Typical)

Operating Range Characteristics

EE-SPY311/411

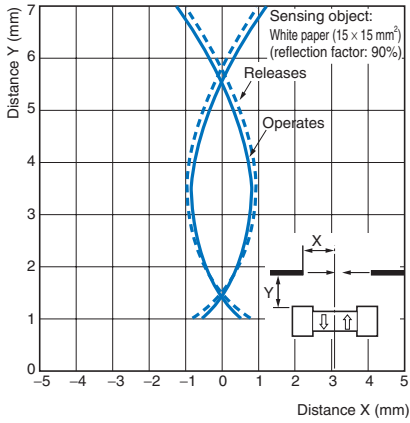

EE-SPY311/411

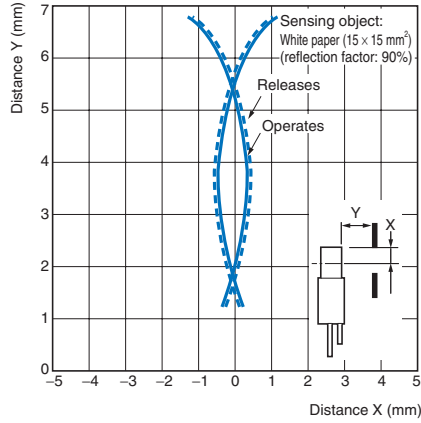

EE-SPY312/412

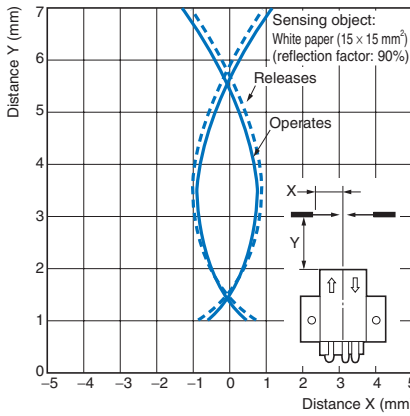

EE-SPY312/412

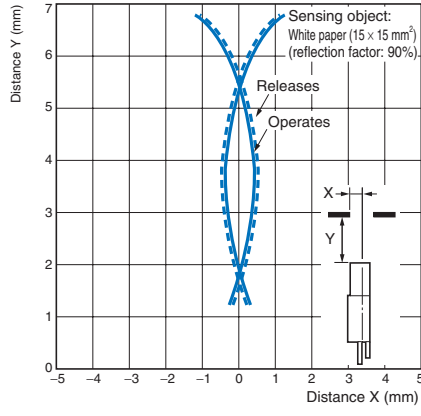

Sensing Distance vs. Object Area Characteristics

EE-SPY□□□□

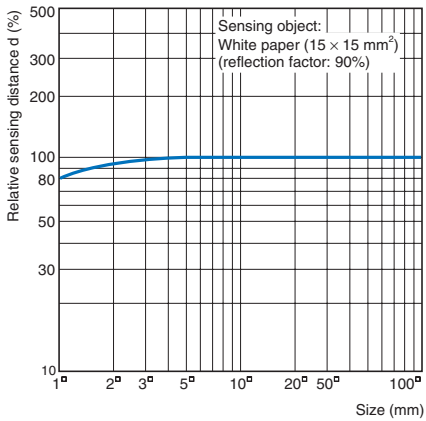

Sensing Angle vs. Sensing Distance Characteristics

EE-SPY312/412

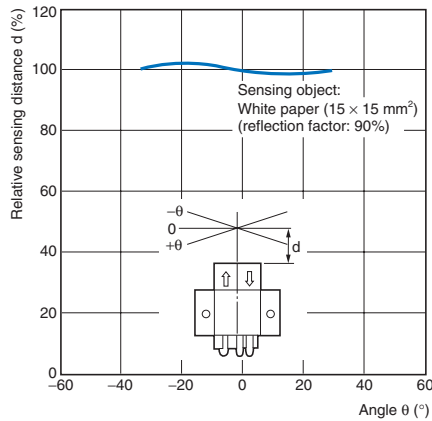

Receiver Output vs. Sensing Distance Characteristics

EE-SPY□□□□

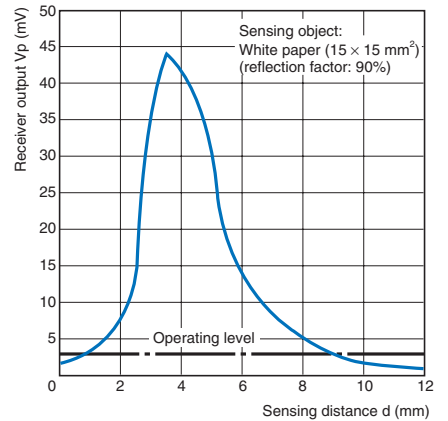

## Safety Precautions

Refer to *Warranty and Limitations of Liability*.

**⚠ WARNING**

This product is not designed or rated for ensuring safety of persons either directly or indirectly. Do not use it for such purposes.



**Precautions for Correct Use**

Make sure that this product is used within the rated ambient environment conditions.

● **Wiring**

- Connection is made using a connector. Do not solder to the pins (leads).

- When extending the cable, use an extension cable with conductors having a total cross-section area of 0.3 mm<sup>2</sup>. The total cable length must be 2 m maximum.
- To use a cable length longer than 2 m, attach a capacitor with a capacitance of approximately 10 μF to the wires as shown below. The distance between the terminal and the capacitor must be within 2 m. (Use a capacitor with a dielectric strength that is at least twice the Sensor's power supply voltage.)

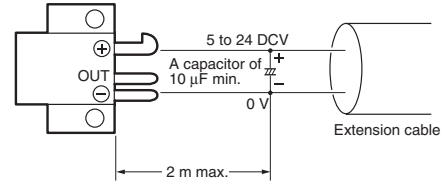

- Make sure the total length of the power cable connected to the product is less than 10 m even if a capacitor is inserted.

(Unit: mm)

## Dimensions

Tolerance class IT16 applies to dimensions in this datasheet unless otherwise specified.

### Sensors

EE-SPY311  
EE-SPY411

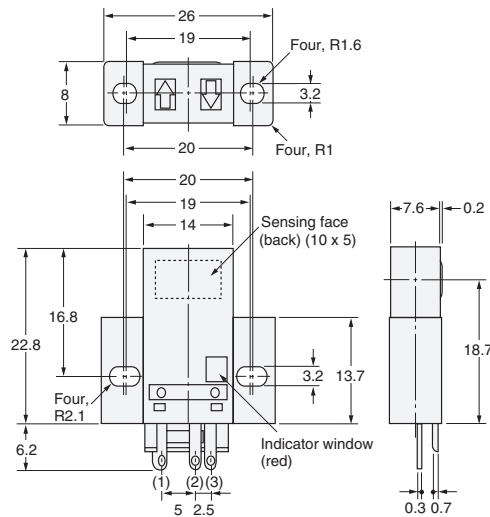
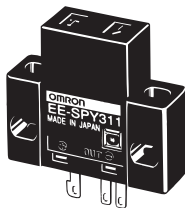

**Terminal Arrangement**

(1)	+	V <sub>CC</sub>
(2)	OUT	OUTPUT
(3)	-	GND (0 V)

EE-SPY312  
EE-SPY412

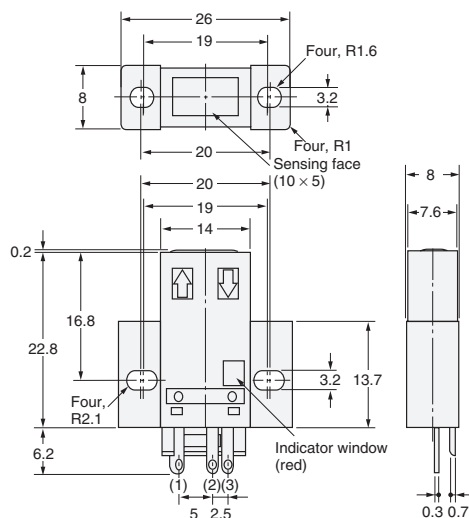
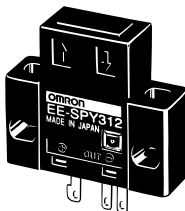

**Terminal Arrangement**

(1)	+	V <sub>CC</sub>
(2)	OUT	OUTPUT
(3)	-	GND (0 V)

### Accessories (Order Separately)

\* Refer to *Accessories* for details.

## Read and Understand This Catalog

Please read and understand this catalog before purchasing the products. Please consult your OMRON representative if you have any questions or comments.

## Warranty and Limitations of Liability

### WARRANTY

OMRON's exclusive warranty is that the products are free from defects in materials and workmanship for a period of one year (or other period if specified) from date of sale by OMRON.

OMRON MAKES NO WARRANTY OR REPRESENTATION, EXPRESS OR IMPLIED, REGARDING NON-INFRINGEMENT, MERCHANTABILITY, OR FITNESS FOR PARTICULAR PURPOSE OF THE PRODUCTS. ANY BUYER OR USER ACKNOWLEDGES THAT THE BUYER OR USER ALONE HAS DETERMINED THAT THE PRODUCTS WILL SUITABLY MEET THE REQUIREMENTS OF THEIR INTENDED USE. OMRON DISCLAIMS ALL OTHER WARRANTIES, EXPRESS OR IMPLIED.

### LIMITATIONS OF LIABILITY

OMRON SHALL NOT BE RESPONSIBLE FOR SPECIAL, INDIRECT, OR CONSEQUENTIAL DAMAGES, LOSS OF PROFITS OR COMMERCIAL LOSS IN ANY WAY CONNECTED WITH THE PRODUCTS, WHETHER SUCH CLAIM IS BASED ON CONTRACT, WARRANTY, NEGLIGENCE, OR STRICT LIABILITY.

In no event shall the responsibility of OMRON for any act exceed the individual price of the product on which liability is asserted.

IN NO EVENT SHALL OMRON BE RESPONSIBLE FOR WARRANTY, REPAIR, OR OTHER CLAIMS REGARDING THE PRODUCTS UNLESS OMRON'S ANALYSIS CONFIRMS THAT THE PRODUCTS WERE PROPERLY HANDLED, STORED, INSTALLED, AND MAINTAINED AND NOT SUBJECT TO CONTAMINATION, ABUSE, MISUSE, OR INAPPROPRIATE MODIFICATION OR REPAIR.

## Application Considerations

### SUITABILITY FOR USE

OMRON shall not be responsible for conformity with any standards, codes, or regulations that apply to the combination of products in the customer's application or use of the products.

At the customer's request, OMRON will provide applicable third party certification documents identifying ratings and limitations of use that apply to the products. This information by itself is not sufficient for a complete determination of the suitability of the products in combination with the end product, machine, system, or other application or use.

The following are some examples of applications for which particular attention must be given. This is not intended to be an exhaustive list of all possible uses of the products, nor is it intended to imply that the uses listed may be suitable for the products:

- Outdoor use, uses involving potential chemical contamination or electrical interference, or conditions or uses not described in this catalog.
- Nuclear energy control systems, combustion systems, railroad systems, aviation systems, medical equipment, amusement machines, vehicles, safety equipment, and installations subject to separate industry or government regulations.
- Systems, machines, and equipment that could present a risk to life or property.

Please know and observe all prohibitions of use applicable to the products.

NEVER USE THE PRODUCTS FOR AN APPLICATION INVOLVING SERIOUS RISK TO LIFE OR PROPERTY WITHOUT ENSURING THAT THE SYSTEM AS A WHOLE HAS BEEN DESIGNED TO ADDRESS THE RISKS, AND THAT THE OMRON PRODUCTS ARE PROPERLY RATED AND INSTALLED FOR THE INTENDED USE WITHIN THE OVERALL EQUIPMENT OR SYSTEM.

### PROGRAMMABLE PRODUCTS

OMRON shall not be responsible for the user's programming of a programmable product, or any consequence thereof.

## Disclaimers

### CHANGE IN SPECIFICATIONS

Product specifications and accessories may be changed at any time based on improvements and other reasons.

It is our practice to change model numbers when published ratings or features are changed, or when significant construction changes are made. However, some specifications of the products may be changed without any notice. When in doubt, special model numbers may be assigned to fix or establish key specifications for your application on your request. Please consult with your OMRON representative at any time to confirm actual specifications of purchased products.

### DIMENSIONS AND WEIGHTS

Dimensions and weights are nominal and are not to be used for manufacturing purposes, even when tolerances are shown.

### PERFORMANCE DATA

Performance data given in this catalog is provided as a guide for the user in determining suitability and does not constitute a warranty. It may represent the result of OMRON's test conditions, and the users must correlate it to actual application requirements. Actual performance is subject to the OMRON Warranty and Limitations of Liability.

### ERRORS AND OMISSIONS

The information in this document has been carefully checked and is believed to be accurate; however, no responsibility is assumed for clerical, typographical, or proofreading errors, or omissions.

2008.11

In the interest of product improvement, specifications are subject to change without notice.

**OMRON Corporation**  
Industrial Automation Company

<http://www.ia.omron.com/>

(c)Copyright OMRON Corporation 2008 All Right Reserved.