

SMD ■ REFLECTOR 67-03/RSGHBHC-B06/1T

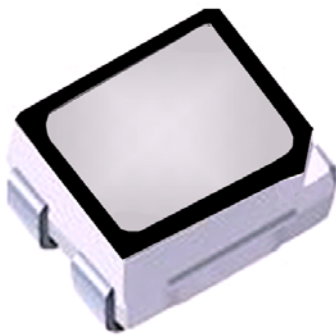

Features

- P-LCC-4 package.
- White package and black surface.
- Optical indicator.
- Ideal for backlight and light pipe application.
- Wide viewing angle.
- Suitable for vapor-phase reflow, Infrared reflow and wave solder processes.
- Computable with automatic placement equipment.
- Available on tape and reel (8mm Tape).
- Pb-free.
- The product itself will remain with RoHS compliant version

Description

The 67-03 series is available in soft orange, green, blue, and yellow. Due to the package design, the LED has wide viewing angle and optimized light coupling by inter reflector. This feature makes the LED ideal for light pipe application. The low current requirement makes this device ideal for portable equipment or any other application where power is at a premium.

Applications

- Telecommunication: indicator and backlighting in telephone and fax.
- Flat backlight for LCD's, switches and symbols.
- Light pipe application.
- General use.

Device Selection Guide

Chip Materials	Emitted Color	Resin Color
AlGaInP	Brilliant Red	Water Clear
InGaN	Brilliant Green	
InGaN	Blue	

Absolute Maximum Ratings (Ta=25°C)

Parameter	Symbol	Rating	Unit
Reverse Voltage	V_R	5	V
Forward Current	I_F	RS:50 GH:30 BH:30	mA
Peak Forward Current (Duty 1/10 @1KHz)	I_{FP}	RS:100 GH:100 BH:100	mA
Power Dissipation	P_d	RS:120 GH:110 BH:110	mW
Total Power Dissipation	P_{tot}	340	mW
Operating Temperature	T_{opr}	-40 ~ +85	°C
Storage Temperature	T_{stg}	-40 ~ +90	°C
ESD (Classification acc. AEC Q101)	ESD_{HBM}	RS:2000 GH:1000 BH:1000	V
Soldering Temperature	T_{sol}	Reflow Soldering : 260 °C for 10 sec. Hand Soldering : 350 °C for 3 sec.	

Electro-Optical Characteristics (Ta=25°C)

Parameter	Symbol		Min.	Typ.	Max.	Unit	Condition
Luminous Intensity	Iv	RS	450.0	-----	715.0	mcd	I _F =20mA
		GH	900.0	-----	1420.0		
		BH	225.0	-----	450.0		
Viewing Angle	2θ _{1/2}		-----	120	-----	deg	I _F =20mA
Peak Wavelength	λ _p	RS		632		nm	I _F =20mA
		GH	-----	518	-----		
		BH		468			
Dominant Wavelength	λ _d	RS	617.0		627.0	nm	I _F =20mA
		GH	520.0	-----	530.0		
		BH	465.0		470.0		
Spectrum Radiation Bandwidth	Δλ	RS		25		nm	I _F =20mA
		GH	-----	35	-----		
		BH		35			
Forward Voltage	V _F	RS	---	2.0	2.4	v	I _F =20m
		GH	---	3.5	4.0		
		BH	---	3.5	4.0		
Reverse Current	I _R		-----	-----	10	μA	V _R =5V

Note:

1. Tolerance of Luminous Intensity: ±10%
2. Tolerance of Dominant Wavelength: ±1nm
3. Tolerance of Forward Voltage: ±0.1V

Floating Bin(RS)
Bin Range of Luminous Intensity

Symbol	Bin Code	Min.	Max.	Unit	Condition
RS	U1	450.0	565.0	mcd	I _F =20mA
	U2	565.0	715.0		

Bin Range of Dominant Wavelength

Symbol	Bin Code	Min.	Max.	Unit	Condition
RS	1	617.0	622.0	nm	I _F =20mA
	2	622.0	627.0		

Floating Bin(GH)
Bin Range of Luminous Intensity

Symbol	Bin Code	Min.	Max.	Unit	Condition
GH	V2	900.0	1120.0	mcd	I _F =20mA
	W1	1120.0	1420.0		

Bin Range of Dominant Wavelength

Symbol	Bin Code	Min.	Max.	Unit	Condition
GH	X	520.0	525.0	nm	I _F =20mA
	Y	525.0	530.0		

Note:

- 1.Tolerance of Luminous Intensity: ±10%
- 2.Tolerance of Dominant Wavelength: ±1nm
- 3.Tolerance of Forward Voltage: ±0.1V

**Floating Bin(BH)
 Bin Range of Luminous Intensity**

Symbol	Bin Code	Min.	Max.	Unit	Condition
BH	S2	225.0	285.0	mcd	I _F =20mA
	T1	285.0	360.0		
	T2	360.0	450.0		

Bin Range of Dominant Wavelength

Symbol	Bin Code	Min.	Max.	Unit	Condition
BH	X	465.0	470.0	nm	I _F =20mA

Note:

- 1.Tolerance of Luminous Intensity: ±10%
- 2.Tolerance of Dominant Wavelength: ±1nm
- 3.Tolerance of Forward Voltage: ±0.1V

Typical Electro-Optical Characteristics Curves(RS)

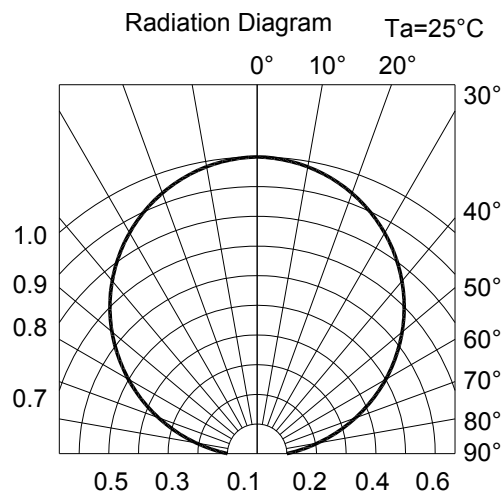
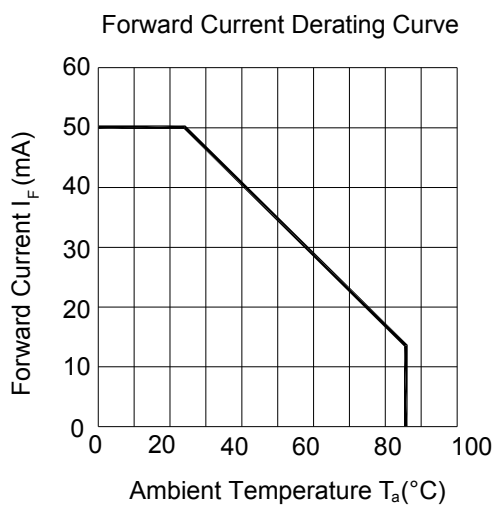
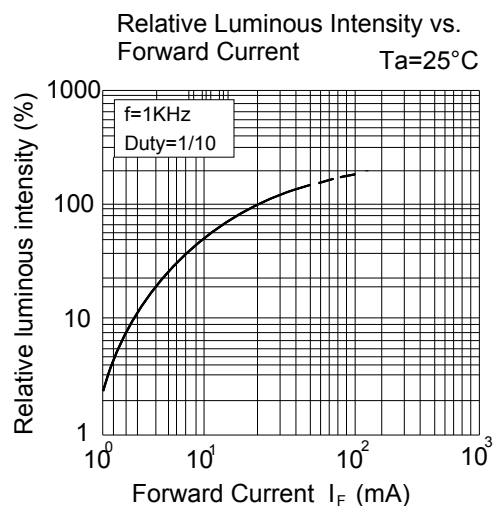
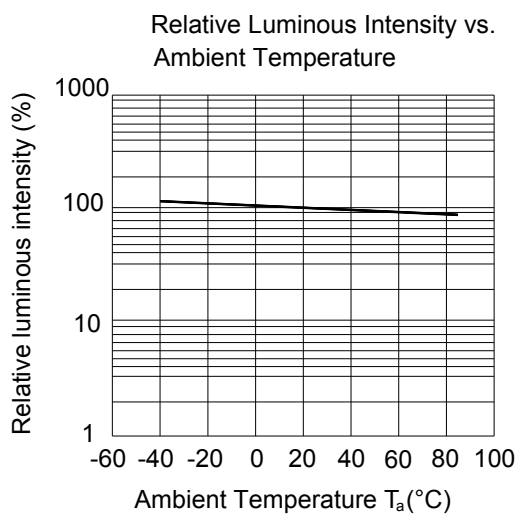
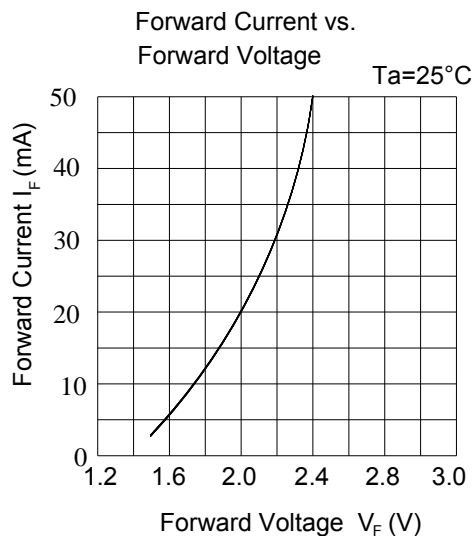
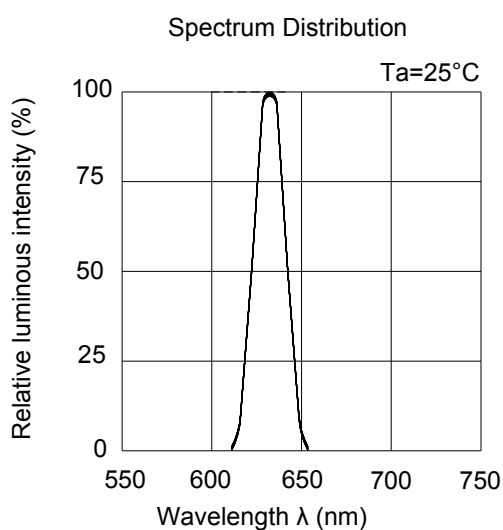

Typical Electro-Optical Characteristics Curves(GH)

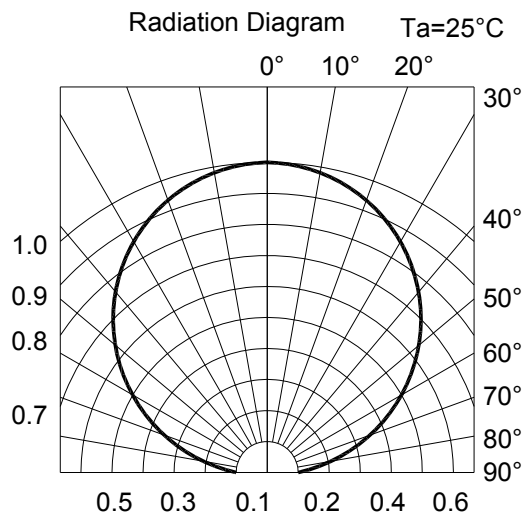
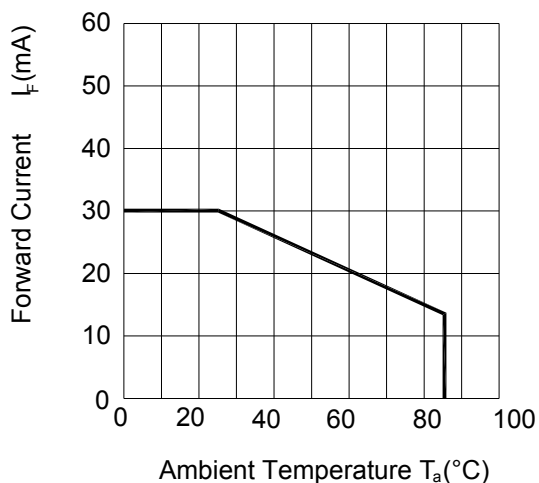
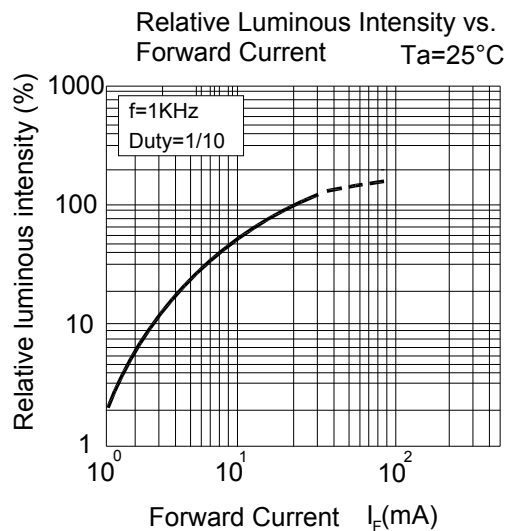
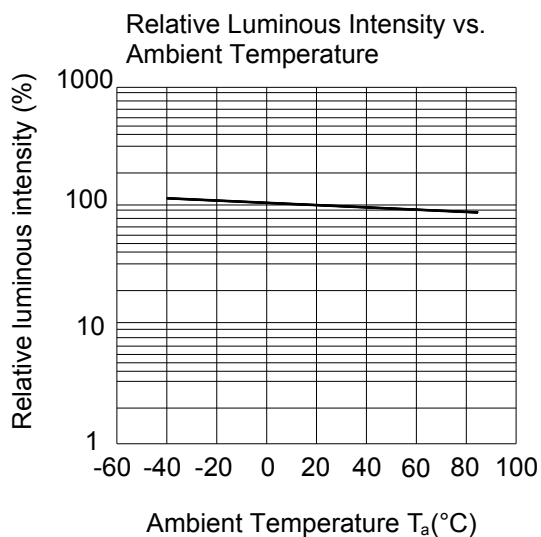
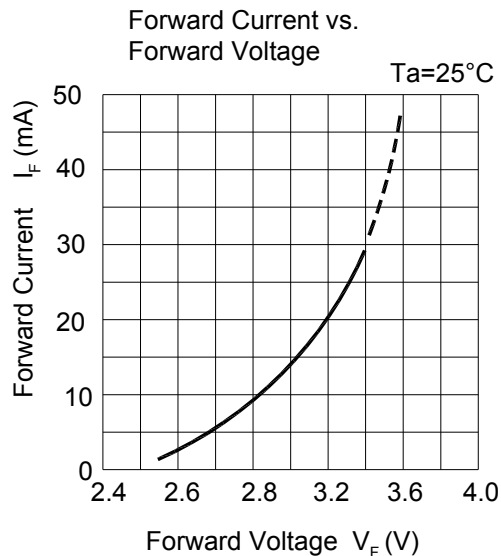
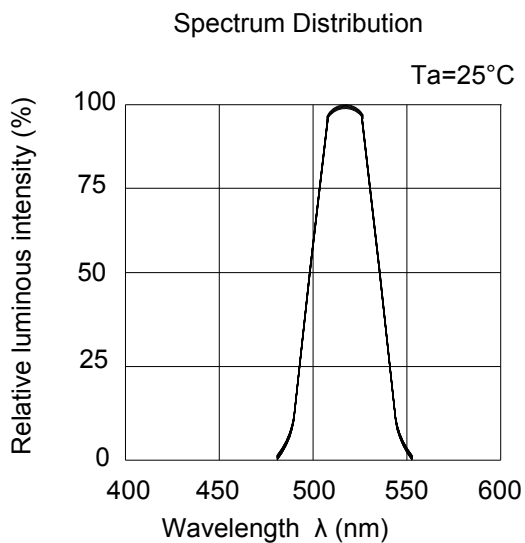

Typical Electro-Optical Characteristics Curves(BH)

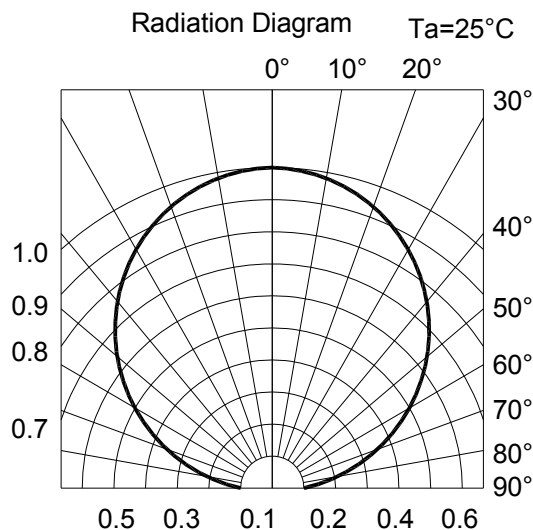
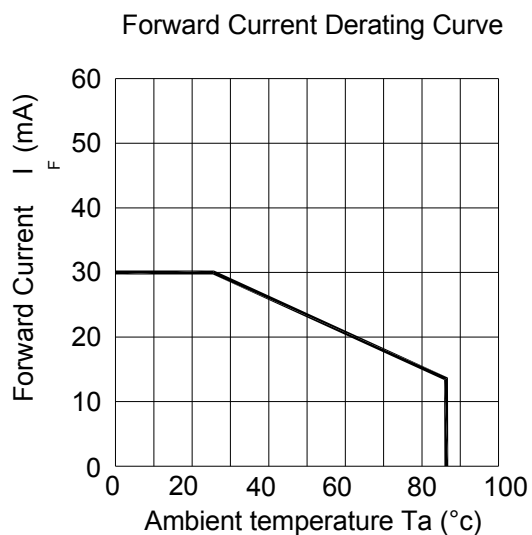
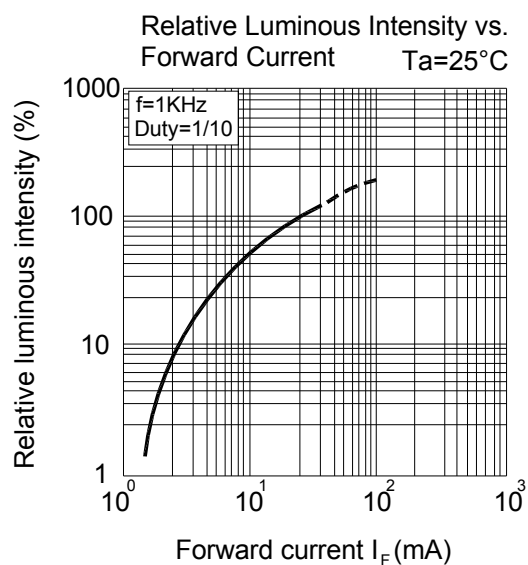
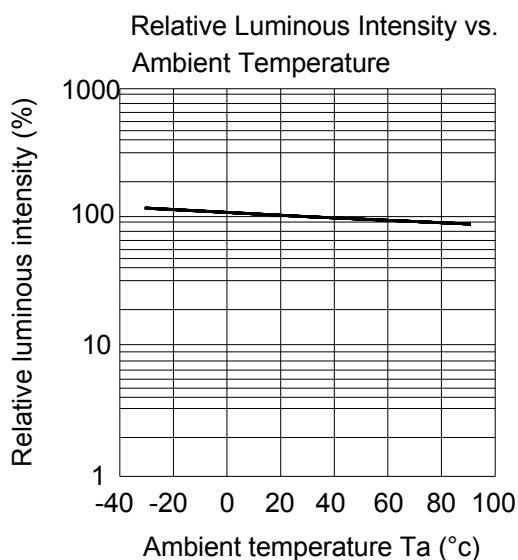
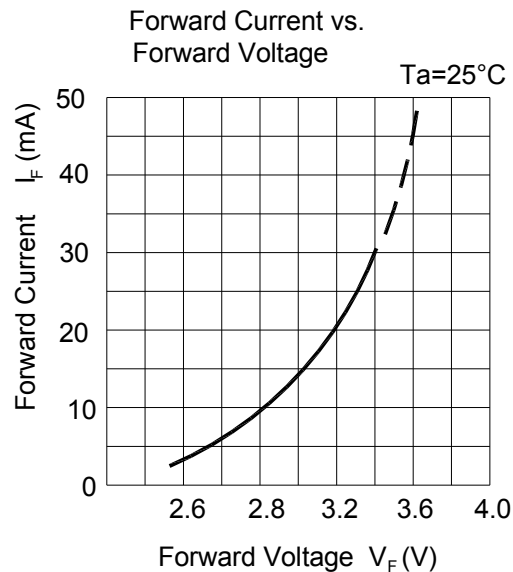
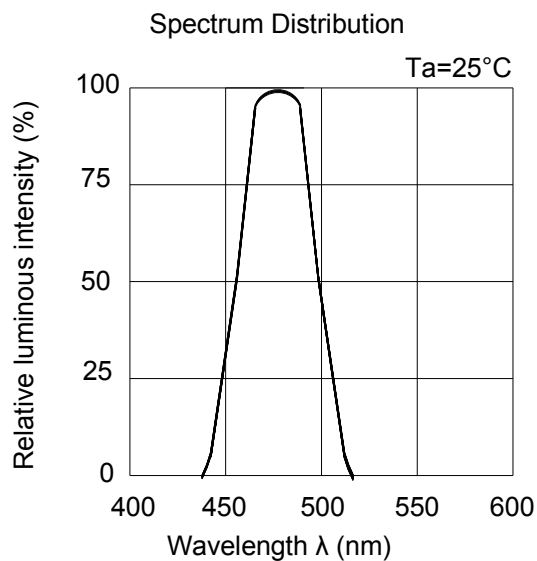

Package Dimension

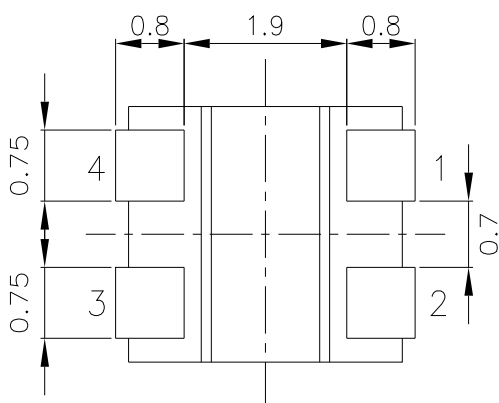
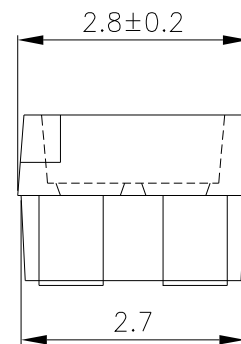
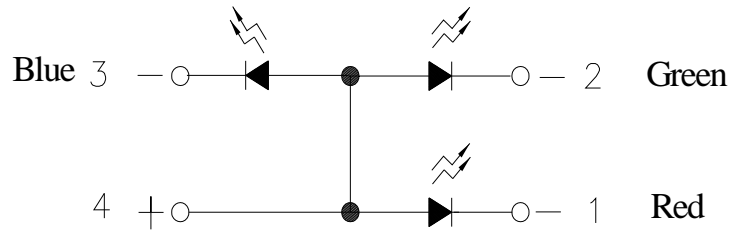
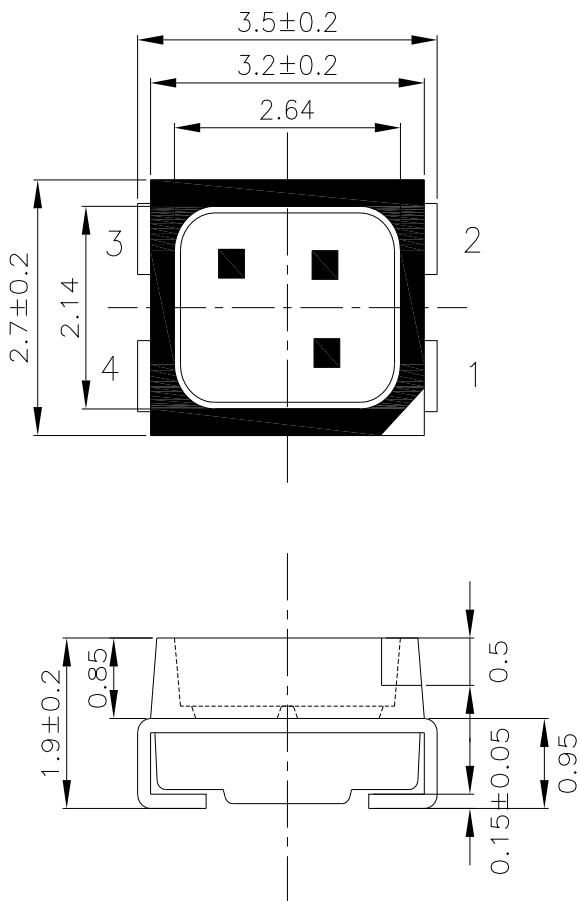

Recommended Solder Pad

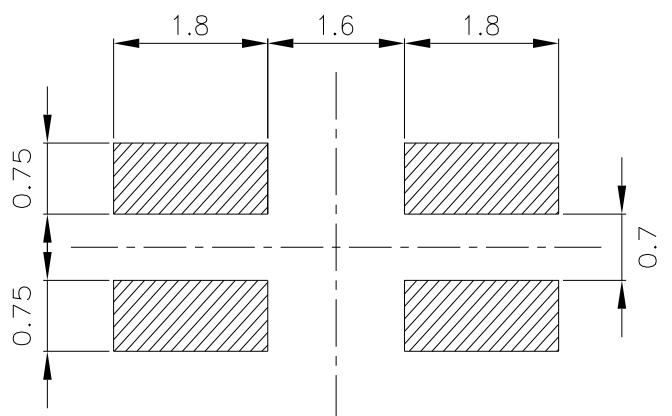

Note: Tolerances unless mentioned $\pm 0.1\text{mm}$. Unit = mm

Moisture Resistant Packing Materials

Label Explanation



- CPN: Customer's Product Number
- P/N: Product Number
- QTY: Packing Quantity
- CAT: Luminous Intensity Rank
- HUE: Dom. Wavelength Rank
- REF: Forward Voltage Rank
- LOT No: Lot Number

Reel Dimensions

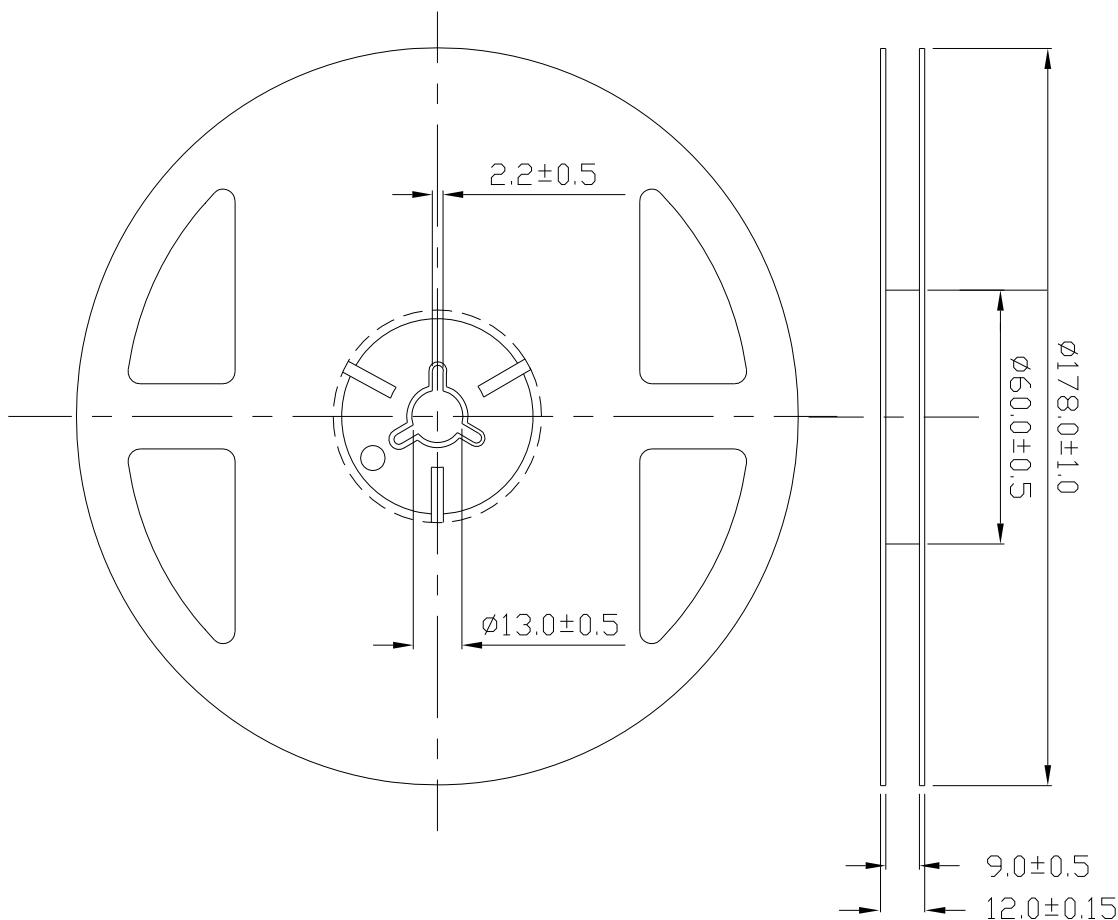

Note: Tolerances unless dimension $\pm 0.1\text{mm}$; Unit = mm

Carrier Tape Dimensions:

Minimum packing amount is 1000 pcs per reel

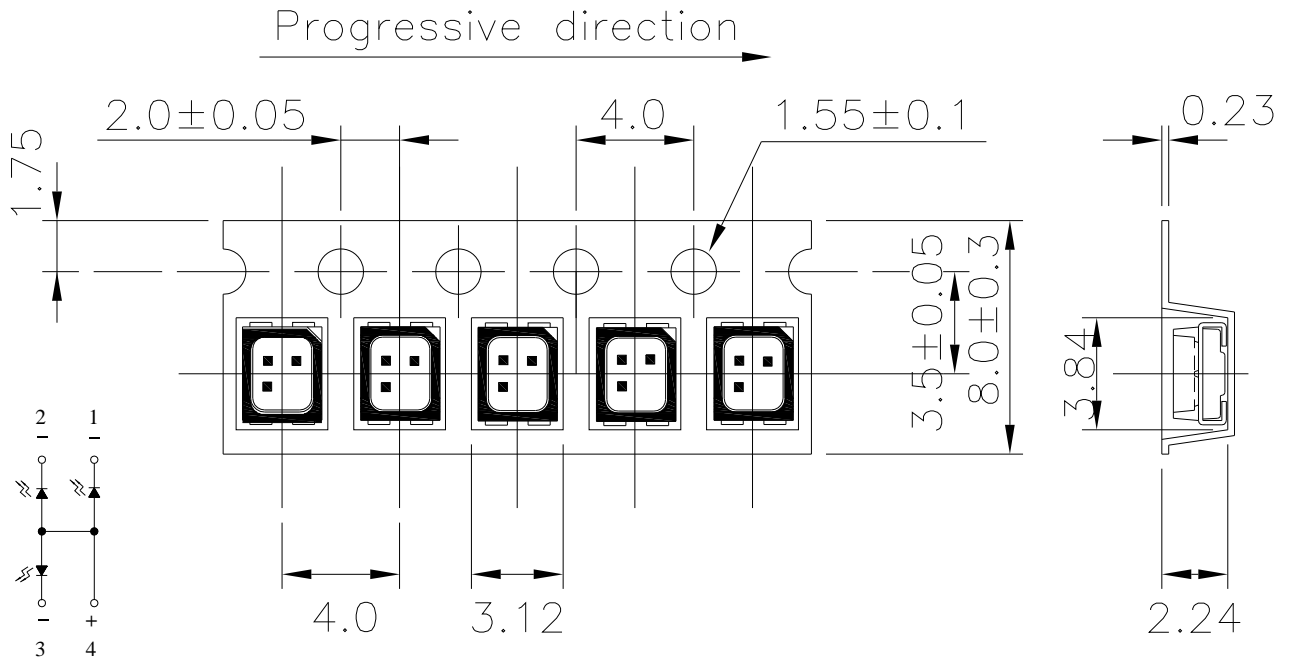

Note: Tolerances unless mentioned ±0.1mm. Unit = mm

Moisture Resistant Packing Process

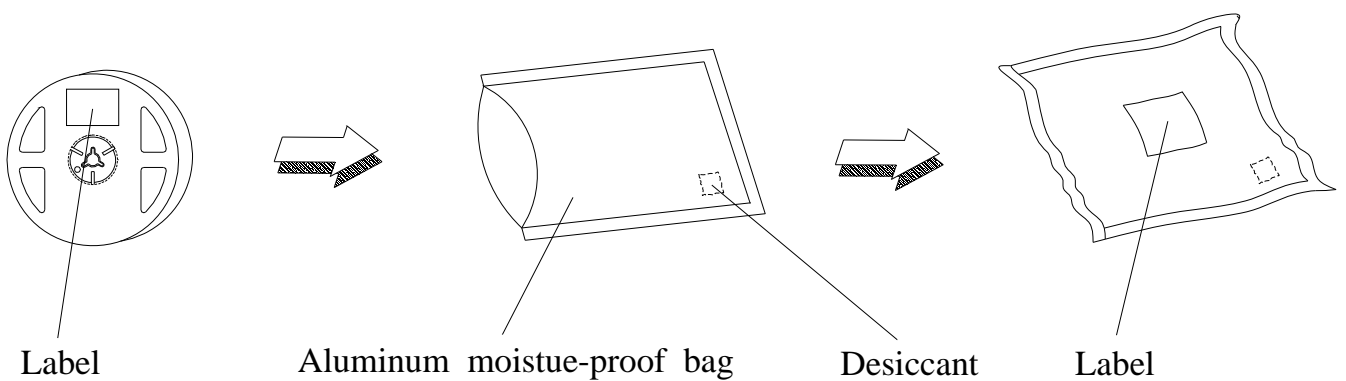

Note: Tolerances unless mentioned ±0.1mm. Unit = mm

Precautions for Use

1. Over-current-proof

Customer must apply resistors for protection, otherwise slight voltage shift will cause big current change (Burn out will happen).

2. Storage

2.1 Do not open moisture proof bag before the products are ready to use.

2.2 Before opening the package: The LEDs should be kept at 30°C or less and 90%RH or less.

2.3 After opening the package: The LED's floor life is 168Hrs under 30°C or less and 60% RH or less. If unused LEDs remain, it should be stored in moisture proof packages.

2.4 If the moisture absorbent material (silica gel) has faded away or the LEDs have exceeded the storage time, baking treatment should be performed using the following conditions.

Baking treatment : 60±5°C for 24 hours.

3. Soldering Condition

3.1 Pb-free solder temperature profile

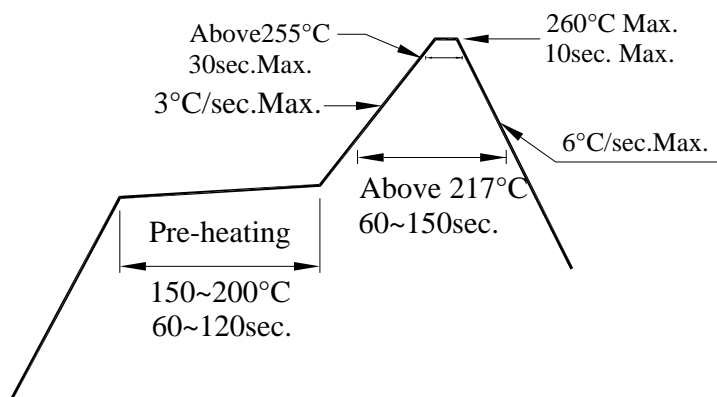

3.2 Reflow soldering should not be done more than two times.

3.3 When soldering, do not put stress on the LEDs during heating.

3.4 After soldering, do not warp the circuit board.

4.Soldering Iron

Each terminal is to go to the tip of soldering iron temperature less than 350°C for 3 seconds within once in less than the soldering iron capacity 25W. Leave two seconds and more intervals, and do soldering of each terminal. Be careful because the damage of the product is often started at the time of the hand solder.

5.Repairing

Repair should not be done after the LEDs have been soldered. When repairing is unavoidable, a double-head soldering iron should be used (as below figure). It should be confirmed beforehand whether the characteristics of the LEDs will or will not be damaged by repairing.

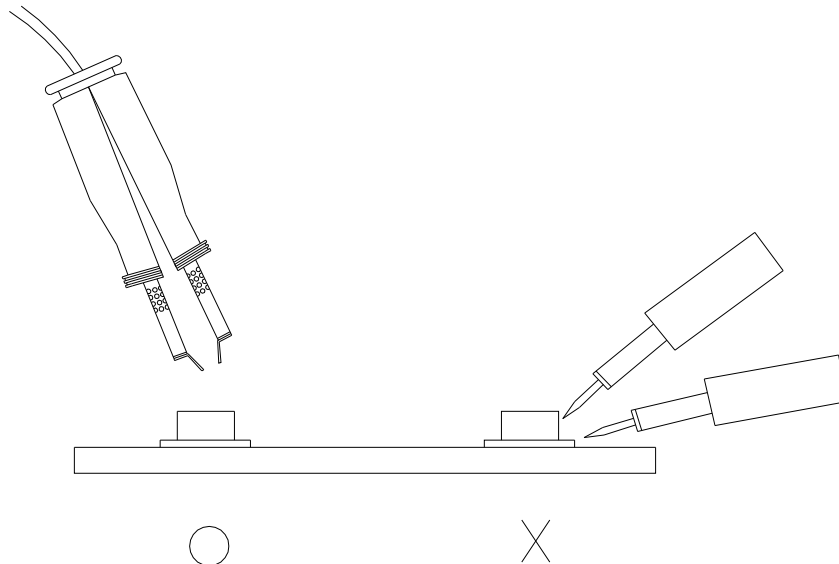

EVERLIGHT ELECTRONICS CO., LTD.
Office: No 6-8, Zhonghua Rd., Shulin Dist.,
New Taipei City 23860, Taiwan, R.O.C

Tel: 886-2-2685-6688
Fax: 886-2-2685-6699
<http://www.everlight.com>