

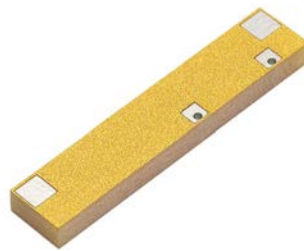

Front



Back

Nemesis

PCS.07.A

Specification

Part No.	PCS.07.A
Product Name	Nemesis Low Profile Cellular SMD Dielectric Antenna GSM / CDMA / DCS / PCS / WCDMA / UMTS /HSDPA / GPRS / EDGE 824~960MHz/1710~2170MHz
Feature	High Efficiency Multi-Band SMD antenna Low profile 35mm * 7mm * 3mm RoHS Compliant

1. Introduction

The PCS.07.A is a low profile SMT cellular antenna designed for direct SMT mount on the device PCB. It provides highest efficiency in very small factor 35*7*3mm. It is more resistant to detuning compared to other antenna integrations. If tuning is required it can be tuned for the

device environment, while there is no need for new tooling. Its rectangular shape and very small size makes it very easy to integrate – can be mounted directly on the edge of the PCB board. The PCS.07 antenna is suitable for lower cost cellular applications and is especially

suitable for telematics and automotive sector. If higher efficiency or improved radiated spurious emissions are required, especially on smaller ground-planes, please use our PA series antennas, PA.25 or PA.710.

2. Specification

Electrical

GSM Band	GSM 850	GSM 900	DCS	PCS	WCDMA I
Frequency (MHz)	824~896	880~960	1710~1880	1850~1990	1920~2170
Peak Gain (dBi)*	-1.96	-1.77	2.90	2.83	2.57
Average Gain (dBi)*	-4.68	-4.44	-2.50	-2.68	-2.42
Efficiency (%)*	32.02	31.06	45.14	52.82	50.11
Return Loss (dB)*	< -3	< -4	< -5	< -7	< -6
Polarization	Linear				
Impedance	50 Ω				

Mechanical

Antenna Dimensions	35mm x 7mm x 3mm
Material	Polymer
Soldering Type	SMT through Reflow

Environmental

Operation Temperature	-40°C ~ +85°C
Storage Temperature	-40°C ~ +85°C

* All measurements taken on 100mm length ground plane EVB board.

3. Antenna Characteristics

3.1 Return Loss

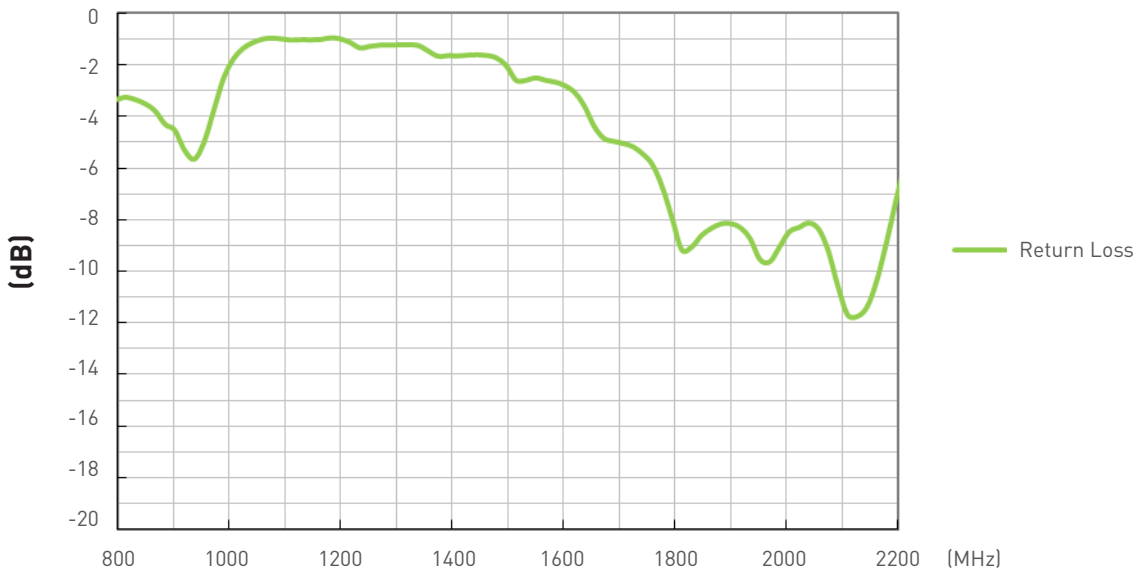

3.2 Maximum Gain

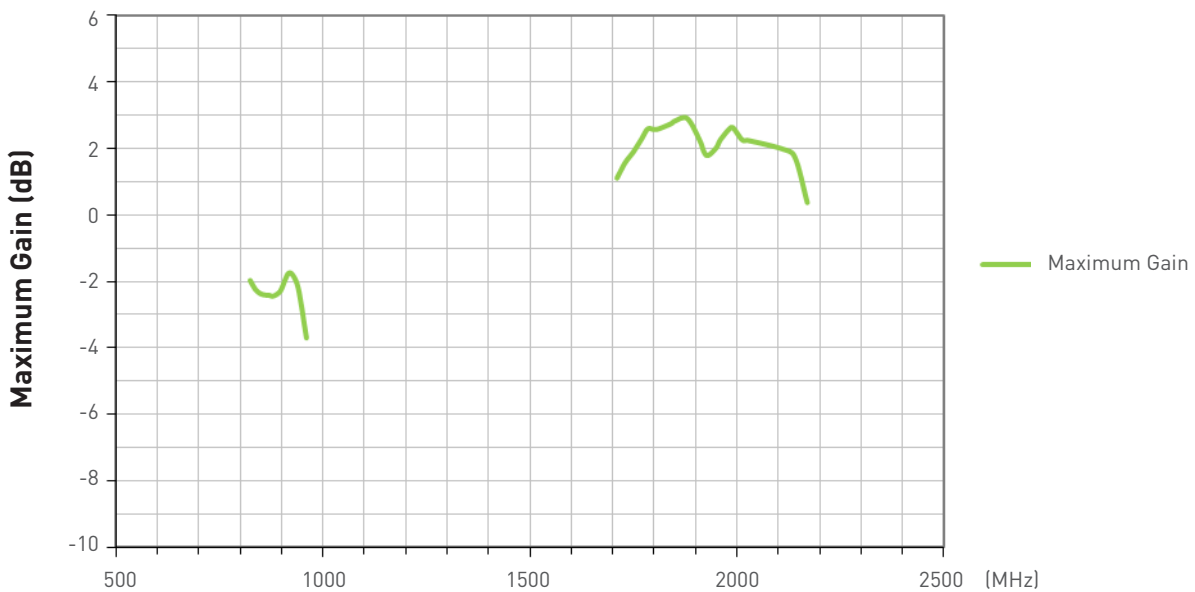

3. Antenna Characteristics

3.3 Average Gain

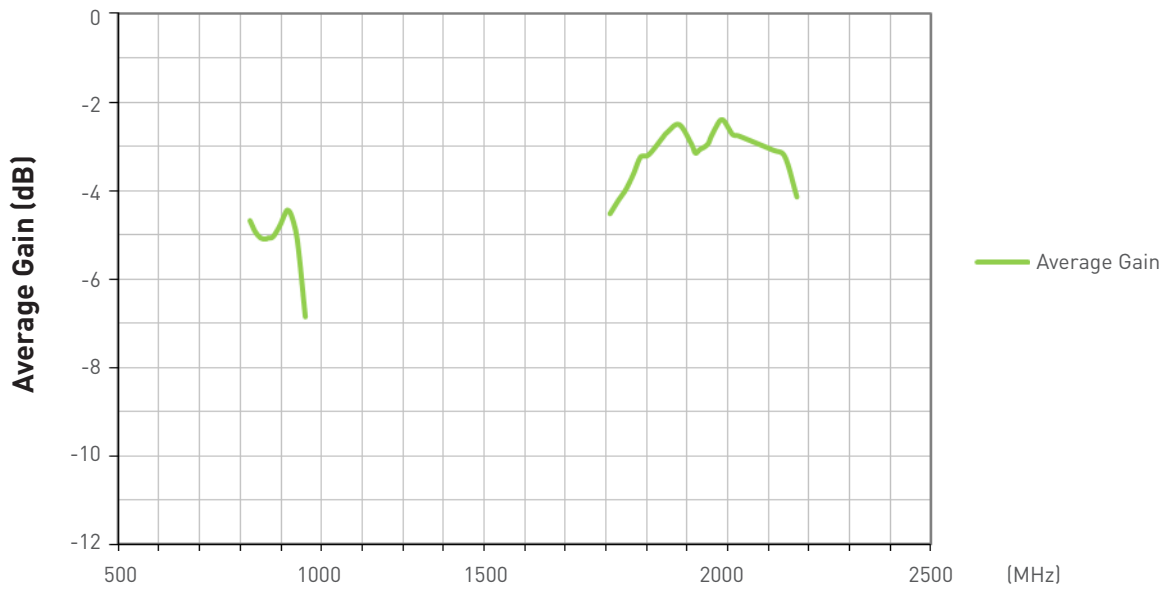

3.4 Efficiency

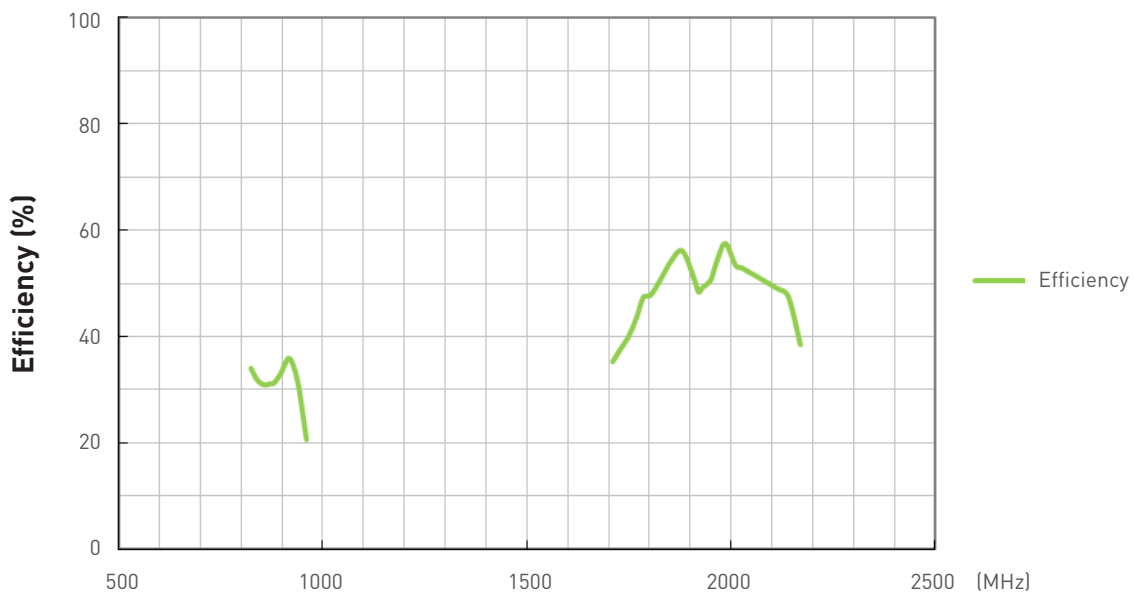

4. Radiation Patterns

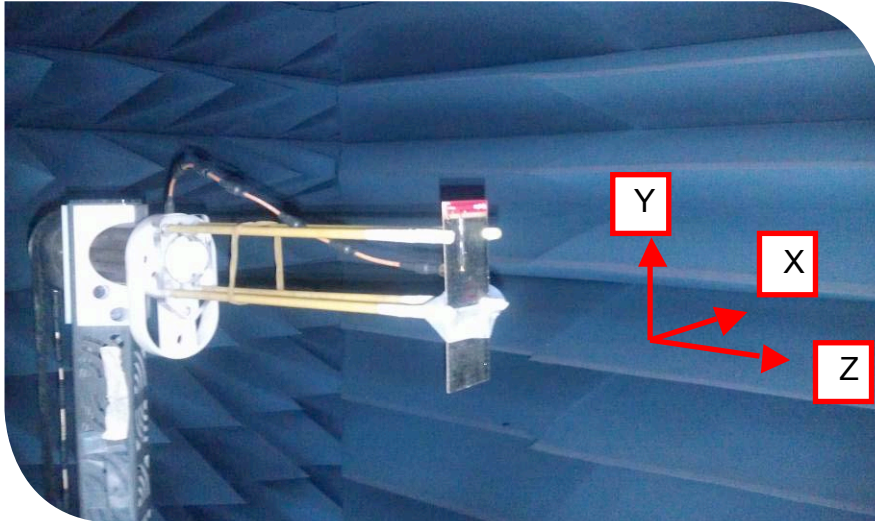

PCSD.07.A - Evaluation Board of PCS.07.A

Radiation patterns

XY Plane

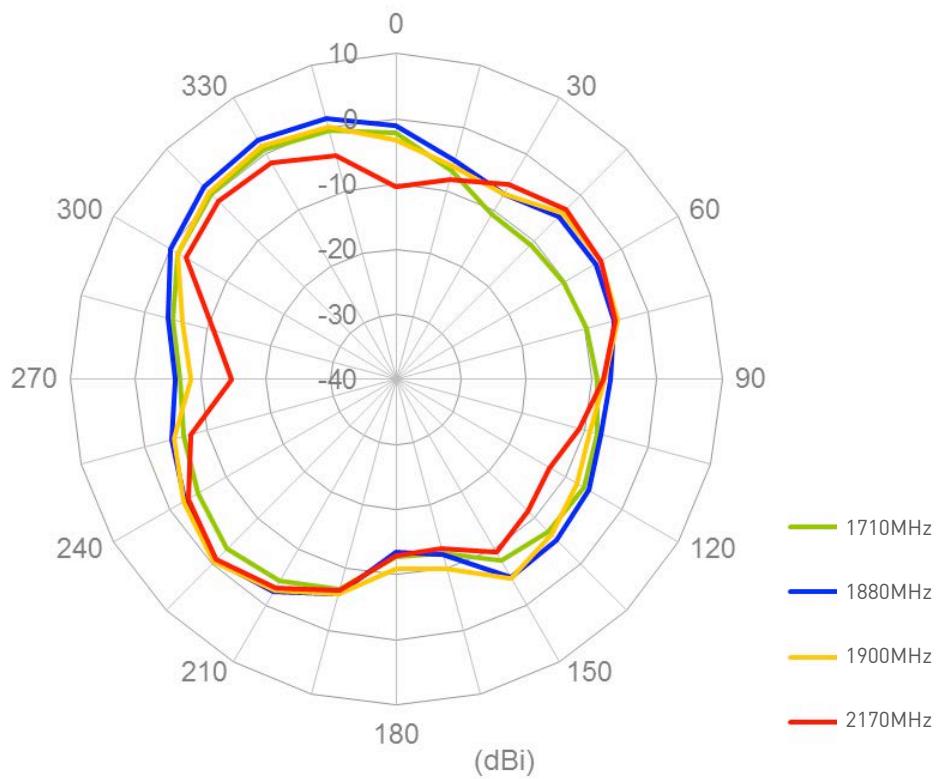
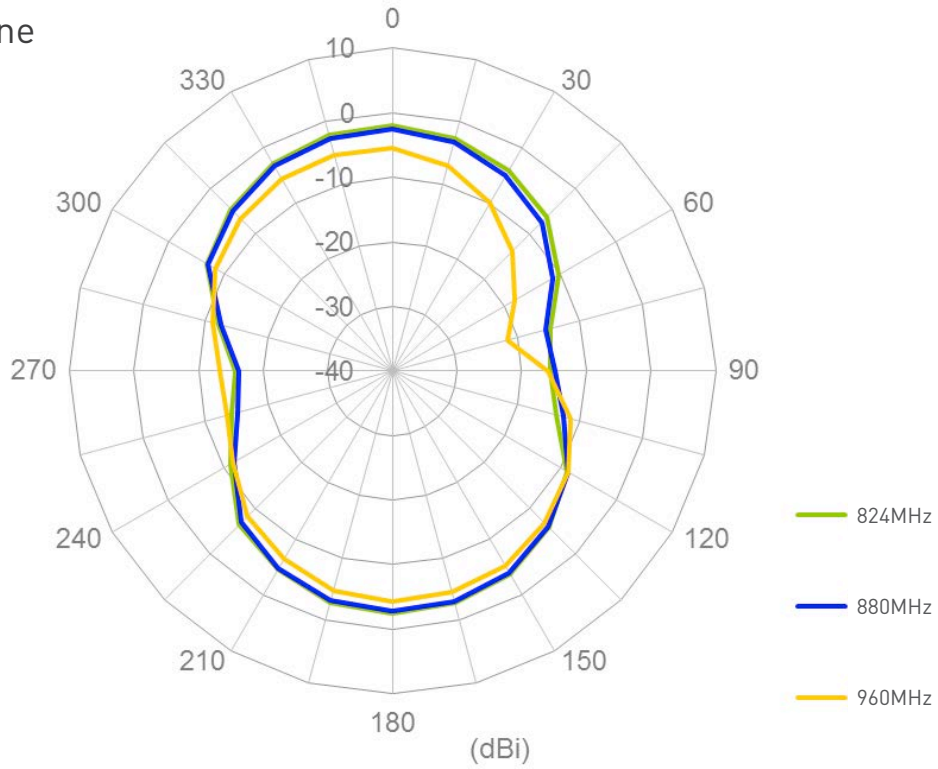

XZ Plane

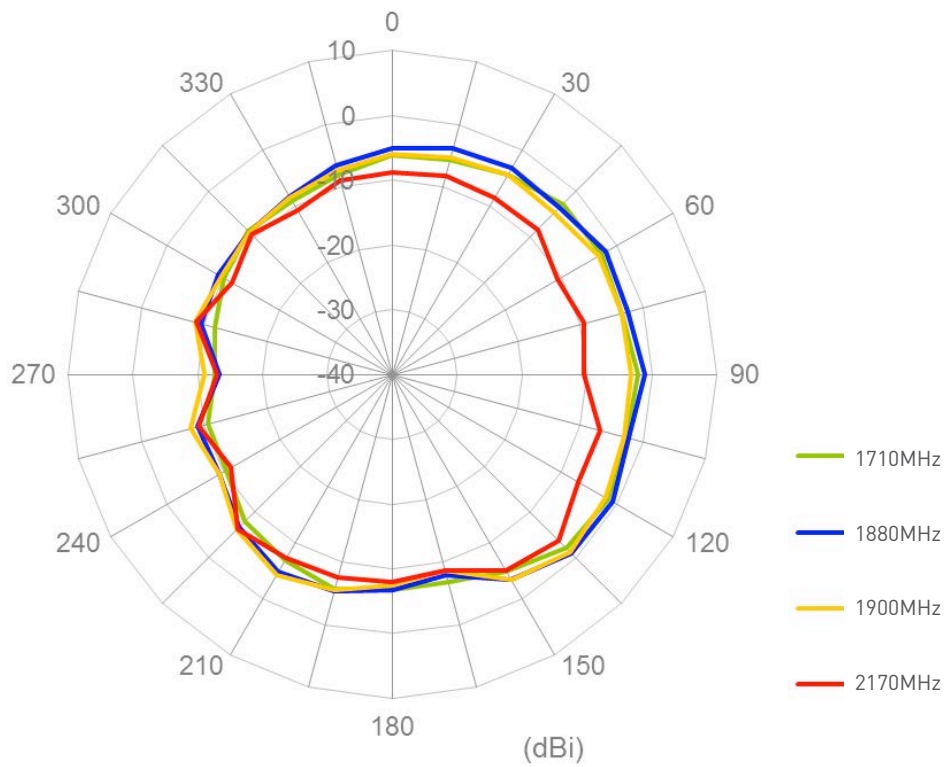
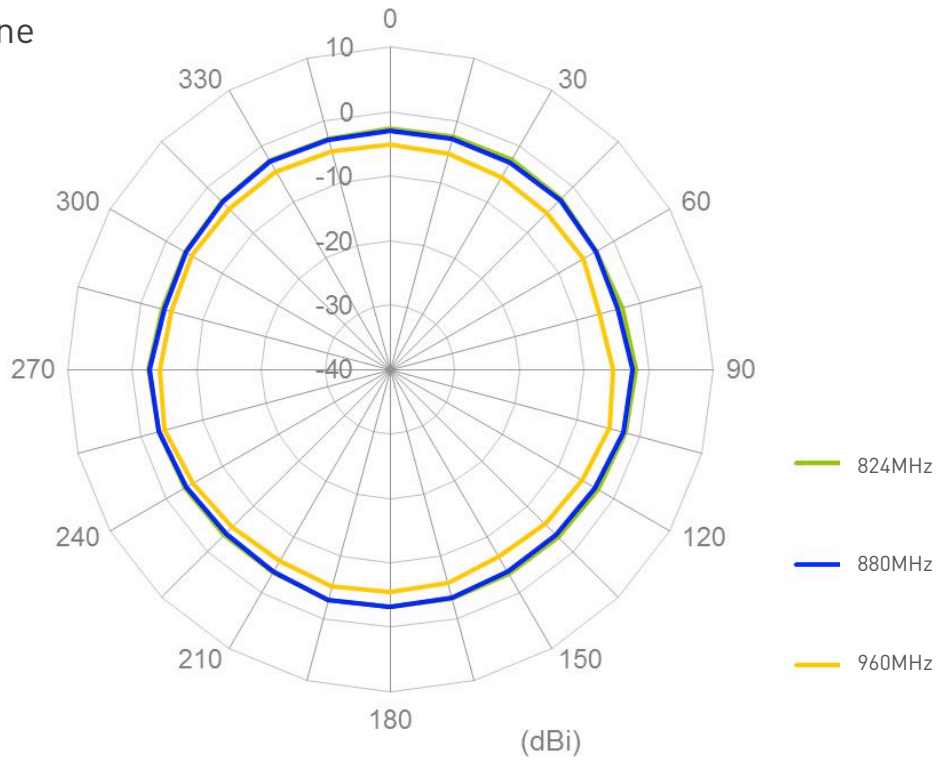

5. Matching Circuits

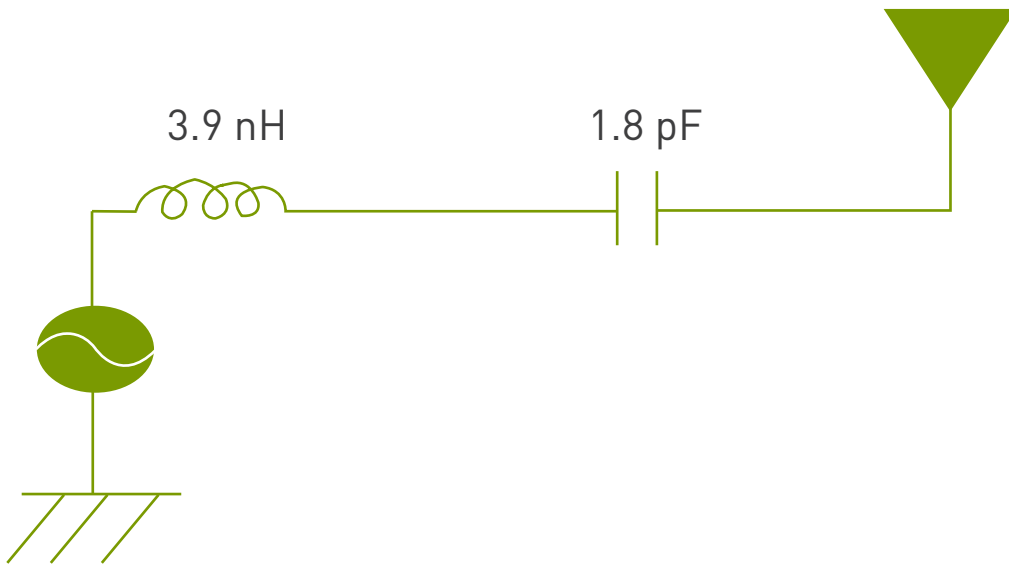

6. Drawing

6.1 PCS.07.A Antenna

Top View



YYWW - date code, production year and week

Bottom View

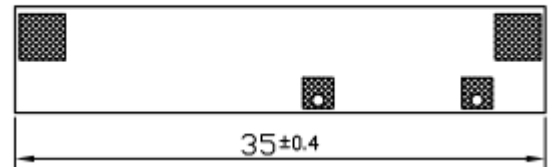

Side View

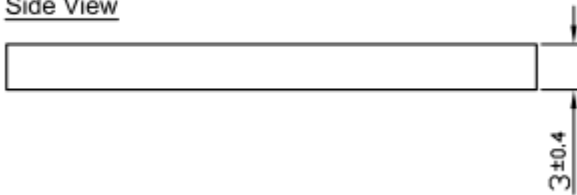

6.2 PCS.07.A Footprint



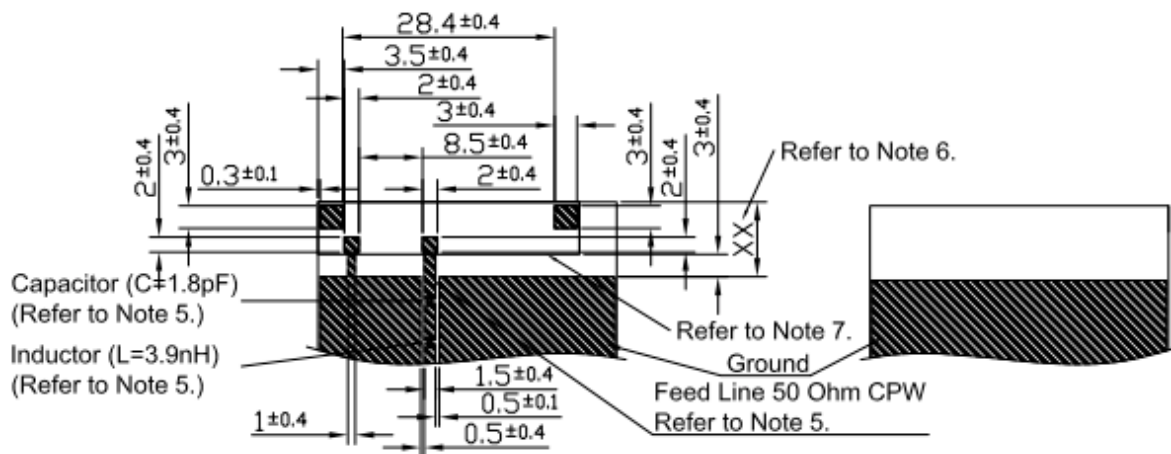

Footprint
0.8t PCB

Top View

Bottom View



Notes

- | | | |
|-----------------------|---|---|
| 1. Tin Plated |  | 5. Matching circuit - value changes according to ground and layout. |
| 2. Silkscreen (Black) |  | 6. Antenna outline for placement reference. |
| 3. Soldermask (Gold) |  | 7. Keep out area. |
| 4. Copper |  | |

6.3 PCS.07.A Evaluation Board

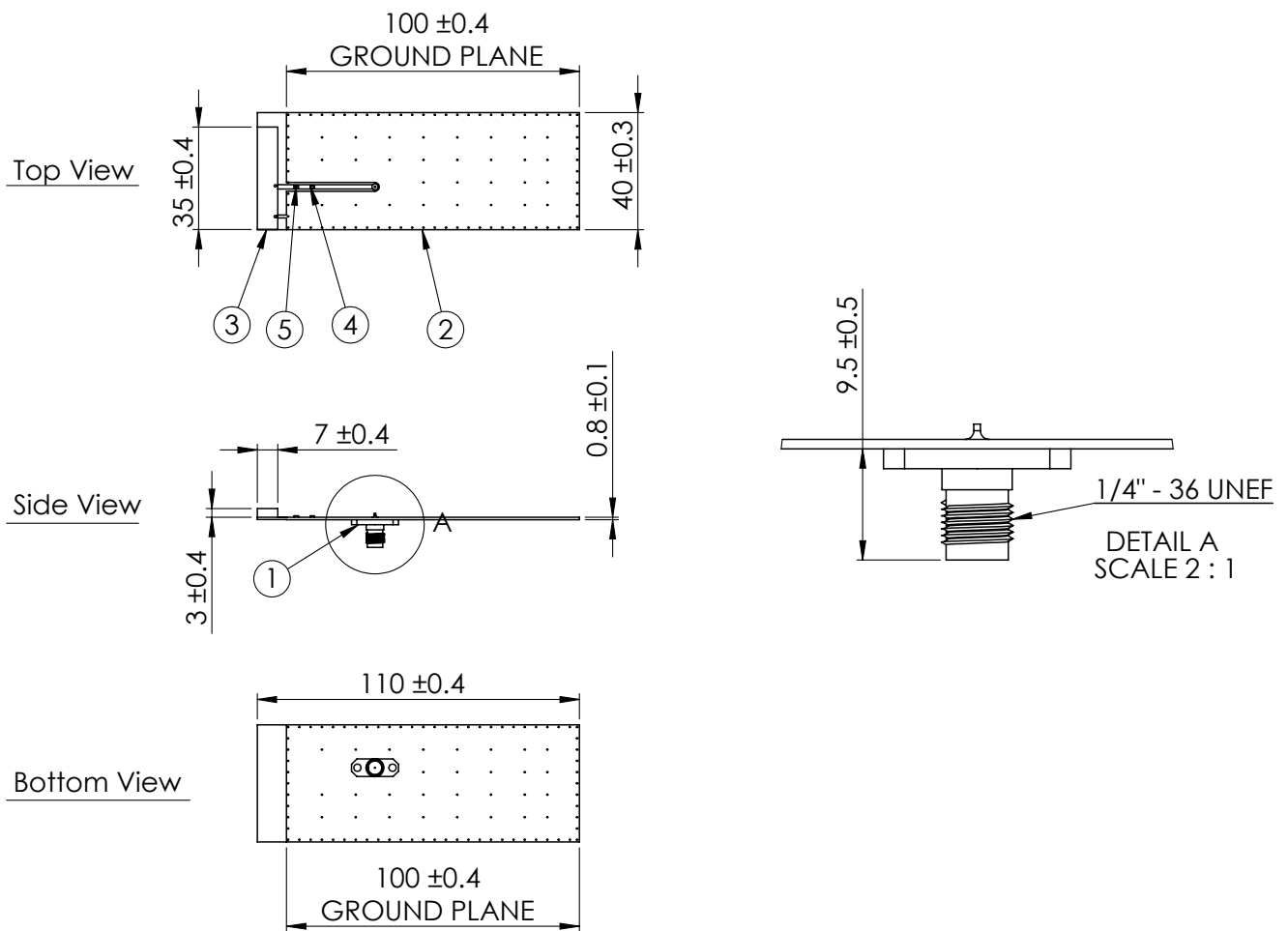

	Name	Material	Finish	QTY
1	PCB SMA(F) ST	Brass	Gold	1
2	PCSD.07.A PCB	FR4 0.8t	Gold	1
3	PCS.07.A	FR4 3.0t	Gold	1
4	Inductor (L=3.9nH)	Ceramic	N/A	1
5	Capacitor (C=1.8pF)	Ceramic	N/A	1

7. Application Note

Investigations of PCS.07.A antenna performance on different lengths of ground plane were conducted, the return loss is shown as below.

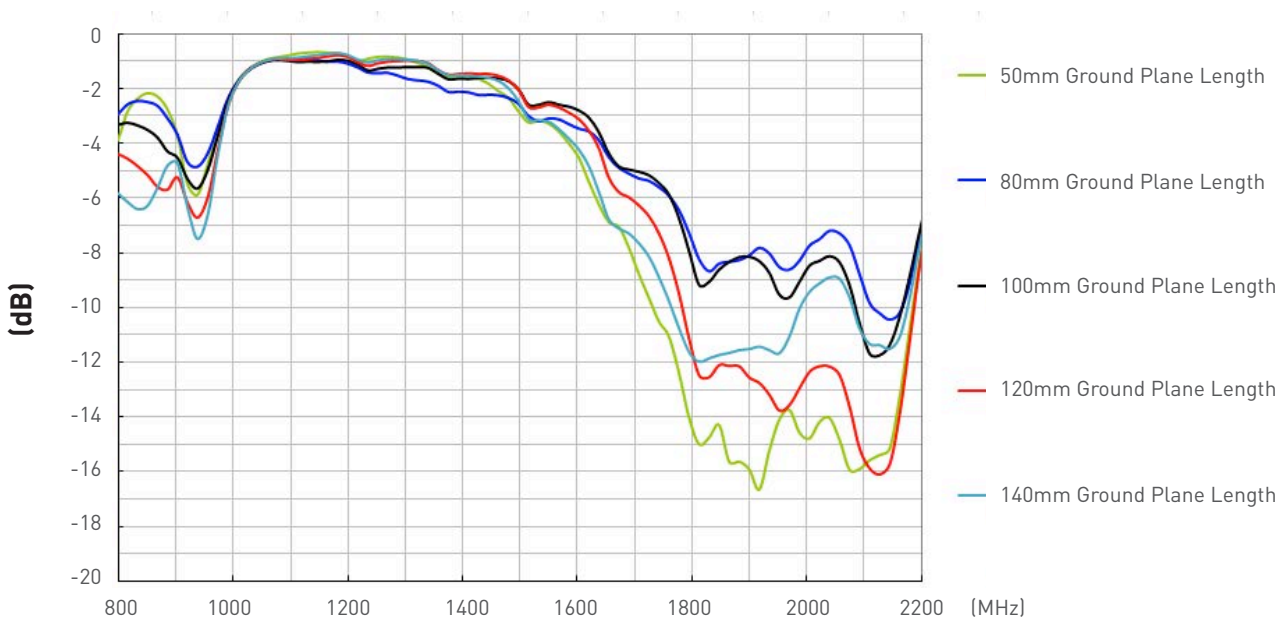

The antenna performance are shown on below,

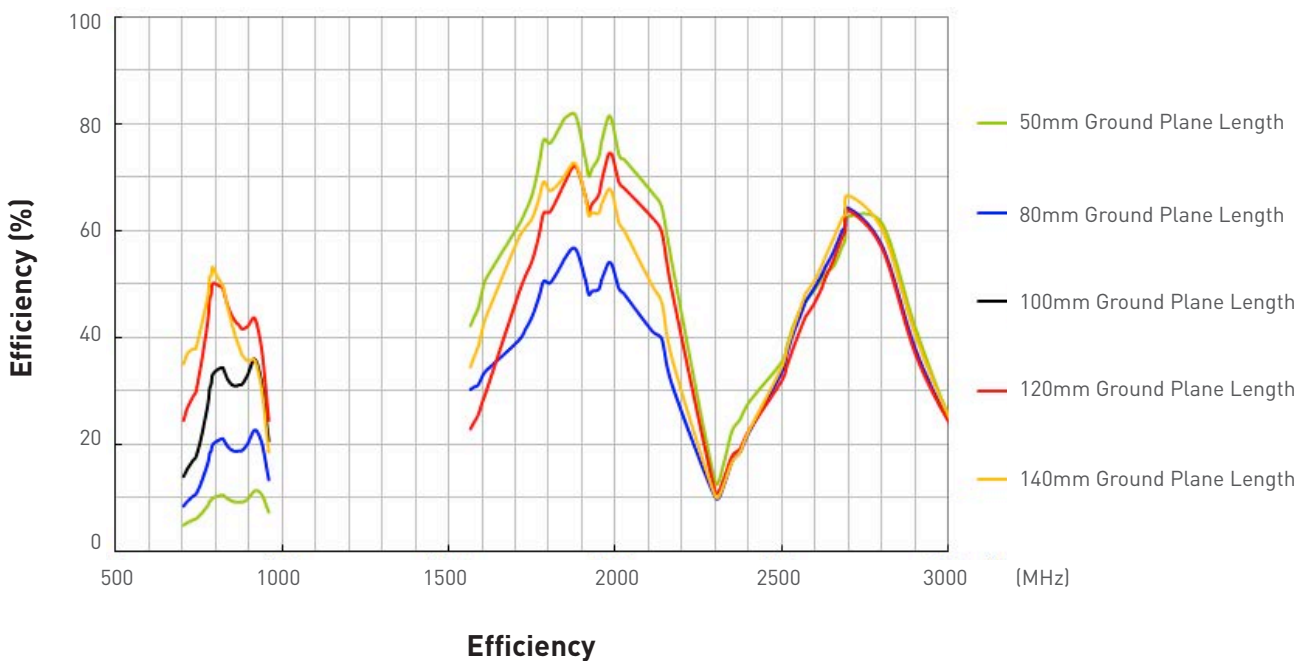

7. Application Note

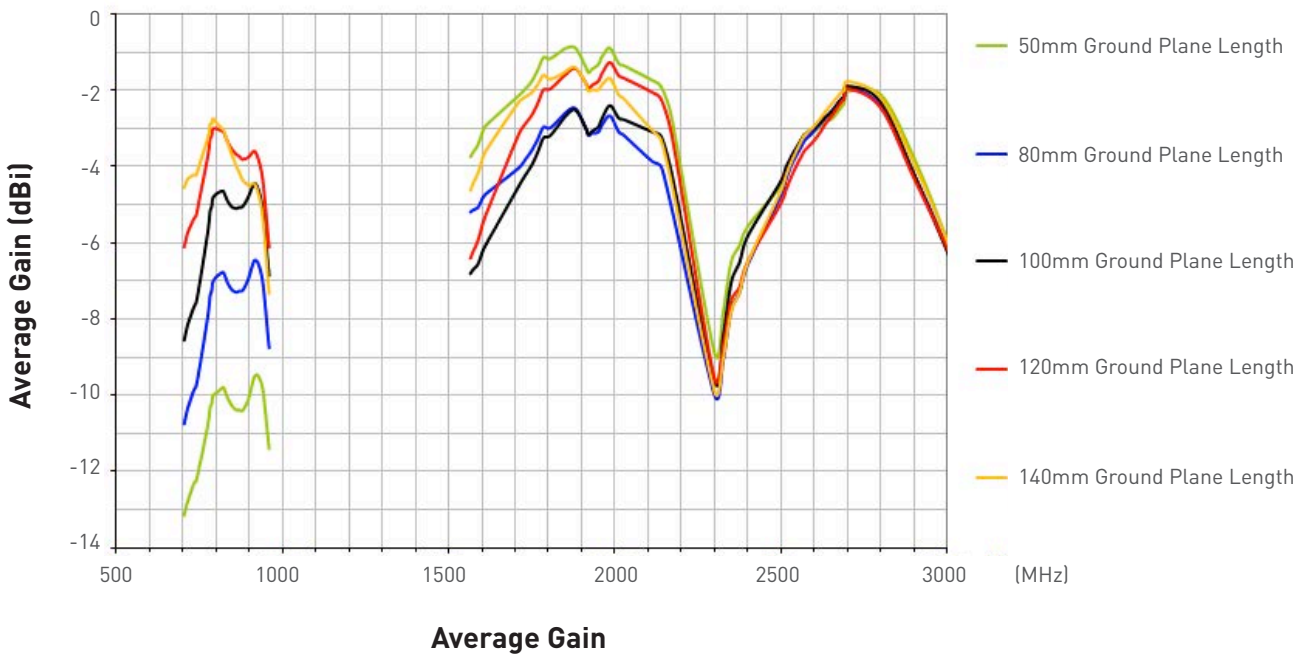
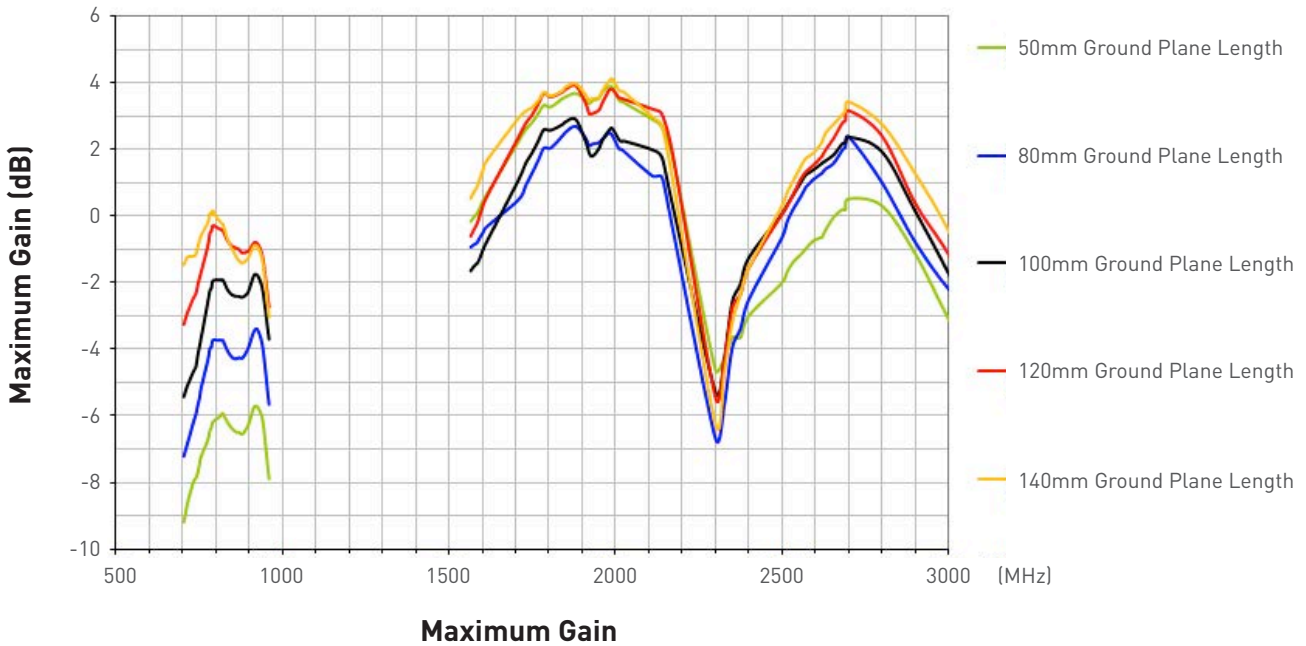

Taoglas makes no warranties based on the accuracy or completeness of the contents of this document and reserves the right to make changes to specifications and

product descriptions at any time without notice. Taoglas reserves all rights to this document and the information contained herein.

Reproduction, use or disclosure to third parties without express permission is strictly prohibited.
Copyright © Taoglas Ltd.