

# NAIS

## COST SAVING SUBMINIATURE PC BOARD RELAYS

# HA-RELAYS

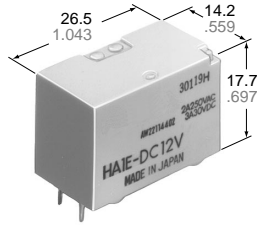
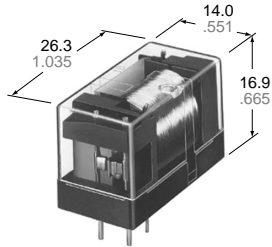

HAE Amber Relays

mm inch

## FEATURES

- Compact construction
- Sensitive - very low operating power
- Soldering flux inflow prevented by molded construction
- Contact capacity - 3 A 250 V AC, 30 V DC
- Simple mechanism for stable quality - only 9 pieceparts
- Amber sealed types available

## SPECIFICATIONS

### HA1 Standard type

#### Contacts

Arrangement	1 Form C		
Contact material	Silver-nickel		
Initial contact resistance, max. (By voltage drop 6 V DC 1 A)	50 mΩ		
Rating (resistive load)	Max. switching power	750 VA, 90 W	
	Max. switching voltage	250 V AC, 30 V DC	
	Max. switching current	3 A	
Expected life (min. operations)	Mechanical	10 <sup>7</sup>	
	Electrical (resistive)	3 A 250 V AC	10 <sup>5</sup>
		3 A 30 V DC	5×10 <sup>5</sup>

#### Coil

Minimum operating power	(AC) 0.58 VA, (DC) 230 mW
Nominal operating power	(AC) 0.9 VA, (DC) 360 mW

#### Characteristics

Maximum operating speed	20 cpm	
Initial insulation resistance* <sup>1</sup> (at 25°C, 50% R.H.)	Min. 100 MΩ at 500 V DC	
Initial breakdown voltage* <sup>2</sup>	Between open contacts	750 Vrms for 1 min.
	Between contacts and coil	1,500 Vrms for 1 min.
Operate time* <sup>3</sup> (at nominal voltage) (at 20°C)	Approx. 6 ms (AC), Approx. 5 ms (DC)	
Release time (without diode)* <sup>3</sup> (at nominal voltage)(at 20°C)	Approx. 6 ms (AC), Approx. 3 ms (DC)	
Temperature rise (at 20°C)	Max. (AC) 60°C, (DC) 40°C with nominal coil voltage and at 3A switching current	
Shock resistance	Functional	98 m/s <sup>2</sup> {10G}
	Destructive	980 m/s <sup>2</sup> {100G}
Vibration resistance	Functional	10 to 55Hz at double amplitude of 1mm
	Destructive	10 to 55Hz at switching of 2mm
Conditions for operation, transport and storage* <sup>4</sup> (Not freezing and con- densing at low tempera- ture)	Ambient temp.	-40°C to +50°C -40°F to +122°F
	Humidity	5 to 85%R.H.
Unit weight	Approx. 15 g .53 oz	

#### Remarks

- \* Specifications will vary with foreign standards certification ratings.  
<sup>1</sup> Measurement at same location as "Initial breakdown voltage" section  
<sup>2</sup> Detection current: 10 mA

### HA1E Amber sealed type

#### Contacts

Arrangement	1 Form C		
Contact material	Gold-clad over silver-nickel		
Initial contact resistance, max. (By voltage drop 6 V DC 1 A)	50 mΩ		
Rating (resistive load)	Max. switching power	500 VA, 90 W	
	Max. switching voltage	250 V AC, 30 V DC	
	Max. switching current	2 A AC, 3A DC	
Expected life (min. operations)	Mechanical	10 <sup>7</sup>	
	Electrical (resistive)	2 A 250 V AC	10 <sup>5</sup>
		3 A 30 V DC	2×10 <sup>5</sup>

#### Coil

Minimum operating power	(AC) 0.58 VA, (DC) 230 mW
Nominal operating power	(AC) 0.9 VA, (DC) 360 mW

#### Characteristics

Maximum operating speed	20 cpm	
Initial insulation resistance* <sup>1</sup> (at 25°C, 50% R.H.)	Min. 100 MΩ at 500 V DC	
Initial breakdown voltage* <sup>2</sup>	Between open contacts	750 Vrms for 1 min.
	Between contacts and coil	1,500 Vrms for 1 min.
Operate time* <sup>3</sup> (at nominal voltage) (at 20°C)	Approx. 6 ms (AC), Approx. 5 ms (DC)	
Release time (without diode)* <sup>3</sup> (at nominal voltage)(at 20°C)	Approx. 6 ms (AC), Approx. 3 ms (DC)	
Temperature rise (at 50°C)	Max. (AC) 60°C, (DC) 40°C with nominal coil voltage and at 3A switching current	
Shock resistance	Functional	98 m/s <sup>2</sup> {10G}
	Destructive	980 m/s <sup>2</sup> {100G}
Vibration resistance	Functional	10 to 55Hz at double amplitude of 1mm
	Destructive	10 to 55Hz at double amplitude of 2mm
Conditions for operation, transport and storage* <sup>4</sup> (Not freezing and con- densing at low tempera- ture)	Ambient temp.	-40°C to +50°C -40°F to +122°F
	Humidity	5 to 85%R.H.
Unit weight	Approx. 15 g .53 oz	

- \*<sup>3</sup> Excluding contact bounce time  
<sup>4</sup> Refer to 5. Conditions for operation, transport and storage mentioned in  
 AMBIENT ENVIRONMENT (Page 61).

# TYPICAL APPLICATIONS

Office machines, electrical home appliances, load management equipment.

# ORDERING INFORMATION

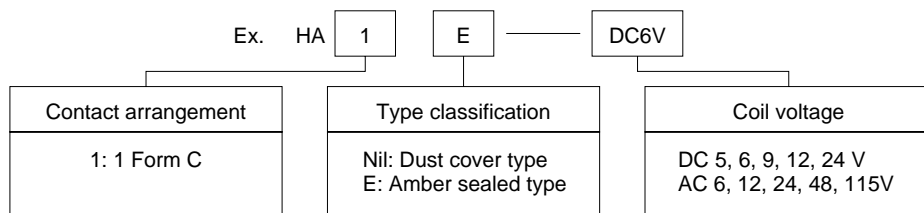

Notes: 1. For UL/CSA recognized types, add suffix UL/CSA.  
2. Standard packing Carton: 100 pcs., Case: 500 pcs. or 2,000 pcs.

# TYPES AND COIL DATA (at 20°C 68°F)

Part No.	Nominal voltage	Pick-up voltage, (max.)	Drop-out voltage, (min.)	* Nominal operating current, mA	Nominal operating power	Coil resistance, Ω (±10%)	Maximum allowable voltage
HA1-AC6V HA1E-AC6V	6 V AC	4.8 V AC	1.2 V AC	150	0.9 VA	—	6.6 V AC
HA1-AC12V HA1E-AC12V	12 V AC	9.6 V AC	2.4 V AC	76	0.9 VA	—	13.2 V AC
HA1-AC24V HA1E-AC24V	24 V AC	19.2 V AC	4.8 V AC	37	0.9 VA	—	26.4 V AC
HA1-AC48V HA1E-AC48V	48 V AC	38.4 V AC	9.6 V AC	19	0.9 VA	—	52.8 V AC
HA1-AC115V HA1E-AC115V	115 V AC	92.0 V AC	23.0 V AC	8	0.9 VA	—	126.5 V AC
HA1-DC5V HA1E-DC5V	5 V DC	4.0 V DC	0.5 V DC	72	360 mW	69	6.0 V DC
HA1-DC6V HA1E-DC6V	6 V DC	4.8 V DC	0.6 V DC	60	360 mW	100	7.2 V DC
HA1-DC9V HA1E-DC9V	9 V DC	7.2 V DC	0.9 V DC	40	360 mW	225	10.8 V DC
HA1-DC12V HA1E-DC12V	12 V DC	9.6 V DC	1.2 V DC	30	360 mW	400	14.4 V DC
HA1-DC24V HA1E-DC24V	24 V DC	19.2 V DC	2.4 V DC	15	360 mW	1,600	28.8 V DC

Note: The range of coil current — AC type: ±15% at 60 Hz, DC type: ±10% at 20°C 68°F coil temperature.

# DIMENSIONS

mm inch

HA1

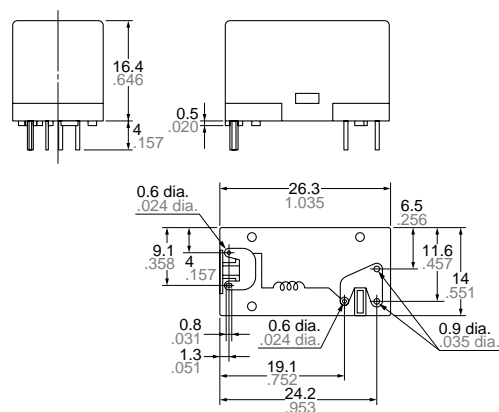

General tolerance: ±0.5 ±.020

HA1E

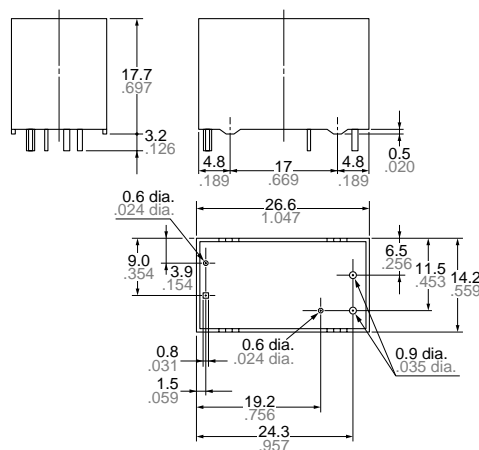

General tolerance: ±0.5 ±.004

PC board pattern (Copper-side view)

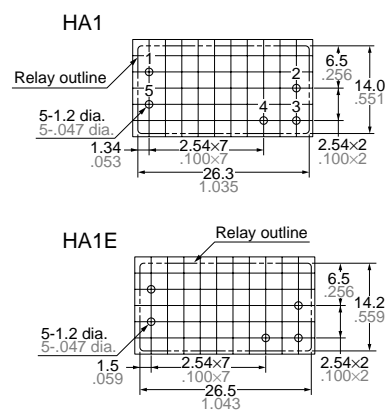

Schematic (Bottom view)

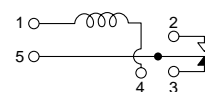

## REFERENCE DATA

1.-(1) Coil temperature rise (AC PC board type)  
Point measured: Inside the coil

1.-(2) Coil temperature rise (DC PC board type)

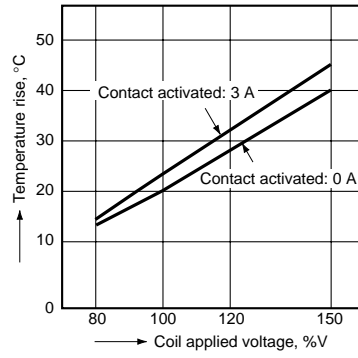
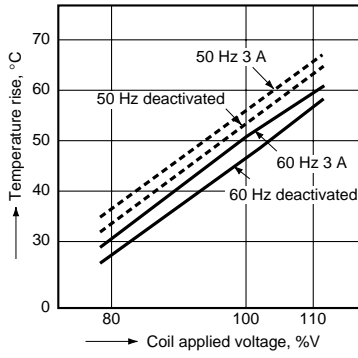

### Operate and release time

Sample: HA1-DC12V

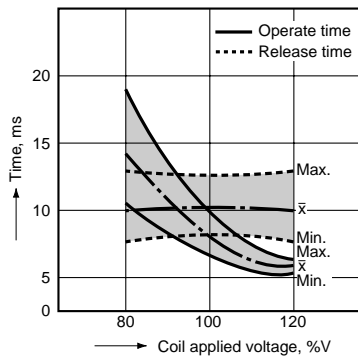

Sample: HA1-AC115V

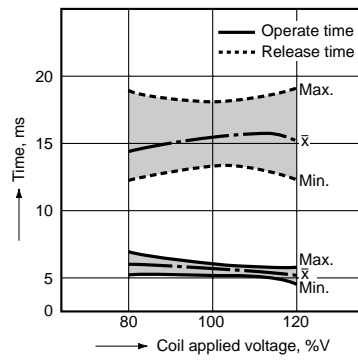

**For Cautions for Use, see Relay Technical Information (Page 48 to 76).**