



2SD965/A

NPN SILICON TRANSISTOR

LOW VOLTAGE HIGH CURRENT TRANSISTOR

■ **FEATURES**

- * Collector current up to 5A
- * UTC **2SD965**: Collector-Emitter voltage up to 20 V
- * UTC **2SD965A**: Collector-Emitter voltage up to 30 V

■ **APPLICATIONS**

- * Audio amplifier
- * Flash unit of camera
- * Switching circuit

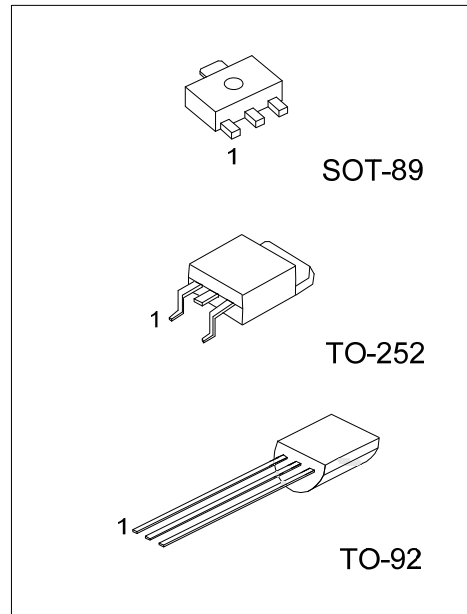

Lead-free: 2SD965L/2SD965AL
 Halogen-free: 2SD965G/2SD965AG

■ **ORDERING INFORMATION**

Ordering Number			Package	Pin Assignment			Packing
Normal	Lead Free	Halogen Free		1	2	3	
2SD965-x-AB3-R	2SD965L-x-AB3-R	2SD965G-x-AB3-R	SOT-89	B	C	E	Tape Reel
2SD965-x-T92-B	2SD965L-x-T92-B	2SD965G-x-T92-B	TO-92	E	C	B	Tape Box
2SD965-x-T92-K	2SD965L-x-T92-K	2SD965G-x-T92-K	TO-92	E	C	B	Bulk
2SD965-x-TN3-R	2SD965L-x-TN3-R	2SD965G-x-TN3-R	TO-252	B	C	E	Tape Reel
2SD965A-x-AB3-R	2SD965AL-x-AB3-R	2SD965AG-x-AB3-R	SOT-89	B	C	E	Tape Reel
2SD965A-x-T92-B	2SD965AL-x-T92-B	2SD965AG-x-T92-B	TO-92	E	C	B	Tape Box
2SD965A-x-T92-K	2SD965AL-x-T92-K	2SD965AG-x-T92-K	TO-92	E	C	B	Bulk
2SD965A-x-TN3-R	2SD965AL-x-TN3-R	2SD965AG-x-TN3-R	TO-252	B	C	E	Tape Reel

<p>2SD965L-x-AB3-R</p>	<p>(1) B: Tape Box, K: Bulk, R: Tape Reel, T: Tube (2) AB3: SOT-89, T92: TO-92, TN3: TO-252 (3) x: refer to Classification of h_{FE2} (4) G: Halogen Free, L: Lead Free, Blank: Pb/Sn</p>
------------------------	---

■ ABSOLUTE MAXIMUM RATING (Ta=25°C)

PARAMETER	SYMBOL	RATINGS	UNIT
Collector-Base Voltage	V _{CBO}	40	V
Collector-Emitter Voltage	V _{CEO}	2SD965	20
		2SD965A	30
Emitter-Base Voltage	V _{EBO}	7	V
Collector Dissipation	P _C	SOT-89	500
		TO-92	750
		TO-252	1
Collector Current	I _C	5	A
Junction Temperature	T _J	150	°C
Storage Temperature	T _{STG}	-65 ~ +150	°C

Note: Absolute maximum ratings are those values beyond which the device could be permanently damaged. Absolute maximum ratings are stress ratings only and functional device operation is not implied.

■ ELECTRICAL CHARACTERISTICS (Ta=25°C, unless otherwise specified)

PARAMETER	SYMBOL	TEST CONDITIONS	MIN	TYP	MAX	UNIT
Collector-Base Breakdown Voltage	BV _{CBO}	I _C =100μA, I _E =0	40			V
Collector-Emitter Breakdown Voltage	BV _{CEO}	I _C =1mA, I _B =0	2SD965	20		V
			2SD965A	30		V
Emitter-Base Breakdown Voltage	BV _{EBO}	I _E =10μA, I _C =0	7			V
Collector Cut-off Current	I _{CBO}	V _{CB} =10V, I _E =0			100	nA
Emitter Cut-off Current	I _{EBO}	V _{EB} =7V, I _C =0			100	nA
DC Current Gain(note)	h _{FE}	V _{CE} =2V, I _C =1mA		200		
		V _{CE} =2V, I _C =0.5A	230		800	
		V _{CE} =2V, I _C =2A	150			
Collector-Emitter Saturation Voltage	V _{CE(SAT)}	I _C =3A, I _B =0.1A			1	V
Current Gain Bandwidth Product	f _T	V _{CE} =6V, I _C =50mA		150		MHz
Output Capacitance	C _{ob}	V _{CB} =20V, I _E =0, f=1MHz			50	pF

■ CLASSIFICATION OF h_{FE2}

RANK	Q	R	S
RANGE	230-380	340-600	560-800

TYPICAL CHARACTERISTICS

Static Characteristics

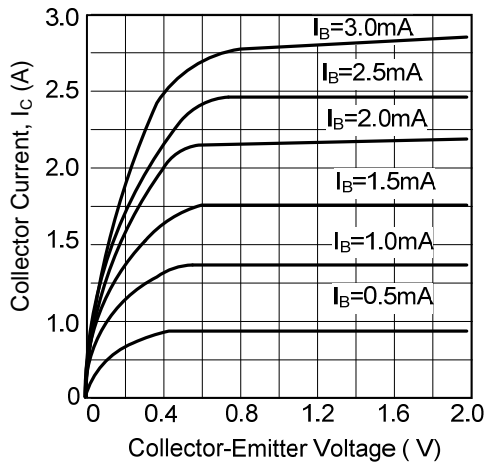

DC Current Gain

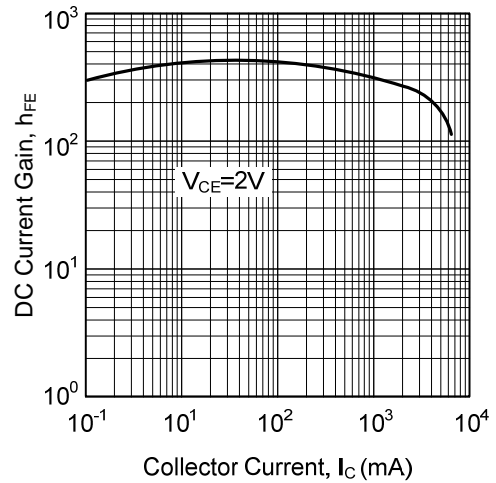

Base-Emitter on Voltage

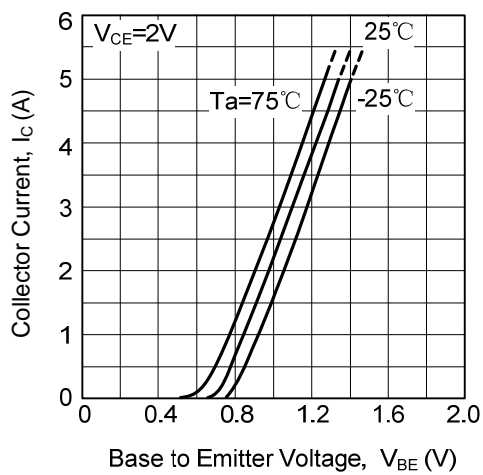

Saturation Voltage

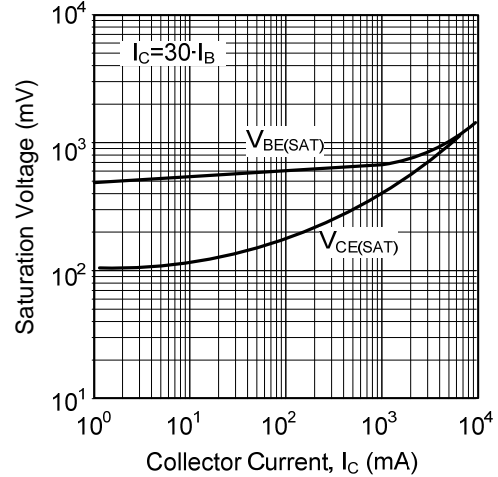

Current Gain-Bandwidth Product

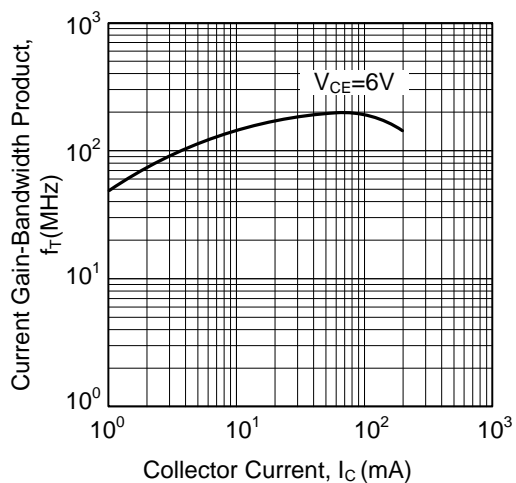

Collector Output Capacitance

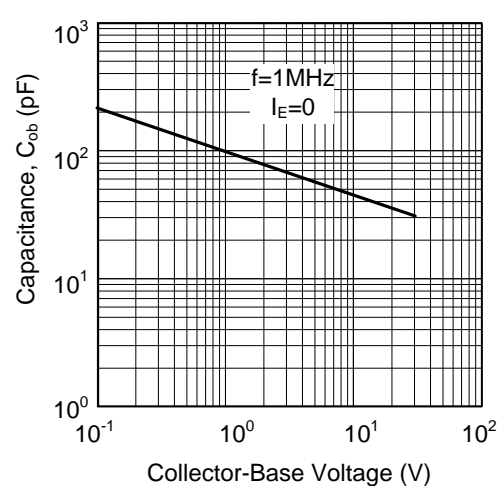

■ TYPICAL CHARACTERISTICS

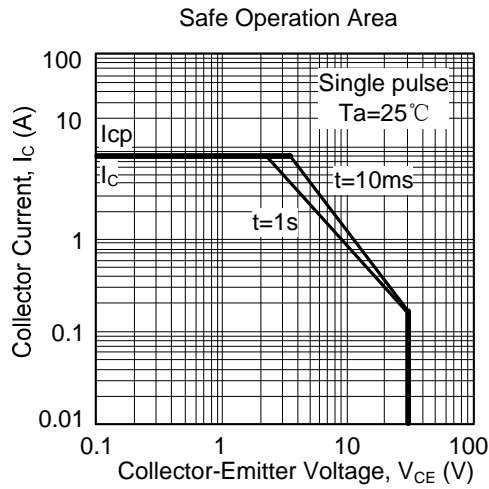

UTC assumes no responsibility for equipment failures that result from using products at values that exceed, even momentarily, rated values (such as maximum ratings, operating condition ranges, or other parameters) listed in products specifications of any and all UTC products described or contained herein. UTC products are not designed for use in life support appliances, devices or systems where malfunction of these products can be reasonably expected to result in personal injury. Reproduction in whole or in part is prohibited without the prior written consent of the copyright owner. The information presented in this document does not form part of any quotation or contract, is believed to be accurate and reliable and may be changed without notice.