

## Surface Mount General Purpose Silicon Rectifiers

Reverse Voltage - 50 to 1000 V Forward Current - 1 A

### FEATURES

- For surface mounted applications
- Low profile package
- Glass Passivated Chip Junction
- Easy to pick and place
- Lead free in comply with EU RoHS 2011/65/EU directives

### MECHANICAL DATA

- Case: SMAF
- Terminals: Solderable per MIL-STD-750, Method 2026
- Approx. Weight: 27mg / 0.00095oz

### PINNING

PIN	DESCRIPTION
1	Cathode
2	Anode

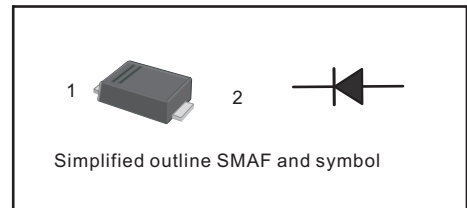

### Maximum Ratings and Electrical characteristics

Ratings at 25 °C ambient temperature unless otherwise specified.

Single phase half-wave 60 Hz, resistive or inductive load, for capacitive load current derate by 20 %.

Parameter	Symbols	1N4001F	1N4002F	1N4003F	1N4004F	1N4005F	1N4006F	1N4007F	Units
Maximum Repetitive Peak Reverse Voltage	$V_{RRM}$	50	100	200	400	600	800	1000	V
Maximum RMS voltage	$V_{RMS}$	35	70	140	280	420	560	700	V
Maximum DC Blocking Voltage	$V_{DC}$	50	100	200	400	600	800	1000	V
Maximum Average Forward Rectified Current at $T_a = 65\text{ °C}$	$I_{F(AV)}$	1							A
Peak Forward Surge Current 8.3 ms Single Half Sine Wave Superimposed on Rated Load (JEDEC Method)	$I_{FSM}$	30							A
Maximum Instantaneous Forward Voltage at 1 A	$V_F$	1.1							V
Maximum DC Reverse Current at Rated DC Blocking Voltage $T_a = 25\text{ °C}$ $T_a = 125\text{ °C}$	$I_R$	5 50							$\mu\text{A}$
Typical Junction Capacitance <sup>1)</sup>	$C_j$	9							pF
Typical Thermal Resistance <sup>2)</sup>	$R_{\theta JA}$	115							°C/W
Operating and Storage Temperature Range	$T_j, T_{stg}$	-55 ~ +150							°C

1) Measured at 1 MHz and applied reverse voltage of 4 V D.C

2) P.C.B. mounted with 0.2 X 0.2" (5 X 5 mm) copper pad areas.

**Fig.1 Forward Current Derating Curve**

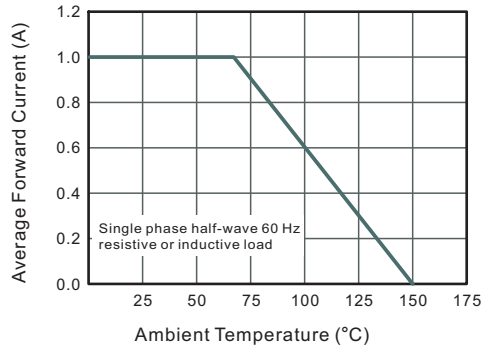

**Fig.2 Typical Instantaneous Reverse Characteristics**

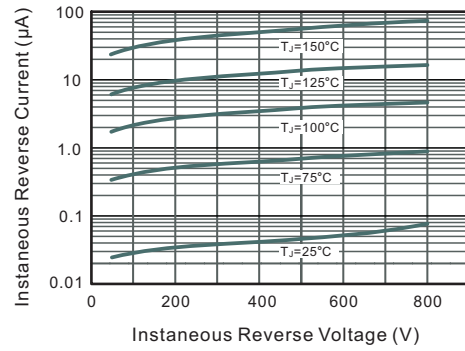

**Fig.3 Typical Forward Characteristic**

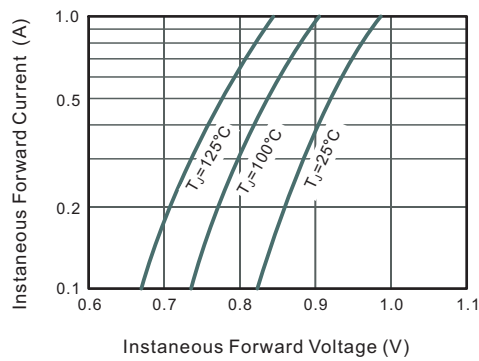

**Fig.4 Typical Junction Capacitance**

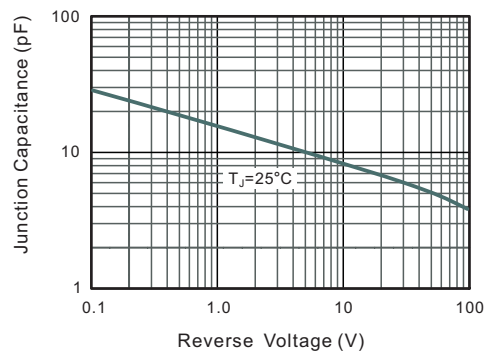

**Fig.5 Maximum Non-Repetitive Peak Forward Surge Current**

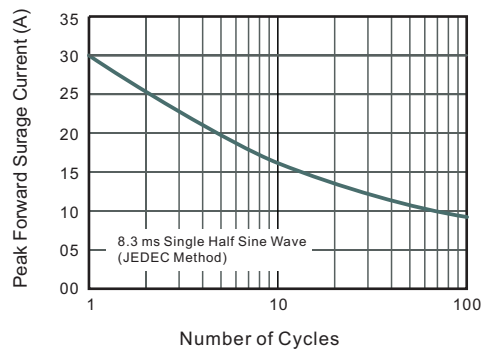

## PACKAGE OUTLINE

Plastic surface mounted package; 2 leads

SMAF

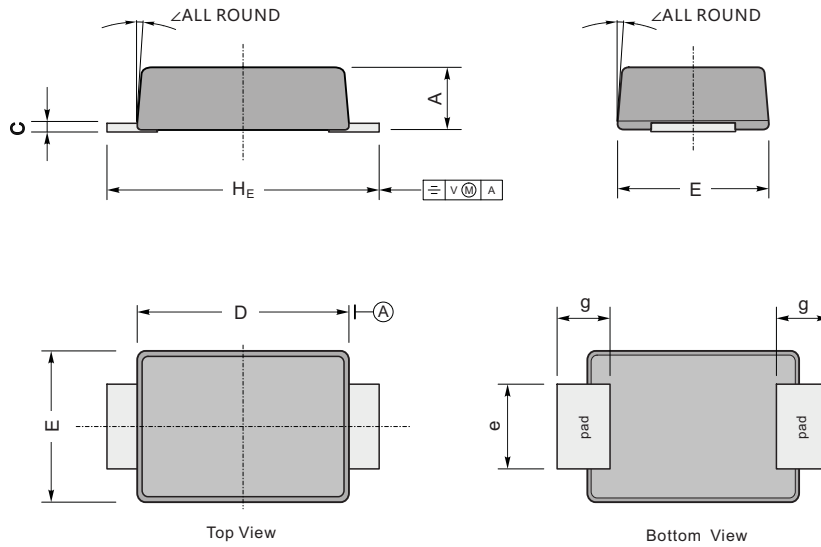

UNIT		A	C	D	E	e	g	H <sub>E</sub>	$\angle$
mm	max	1.1	0.20	3.7	2.7	1.6	1.2	4.9	7°
	min	0.9	0.12	3.3	2.4	1.3	0.8	4.4	
mil	max	43	7.9	146	106	63	47	193	
	min	35	4.7	130	94	51	31	173	

### The recommended mounting pad size

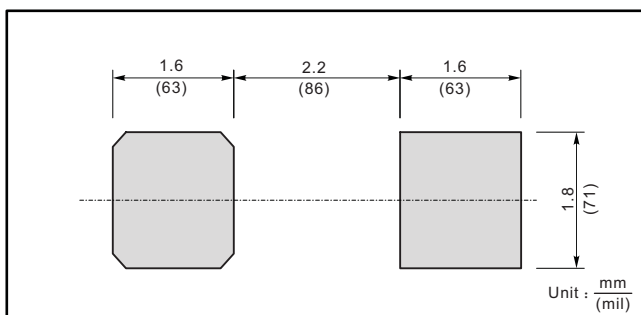

### Marking

Type number	Marking code
1N4001F	M1
1N4002F	M2
1N4003F	M3
1N4004F	M4
1N4005F	M5
1N4006F	M6
1N4007F	M7