



# NEC's 1310 nm InGaAsP MQW FP LASER DIODE IN COAXIAL PACKAGE FOR 155 Mb/s APPLICATION

**NX7303BA-CC**  
**NX7303CA-CC**

## FEATURES

- **CENTER WAVELENGTH:**  
 $\lambda_c = 1310 \text{ nm}$
- **OPTICAL OUTPUT POWER:**  
 $P_f = 1.0 \text{ mW}$
- **LOW THRESHOLD CURRENT:**  
 $I_{TH} = 9 \text{ mA}$
- **HIGH CUTOFF FREQUENCY:**  
 $f_c = 2.0 \text{ GHz}$
- **InGaAs MONITOR PIN-PD**
- **WITH SC-UPC CONNECTOR**
- **WIDE OPERATING TEMPERATURE RANGE:**  
-40 to +85°C
- **BASED ON TELCORDIA RELIABILITY**

## DESCRIPTION

NEC's NX7303BA-CC and NX7303CA-CC are 1310 nm Fabry-Perot (FP) laser diode coaxial modules with single mode fiber. They have a Multiple Quantum Well (MQW) structure and a built-in InGaAs monitor photo diode. These modules are ideal as a light source for Synchronous Digital Hierarchy (SDH) systems, STM-1 and long-haul L-1.1 ITU-T recommendations.

## ELECTRO-OPTICAL CHARACTERISTICS (Tc = -40 to +85°C, unless otherwise specified)

PART NUMBER			NX7303BA-CC, NX7303CA-CC		
SYMBOLS	PARAMETERS AND CONDITIONS	UNITS	MIN	TYP	MAX
P <sub>f</sub>	Optical Output Power from Fiber	mW		1.0	
V <sub>OP</sub>	Operating Voltage, P <sub>f</sub> = 1.0 mW	V		1.2	1.5
I <sub>TH</sub>	Threshold Current	T <sub>c</sub> = +25°C	4	9	20
			2		50
P <sub>TH</sub>	Threshold Output Power, I <sub>F</sub> = I <sub>TH</sub>	μW			75
I <sub>MOD</sub>	Modulation Current	P <sub>f</sub> = 1.0 mW, T <sub>c</sub> = 25°C	8	15	35
		P <sub>f</sub> = 1.0 mW	5		60
η <sub>d</sub>	Differential Efficiency	P <sub>f</sub> = 1.0 mW, T <sub>c</sub> = 25°C	0.030	0.070	0.100
		P <sub>f</sub> = 1.0 mW	0.018		0.150
Δη <sub>d</sub>	Temperature Dependence of Differential Efficiency, $\Delta\eta_d = 10 \log \frac{\eta_d (@ T_c \text{ } ^\circ\text{C})}{\eta_d (@ 25 \text{ } ^\circ\text{C})}$	dB	-3	-2	
Kink	Kink, P <sub>f</sub> = Up to 1.2 mW (Refer to Definitions)	%			±20
λ <sub>c</sub>	Center Wavelength, P <sub>f</sub> = 1.0 mW, RMS (-20 dB)	nm	1263	1310	1360
Δλ/ΔT	Temperature Dependence of Center Wavelength	nm/°C		0.4	0.5
σ	Spectral Width, P <sub>f</sub> = 1.0 mW, RMS (-20 dB)	nm		1.3	4.0
f <sub>c</sub>	Cut-off Frequency, -3 dB	GHz		2.0	
t <sub>r</sub>	Rise Time, 10 to 90%, P <sub>pk</sub> = 1.0 mW, I <sub>F</sub> = I <sub>TH</sub>	ns		0.2	0.5
t <sub>f</sub>	Fall Time, 90 to 10%, P <sub>pk</sub> = 1.0 mW, I <sub>F</sub> = I <sub>TH</sub>	ns		0.3	0.5
Applicable to Monitor PD: T <sub>c</sub> = -40 to +85 °C unless otherwise specified					
I <sub>m</sub>	Monitor Current, V <sub>R</sub> = 5 V, P <sub>f</sub> = 1.0 mW	μA	100	700	1200
I <sub>D</sub>	Dark Current	V <sub>R</sub> = 5 V, T <sub>c</sub> = 25 °C	nA	0.1	50
		V <sub>R</sub> = 5 V	nA	10	500
C <sub>t</sub>	Terminal Capacitance, V <sub>R</sub> = 5 V, f = 1 MHz	pF			20
LIN <sub>m</sub>	Linearity, V <sub>R</sub> = 5 V, P <sub>f</sub> = 0.1 to 1.0 mW (Refer to Definitions)	%			±10
γ	Tracking Error, I <sub>m</sub> = const. (Refer to Definitions)	dB		0.5	1.0

## ABSOLUTE MAXIMUM RATINGS<sup>1</sup>

(T<sub>c</sub> = 25°C, unless otherwise specified)

SYMBOLS	PARAMETERS	UNITS	RATINGS
P <sub>f</sub>	Optical Output Power from Fiber	mW	3.0
I <sub>F</sub>	Forward Current of LD	mA	150
V <sub>R</sub>	Reverse Voltage of LD	V	2.0
I <sub>F</sub>	Forward Current of PD	mA	10
V <sub>R</sub>	Reverse Voltage of PD	V	20
T <sub>c</sub>	Operating Case Temperature	°C	-40 to +85
T <sub>STG</sub>	Storage Temperature	°C	-40 to +85
T <sub>SLD</sub>	Lead Soldering Temperature (10 s)	°C	260
RH	Relative Humidity (noncondensing)	%	85

Note:

1. Operation in excess of any one of these parameters may result in permanent damage.

## PARAMETER DEFINITIONS

**Kink : kink**

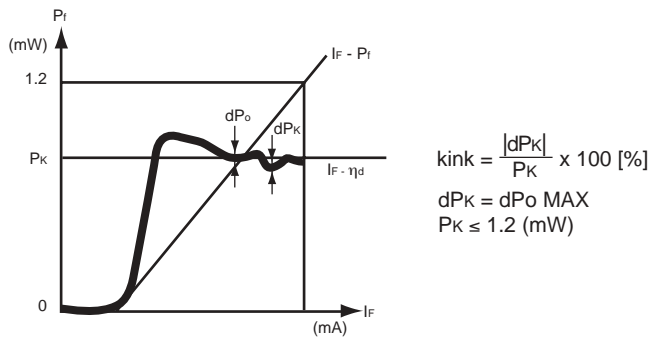

**Linearity : LINm**

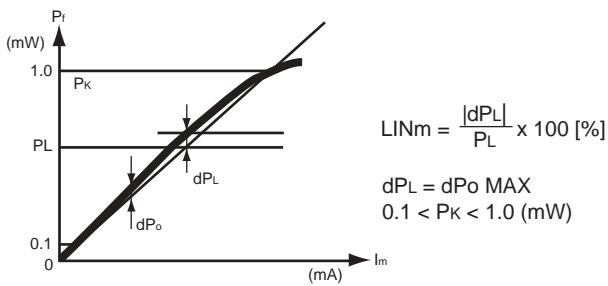

**Tracking Error : γ**

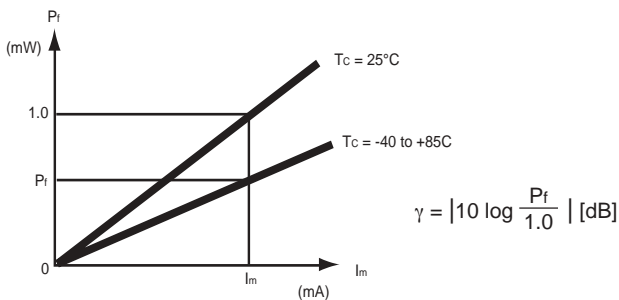

**TYPICAL PERFORMANCE CURVES** ( $T_c = -40$  to  $+85^\circ\text{C}$ , unless otherwise specified)

**OPTICAL OUTPUT POWER FROM FIBER vs. FORWARD CURRENT**

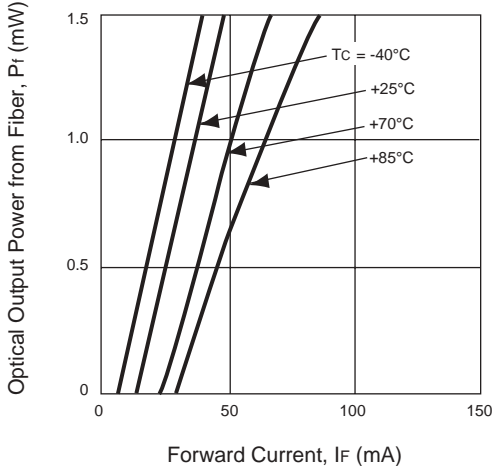

**OPERATING CURRENT AND THRESHOLD CURRENT vs. CASE TEMPERATURE**

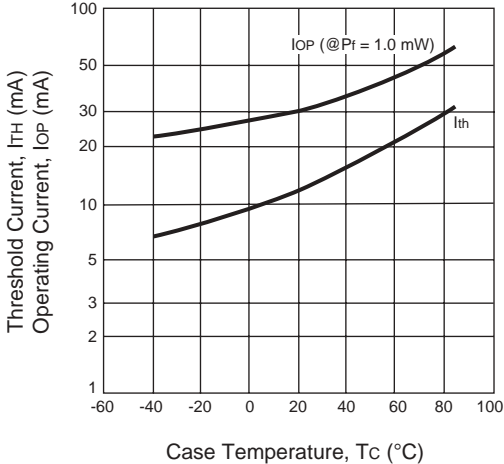

**TEMPERATURE DEPENDENCE OF CENTER WAVELENGTH**

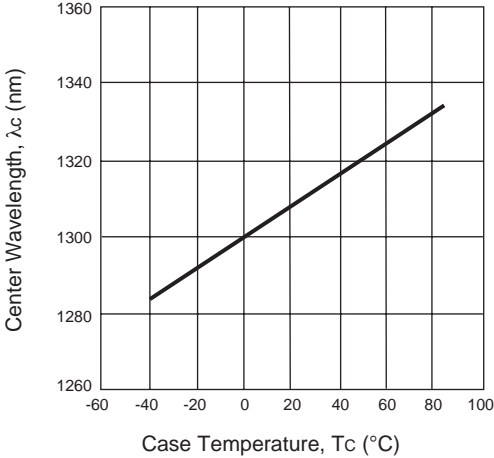

**TEMPERATURE DEPENDENCE OF DIFFERENTIAL EFFICIENCY**

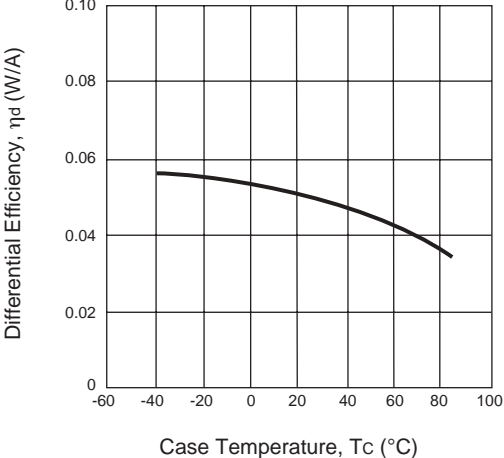

**LONGITUDINAL MODE**

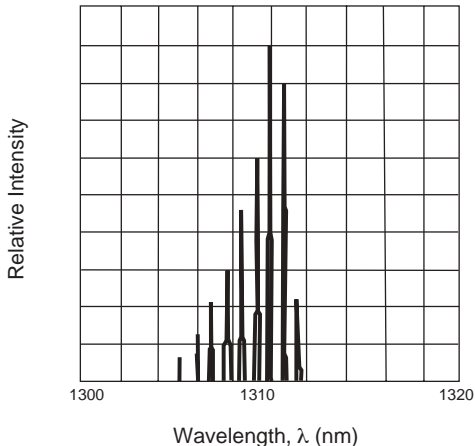

**OPTICAL OUTPUT POWER FROM FIBER vs. MONITOR CURRENT**

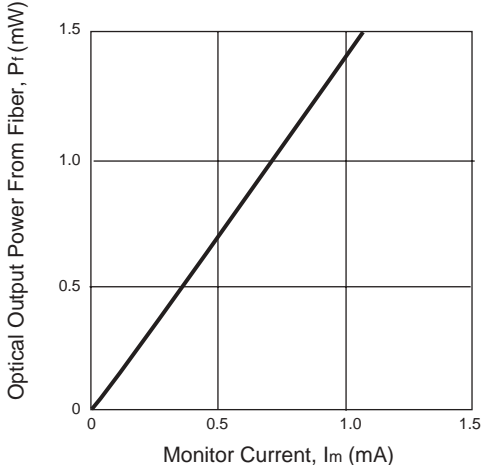

**TYPICAL PERFORMANCE CURVES**

(Tc = -40 to +85°C, unless otherwise specified)

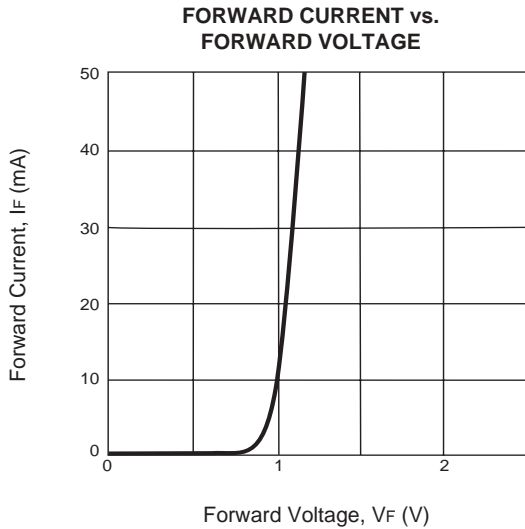

**ORDERING INFORMATION**

PART NUMBER	AVAILABLE CONNECTOR	FLANGE TYPE
NX7303BA-CC	With SC-UPC Connector	Flat Mount Flange
NX7303CA-CC	With SC-UPC Connector	Vertical Mount Flange

**OPTICAL FIBER CHARACTERISTICS**

PARAMETER	UNITS	SPECIFICATION
Mode Field Diameter	μm	9.5±1
Cladding Diameter	μm	125±2
Maximum Cladding Noncircularity	%	2
Maximum Core/Cladding Concentricity	%	1.6
Outer Diameter	mm	0.9±0.1
Cut-off Wavelength	nm	1100 to 1270
Minimum Fiber Bending Radius	mm	30
Fiber Length	mm	500±50
Flammability		UL 1581 VW-1

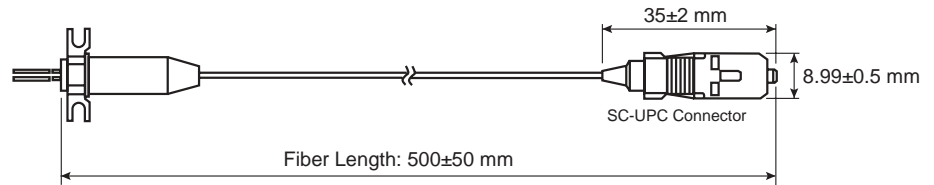

**OUTLINE DIMENSIONS (Units in mm)**

**NX7303BA-CC**

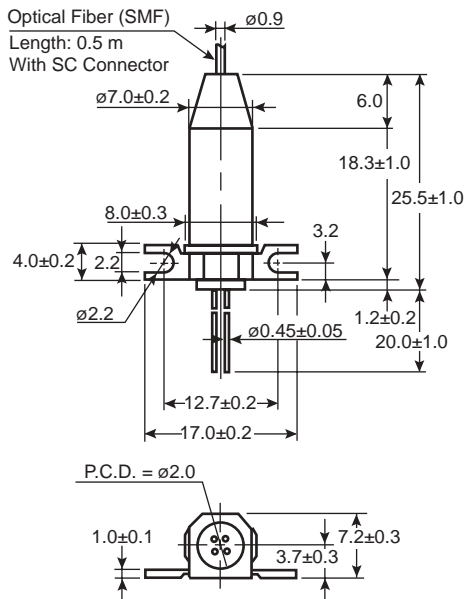

**NX7303CA-CC**

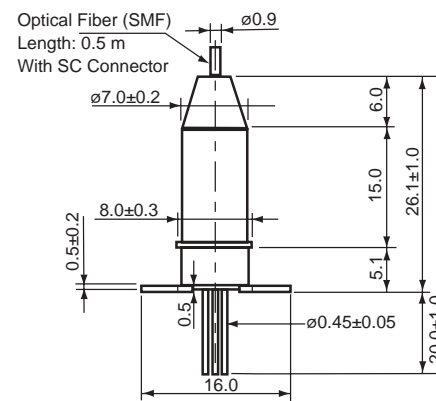

**PIN CONNECTIONS**



**PIN CONNECTIONS**

