



ATTENTION
 OBSERVE PRECAUTIONS
 FOR HANDLING
 ELECTROSTATIC
 DISCHARGE
 SENSITIVE
 DEVICES

Part Number: KPFA-3011BZ1RGZ1C-132/F

Blue
 Hyper Red
 Green

Features

- 3.0x1.5x1.0mm right angle SMD LED, 1.0mm thickness.
- Low power consumption.
- Wide viewing angle.
- Ideal for backlight and indicator.
- Package : 2000pcs / reel.
- Moisture sensitivity level : level 3.
- RoHS compliant.

Descriptions

- The Blue source color devices are made with InGaN Light Emitting Diode.
- The Hyper Red device is based on light emitting diode chip made from AlGaInP.
- The Green source color devices are made with InGaN Light Emitting Diode.
- Electrostatic discharge and power surge could damage the LEDs.
- It is recommended to use a wrist band or anti-electrostatic glove when handling the LEDs.
- All devices, equipments and machineries must be electrically grounded.

Package Dimensions

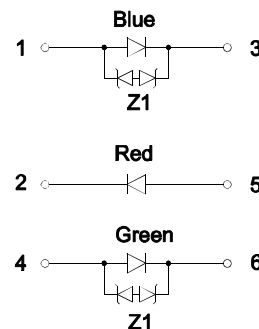
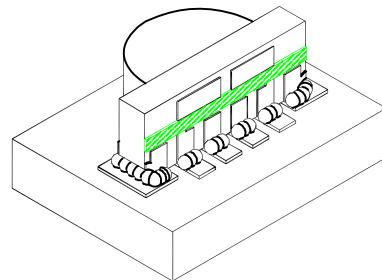
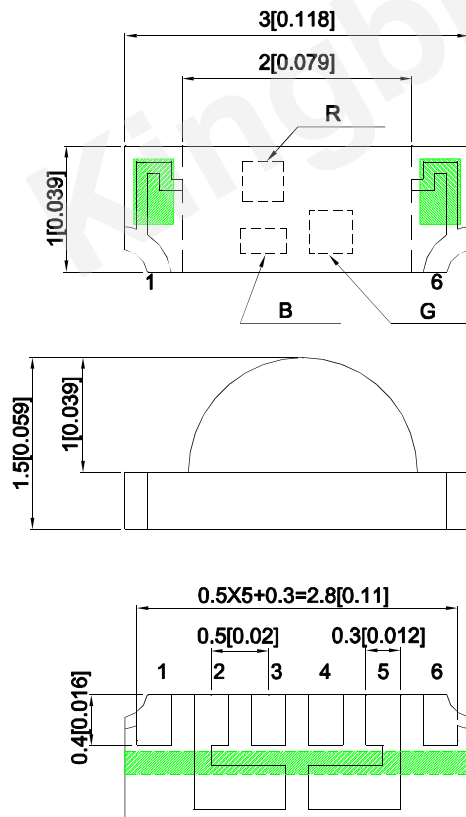

Notes:

1. All dimensions are in millimeters (inches).
2. Tolerance is $\pm 0.2(0.008)$ unless otherwise noted.
3. The specifications, characteristics and technical data described in the datasheet are subject to change without prior notice.
4. The device has a single mounting surface. The device must be mounted according to the specifications.



Selection Guide

Part No.	Emitting Color (Material)	Lens Type	Iv (mcd) [2] @ 20mA		Iv (mcd) [2] @B:R:G=18.9mA:10.6mA:20mA	Dice Chromaticity Coordinates		Viewing Angle [1]
			Min.	Typ.	Typ.	X(Typ.)	Y(Typ.)	2θ1/2
KPFA-3011BZ1RGZ1C-132/F	Blue (InGaN)	Water Clear	55	110	1270	0.3	0.3	150°
	Hyper Red (AlGaInP)		400	660				
	Green (InGaN)		500	780				

Notes:

1. θ1/2 is the angle from optical centerline where the luminous intensity is 1/2 of the optical peak value.
2. Luminous intensity / luminous Flux: +/-15%.
3. Luminous intensity value is traceable to CIE127-2007 standards.

Electrical / Optical Characteristics at T_A=25°C

Parameter	Condition	Symbol	Value			Unit
			B	R	G	
Wavelength at Peak emission	I _F =20mA	λ peak	465	631	520	nm
Dominant Wavelength [1]	I _F =20mA	λ dom	470	624	525	nm
Spectral bandwidth at 50%Φ _{REL} MAX	I _F =20mA	Δλ	22	20	35	nm
Forward Voltage [2]	I _F =20mA	V _F [typ.] V _F [max.]	3.3 4.0	2.1 2.5	3.2 4.0	V
Reverse Current	V _R =5V	I _R [max.]	10	10	10	uA

Notes:

1. Wavelength: +/-1nm.
2. Forward Voltage: +/-0.1V.
3. Wavelength value is traceable to CIE127-2007 standards.
4. Excess driving current and/or operating temperature higher than recommended conditions may result in severe light degradation or premature failure.

Absolute Maximum Ratings at T_A=25°C

Parameter	Symbol	Value			Unit
		B	R	G	
Operating Temperature	Top	-40 To +85			°C
Storage Temperature	Tstg	-40 To +100			°C
Junction Temperature	T _J	100	100	100	°C
Power dissipation	P _D	120	175	120	mW
Total Power dissipation [3]	P total	240			mW
DC Forward Current [1]	I _F	30	70	30	mA
Peak Forward Current [2]	I _{FM}	100	200	100	mA
Reverse Voltage	V _R	5	5	5	V
Electrostatic Discharge Threshold (HBM)		8000	3000	8000	V
Junction/ambient 1 chip on	Rthj-a	290	400	400	°C/W
Junction/ambient 3 chip on	Rthj-a	630	590	610	°C/W

Notes:

1. Single-color light
2. 1/10 Duty Cycle, 0.1ms Pulse Width.
3. Value for total power dissipation when two and more chips are lit simultaneously.
4. Relative humidity levels maintained between 40% and 60% in production area are recommended to avoid the build-up of static electricity – Ref JEDEC/JESD625-A and JEDEC/J-STD-033.

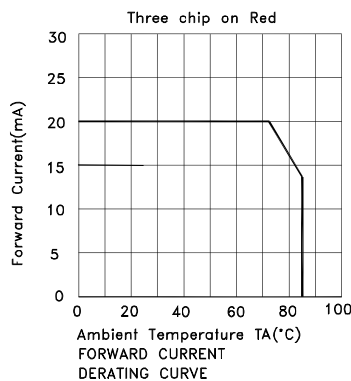
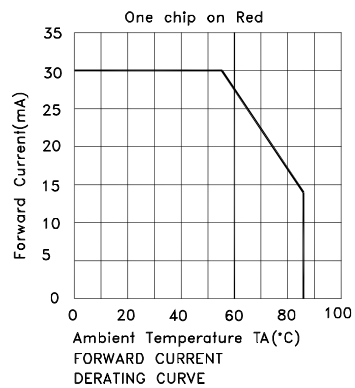
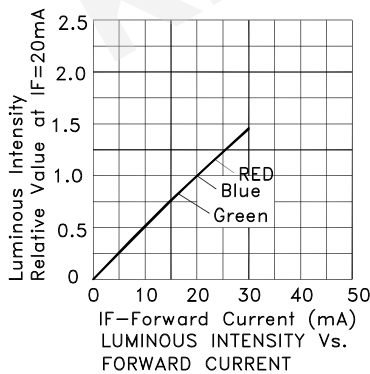
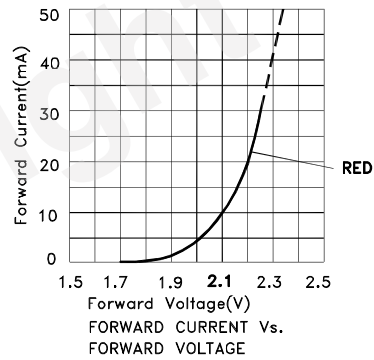
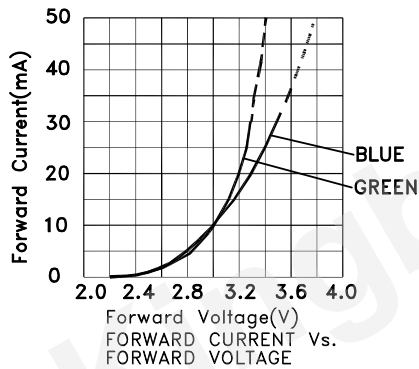
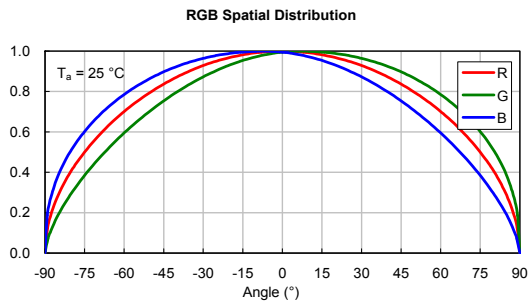
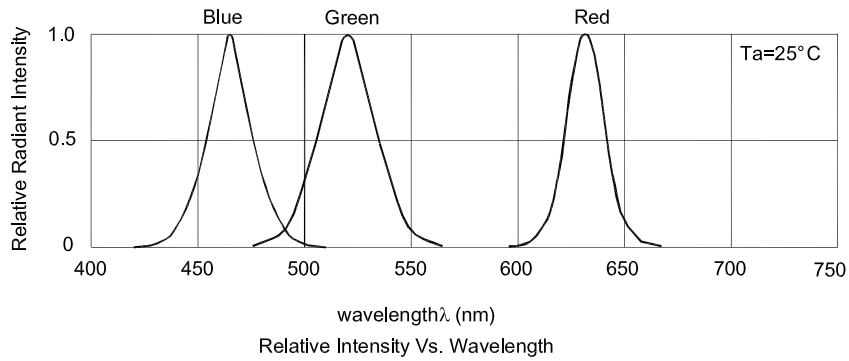

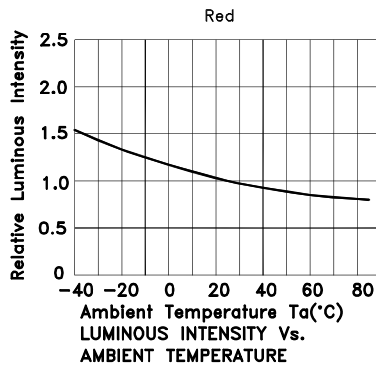
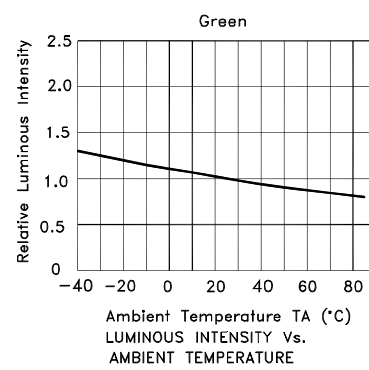
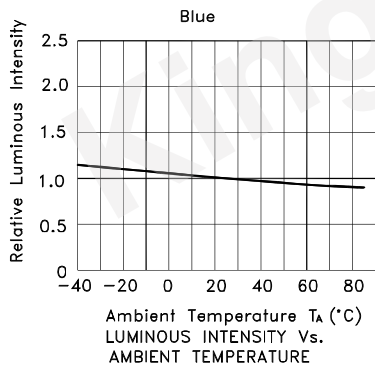
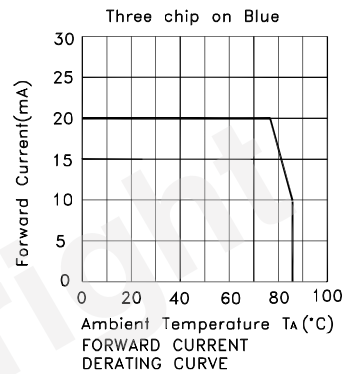
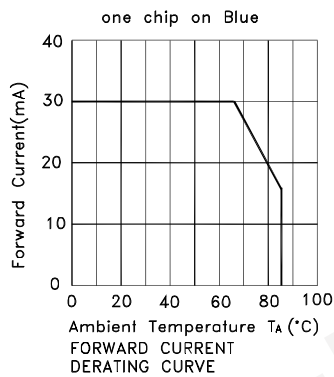
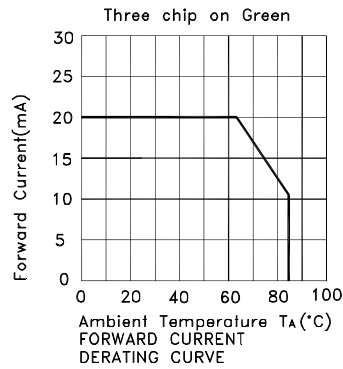
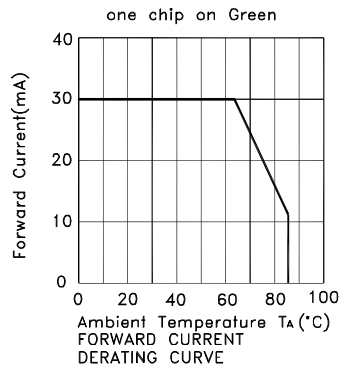

Full color (White Rank)

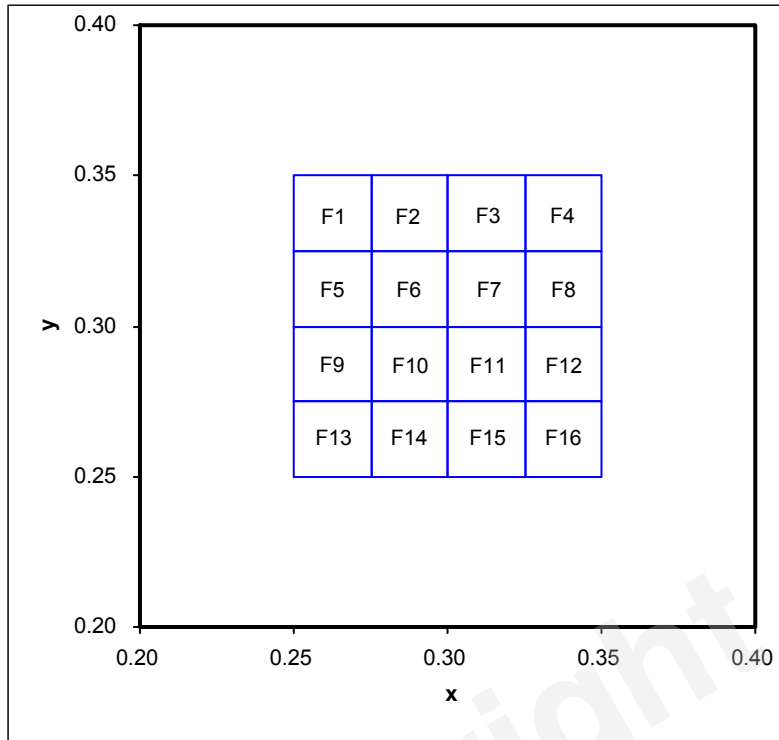

F1		F2		F3		F4	
x	y	x	y	x	y	x	y
0.250	0.325	0.275	0.325	0.300	0.325	0.325	0.325
0.275	0.325	0.300	0.325	0.325	0.325	0.350	0.325
0.275	0.350	0.300	0.350	0.325	0.350	0.350	0.350
0.250	0.350	0.275	0.350	0.300	0.350	0.325	0.350
F5		F6		F7		F8	
x	y	x	y	x	y	x	y
0.250	0.300	0.275	0.300	0.300	0.300	0.325	0.300
0.275	0.300	0.300	0.300	0.325	0.300	0.350	0.300
0.275	0.325	0.300	0.325	0.325	0.325	0.350	0.325
0.250	0.325	0.275	0.325	0.300	0.325	0.325	0.325
F9		F10		F11		F12	
x	y	x	y	x	y	x	y
0.250	0.275	0.275	0.275	0.300	0.275	0.325	0.275
0.275	0.275	0.300	0.275	0.325	0.275	0.350	0.275
0.275	0.300	0.300	0.300	0.325	0.300	0.350	0.300
0.250	0.300	0.275	0.300	0.300	0.300	0.325	0.300
F13		F14		F15		F16	
x	y	x	y	x	y	x	y
0.250	0.250	0.275	0.250	0.300	0.250	0.325	0.250
0.275	0.250	0.300	0.250	0.325	0.250	0.350	0.250
0.275	0.275	0.300	0.275	0.325	0.275	0.350	0.275
0.250	0.275	0.275	0.275	0.300	0.275	0.325	0.275

Notes:
 Shipment may contain more than one chromaticity regions.
 Orders for single chromaticity region are generally not accepted.
 Measurement tolerance of the chromaticity coordinates is ± 0.01 .

KPFA-3011BZ1RGZ1C-132/F

Reflow soldering is recommended and the soldering profile is shown below.
Other soldering methods are not recommended as they might cause damage to the product.

Reflow Soldering Profile For Lead-free SMT Process.

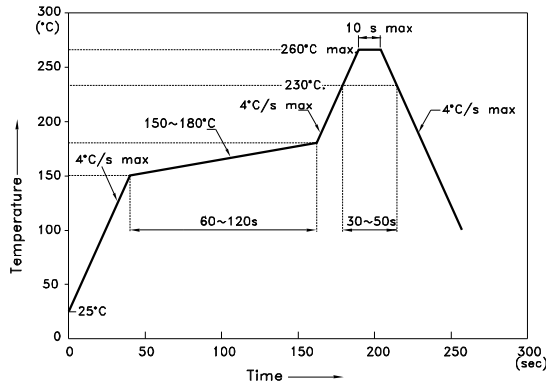

NOTES:

1. We recommend the reflow temperature 245°C(+/-5°C). The maximum soldering temperature should be limited to 260°C.
2. Don't cause stress to the epoxy resin while it is exposed to high temperature.
3. Number of reflow process shall be 2 times or less.

Recommended Soldering Pattern (Units : mm; Tolerance: ± 0.1)

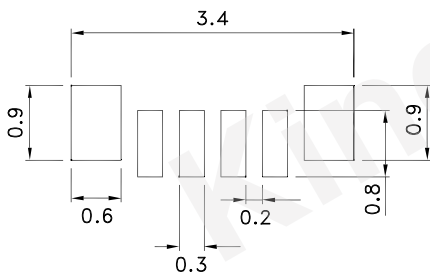

Reel Dimension

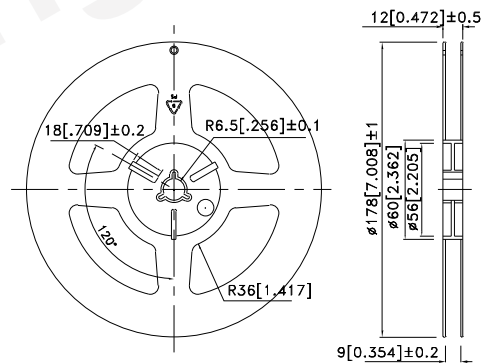

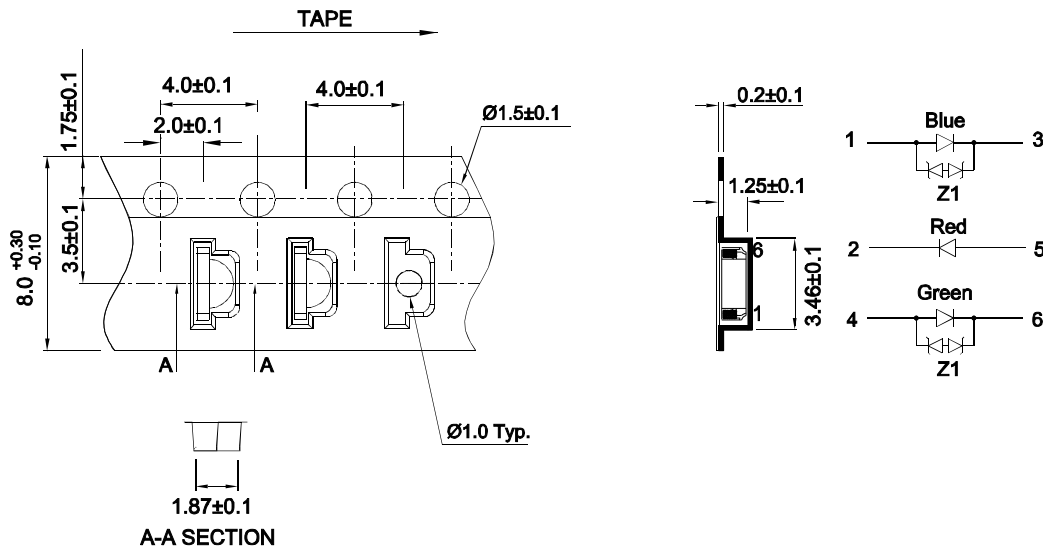

Tape Dimensions (Units : mm)

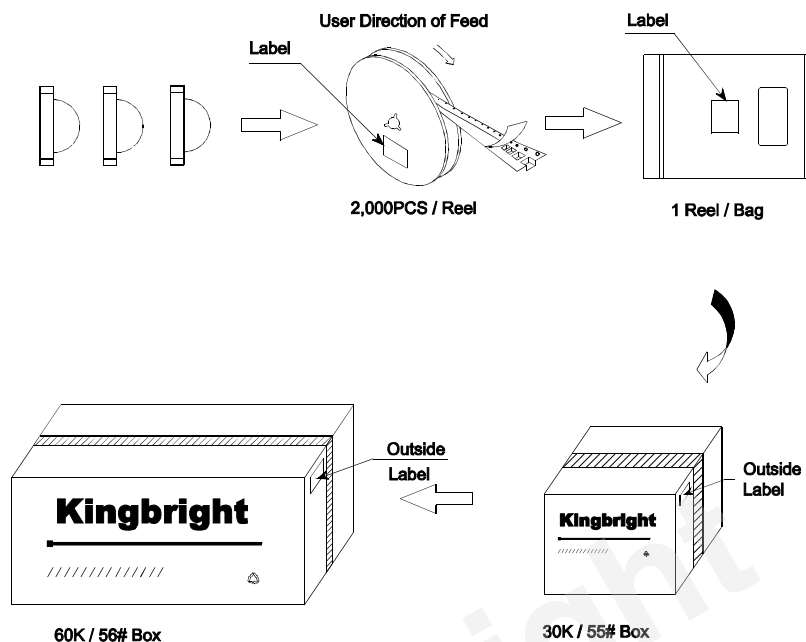

PACKING & LABEL SPECIFICATIONS

KPFA-3011BZ1RGZ1C-132/F



Kingbright		
P/NO: KPFA-3011xxx		
QTY: 2,000 PCS	Q.C.	Q C xxxxxxx PASSED
S/N: XXXX		
CODE: XXX		
LOT NO:		
		
RoHS Compliant		

Terms and conditions for the usage of this document

1. The information included in this document reflects representative usage scenarios and is intended for technical reference only.
2. The part number, type, and specifications mentioned in this document are subject to future change and improvement without notice. Before production usage customer should refer to the latest datasheet for the updated specifications.
3. When using the products referenced in this document, please make sure the product is being operated within the environmental and electrical limits specified in the datasheet. If customer usage exceeds the specified limits, Kingbright will not be responsible for any subsequent issues.
4. The information in this document applies to typical usage in consumer electronics applications. If customer's application has special reliability requirements or have life-threatening liabilities, such as automotive or medical usage, please consult with Kingbright representative for further assistance.
5. The contents and information of this document may not be reproduced or re-transmitted without permission by Kingbright.
6. All design applications should refer to Kingbright application notes available at http://www.kingbright.com/application_notes