

Plug-in Signal Conditioners M-UNIT

PULSE ACCUMULATOR

(field-programmable; built-in excitation)

Functions & Features

- Generates a DC voltage or current output proportional to the total number of input pulses
- Built-in excitation
- Pulse count programmable to the full-scale DC signal range
- Field-selectable input type: Open collector, mechanical contact, voltage pulse or two-wire current pulse
- Isolation up to 2000 V AC
- High-density mounting

Typical Applications

- Totalizing a flow to give volume or mass delivered
- Measuring moving distance of a machine with pulse signals

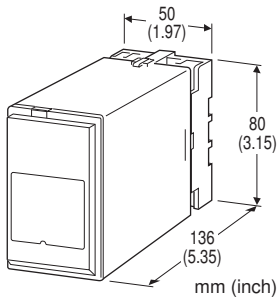

MODEL: JPQ2-[1][2]-[3][4]

ORDERING INFORMATION

- Code number: JPQ2-[1][2]-[3][4]
- Specify a code from below for each of [1] through [4].
(e.g. JPQ2-76-K/Q)
- Special output range (For codes Z & 0)
 - Use Ordering Information Sheet (No. ESU-1579). Factory setting (table below) will be used if not otherwise specified.
 - Specify the specification for option code /Q
(e.g. /C01/S01)

Factory Setting

Input type	Open collector, mechanical contact
Pulse amplitude	----
Noise filter	None
Detecting level	2V*
Count mode	Count at pulse rise
Input zero count	0
Input span count	1000
Alarm setpoint	100%
Alarm mode	High alarm
Overflow mode	Hold at 115% (1150 counts)
Linearization	Without
Input count at power off	Not held (Cold Start)

*Detecting voltage in the internal circuit

INPUT - Field-selectable

Open collector
Mechanical contact
Voltage pulse
Two-wire current pulse

[1] EXCITATION

- 1: 5 V DC @ 120 mA
- 4: 12 V DC @ 60 mA
- 7: 24 V DC @ 25 mA

[2] OUTPUT

Current

- A: 4 - 20 mA DC (Load resistance 750 Ω max.)
- B: 2 - 10 mA DC (Load resistance 1500 Ω max.)
- C: 1 - 5 mA DC (Load resistance 3000 Ω max.)
- D: 0 - 20 mA DC (Load resistance 750 Ω max.)
- E: 0 - 16 mA DC (Load resistance 900 Ω max.)
- F: 0 - 10 mA DC (Load resistance 1500 Ω max.)
- G: 0 - 1 mA DC (Load resistance 15 kΩ max.)
- Z: Specify current (See OUTPUT SPECIFICATIONS)

Voltage

- 1: 0 - 10 mV DC (Load resistance 10 kΩ min.)
- 2: 0 - 100 mV DC (Load resistance 100 kΩ min.)
- 3: 0 - 1 V DC (Load resistance 100 Ω min.)
- 4: 0 - 10 V DC (Load resistance 1000 Ω min.)
- 5: 0 - 5 V DC (Load resistance 500 Ω min.)
- 6: 1 - 5 V DC (Load resistance 500 Ω min.)
- 4W: -10 - +10 V DC (Load resistance 2000 Ω min.)
- 5W: -5 - +5 V DC (Load resistance 1000 Ω min.)
- 0: Specify voltage (See OUTPUT SPECIFICATIONS)

[3] POWER INPUT

AC Power

K: 85 - 132 V AC

DC Power

S: 12 V DC
 R: 24 V DC
 V: 48 V DC
 P: 110 V DC

[4] OPTIONS

blank: none

/Q: With options (specify the specification)

SPECIFICATIONS OF OPTION: Q (multiple selections)

COATING (For the detail, refer to M-System's web site.)

/C01: Silicone coating

/C02: Polyurethane coating

/C03: Rubber coating

TERMINAL SCREW MATERIAL

/S01: Stainless steel

RELATED PRODUCTS

- Programming Unit (model: PU-2x)
- PC configurator software (model: JXCON)

Downloadable at M-System's web site.

A dedicated cable is required to connect the module to the PC. Please refer to the internet software download site or the users manual for the PC configurator for applicable cable types.

GENERAL SPECIFICATIONS

Construction: Plug-in

Connection: M3.5 screw terminals

Screw terminal: Chromated steel (standard) or stainless steel

Housing material: Flame-resistant resin (black)

Isolation: Input to DC output to alarm output to power

Overrange output: Approx. -15 to +115 % at 1 - 5 V

Zero adjustment: -5 to +5 % (front)

Span adjustment: 95 to 105 % (front)

Alarm mode: High

Alarm setpoint: -15 - +115 %

Linearization: Max. 16 points

Input monitor LED: Red LED blinks according to the input.

Excitation adjustment: 5 - 24 V DC

Software programming: Programming Unit (model: PU-2x); (Refer to the users manual of JXCON for the adjustments configurable with JXCON)

- Zero and span
- Linearization
- Alarm setpoint
- Output fine adjustment
- Others

Adjustments: With DIP and Rotary switches.

- Pulse amplitude
- Input type
- Noise filter

(Refer to the instruction manual for details)

Modular jack: Connecting the PU-2x

Input pulse sensing: DC coupled

Reset input: Resets the internal counter value (The transmitter output equivalent to 0 count when the reset input terminals are closed for 500 msec. or longer.)

Output at count overflow: Reset (restart at 0 count), Hold at 100 % count or 115 % count

INPUT SPECIFICATIONS

Excitation: Shortcircuit protection; approx. 440 mA (max.) at shortcircuit

Maximum frequency: 100 kHz

(10 Hz for mechanical contact)

Maximum count range: 0 to 99999999

Minimum pulse width time requirement: 5 μ sec.; 50 msec.

for mechanical contact

(for both ON and OFF)

■ Open Collector & Mechanical Contact

Input requirements

(Excitation: Sensing)

5 V: Approx. 4 V / 1.0 mA

12 V: Approx. 9 V / 2.3 mA

24 V: Approx. 16 V / 4.7 mA

ON resistance: \leq 200 Ω

OFF resistance: \geq 200 k Ω

Detecting level: 2 V (Detecting voltage in the internal circuit.)

Detecting pulse edge: OFF (input monitor LED ON) to ON (input monitor LED OFF) or ON to OFF

■ Voltage Pulse

Waveform: Square or sine

Input impedance: 10 k Ω min.

Pulse amplitude: 0.1 - 100 V p-p (1 - 100 Vp-p for sine or similar waveforms)

Max. voltage between input terminals: 50 V

Detecting level: 0 - 5 V (factory setting: 2 V)

Detecting voltage in the internal circuit.

Detecting pulse state: A pulse rise detected when the input voltage goes above the detecting level (input monitor LED ON); a pulse sink detected when it goes below the level (input monitor LED OFF).

■ Two-wire Current Pulse

Input resistance: Receiving resistor 100 Ω

Input range: 0 - 25 mA

Minimum pulse amplitude: 10 mA

Detecting level: 0 - 5 V

(Detecting voltage in the internal circuit.)

Detecting pulse state: The input resistor (100 Ω) converts

the current signal (0 - 25 mA) into 0 - 2.5 V. A pulse rise detected when the voltage goes above the detecting level (input monitor LED ON); a pulse sink detected when it goes below the level (input monitor LED OFF).

■ **Reset Input**

Sensing voltage: 4.5 V DC

Detecting level

ON: ≤ 1 V

OFF: ≥ 4 V

■ **Voltage pulse waveform**

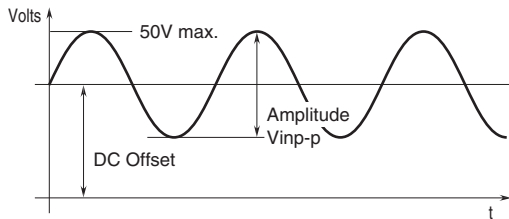

PERFORMANCE in percentage of span

Accuracy: ±0.1 %

Temp. coefficient: ±0.015 %/°C (±0.008 %/°F)

Response time: ≤ 0.5 sec. (0 - 90 %)

Line voltage effect: ±0.1 % over voltage range

Insulation resistance: ≥ 100 MΩ with 500 V DC

Dielectric strength:

2000 V AC @ 1 minute (input to output to power)

1500 V AC @ 1 minute (input or output or power to alarm output)

2000 V AC @ 1 minute (circuit to ground)

OUTPUT SPECIFICATIONS

■ **DC Current:** 0 - 20 mA DC

Minimum span: 1 mA

Offset: Max. 1.5 times span

Load resistance: Output drive 15 V max.

■ **DC Voltage:** -10 - +12 V DC

Minimum span: 5 mV

Offset: Max. 1.5 times span

Load resistance: Output drive 10 mA max.; 5 mA for negative voltage output; at ≥ 0.5 V

■ **Alarm Output:** Relay contact

Rated load: 125 V AC @ 0.5 A (cos φ = 1)

30 V DC @ 0.5 A (resistive load)

Maximum switching voltage: 250 V AC or 125 V DC

Maximum switching power: 62.5 VA or 60 W

Minimum load: 10 mV DC @ 1 mA

Mechanical life: 5 × 10⁷ cycles (300 cycles/minute)

For maximum relay life with inductive loads, external protection is recommended.

INSTALLATION

Power input

• **AC:** Operational voltage range 85 - 132 V, 47 - 66 Hz, approx. 6 VA

• **DC:** Operational voltage range: Rating ±10 %, or 85 - 150 V for 110 V rating; ripple 10 %p-p max.; Approx. 3.3 W (130 mA at 24 V)

Operating temperature: -5 to +60°C (23 to 140°F)

Operating humidity: 30 to 90 %RH (non-condensing)

Mounting: Surface or DIN rail

Weight: 350 g (0.77 lb)

EXTERNAL VIEW

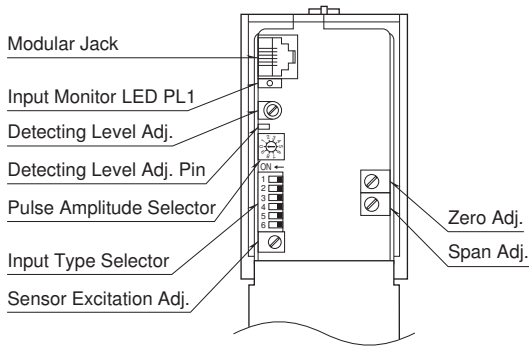

Refer to the instruction manual for detailed procedures.

EXTERNAL DIMENSIONS & TERMINAL ASSIGNMENTS unit: mm (inch)

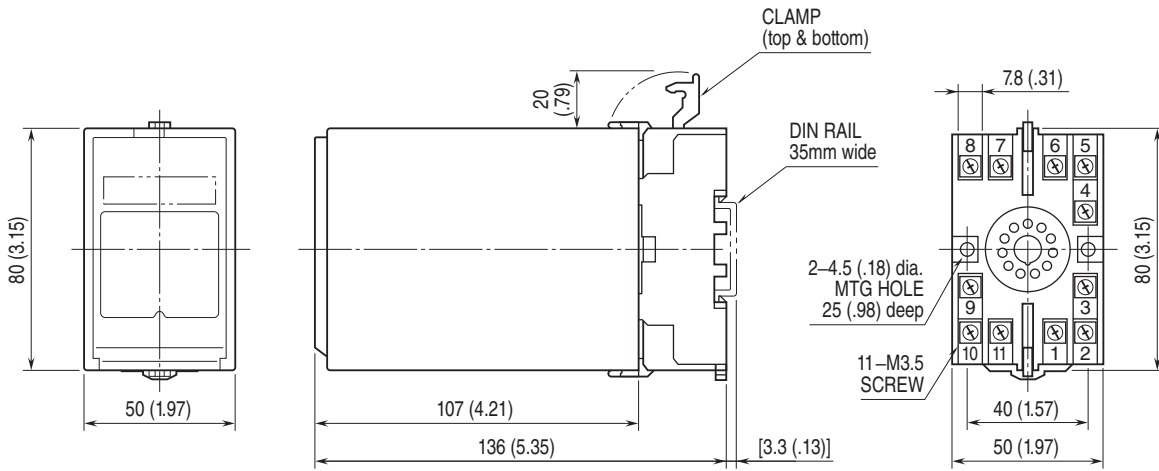

• When mounting, no extra space is needed between units.

SCHEMATIC CIRCUITRY & CONNECTION DIAGRAM

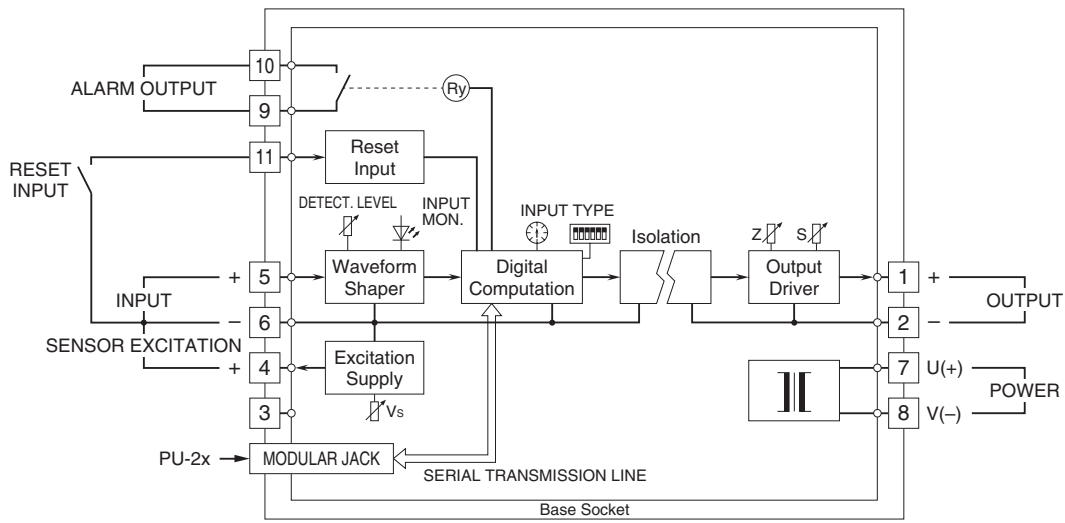

Input Connection Examples

■ Open Collector or Mechanical Contact

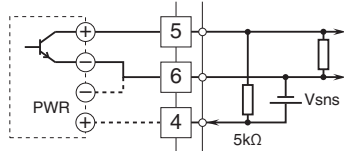

■ 2-Wire Current Pulse

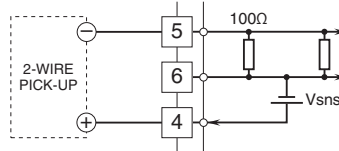

■ Voltage Pulse

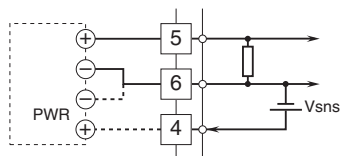

■ External DC Supply

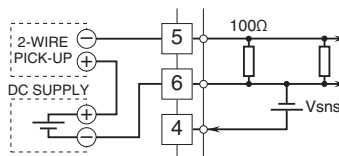

Specifications are subject to change without notice.